

User Guide

Monitoring unit with alarm function and data collection

AK-SM 350

ADAP-KOOL® Refrigeration control systems



Introduction

The AK-SM 350 is a combined data collection and monitoring unit for use in refrigeration plant in small supermarkets.

It is used to record the temperature in the various refrigeration applications, store this data and then present it as documentation in compliance with regulatory requirements.

Along with recording temperatures, there are alarm limit settings and the unit will emit an alarm if a threshold value is exceeded.

The alarm is presented on the display and it can be sent to an external alarm destination such as a mobile phone or a service company.

The unit is positioned centrally in the supermarket, and the user-friendly interface makes it easy to follow the different temperature readings.

With just a few pushes of the buttons, graphs of the different temperature sequences can be brought up, and in the event of an alarm, the cause can be read from the display.

All store employees will be able to operate the monitoring unit and authorised personnel will have access to important settings with a password.

Setups and settings can be entered via the front panel, but if there are a lot of names and settings, they can be entered using the AK-ST type software. This software must be loaded on to a PC.

If there is more than one AK-SM 350 that is to be programmed with the same settings, the back-up and restore function in the AK-ST software may prove useful.



Advantages

- Compact unit for registration of temperatures
- Collects temperature data to present to authorities
- System unit with
 - Optimisation of suction pressure (P0 optimisation)
 - Day/night override
 - Alarm function

Contents

Overview	3	Configuration settings	21
Data	6	Basic setup	21
AK-SM 350	6	Setup of points	24
Installation	8	Alarm settings	33
Assembly	8	Alarm routes	34
Connections	9	Alarm destinations	36
External communication	12	Print setup	40
Configuration	13	IP configuration	41
The functions' mode of operation	14	Relay configuration	41
The display	14	Setup for other networks via protocol interface	43
The overview display	14	Alarm priorities	43
Display screens for daily use	15	Daily use	44
Main menu	15	When there is an alarm	44
Functions for daily use - Setups/adjustments	16	When you want to print out a data collection	45
Day / Night setup	16	When you want to see a graph of the collected temperatures	46
Injection ON Signal	17	When you want to change the store's opening times	47
Starting defrosts	18	When you want to change the defrost times	48
Adaptive defrost	19	Appendix - Template compiler	49
P0 optimization	19	Menu survey	53
Adaptive Rail heat	20		

Overview

Number of connections

The AK-SM 350 is a central monitoring unit that can monitor up to 65 readings. They can originate from:

- up to 16 direct connections from sensors or switch functions
- signals from separate refrigeration controllers, EKC and AK types, via data communication and AKC via interface AK-PI 200.
- signals from gas detectors. These readings are also transferred via data communication.

Alarms

The unit advises you of an alarm in several ways:

- With an audio signal
- By flashing the LED on the front
- By showing an alarm symbol on the display
- In addition to this, the unit can route alarms to external alarm destinations. This alarm routing can be categorised into priorities and times for different alarm destinations at different times of the day.

Alarms from freestanding refrigeration controllers received via data communication are forwarded to the monitoring unit. The warnings are then generated as described above.

Data collection

All defined points can be recorded and saved with the set time intervals.

The values can be viewed on the display and retrieved by connecting a printer or connecting a PC or modem.

Signals

The following types of signals can be received:

- Temperature readings
- Switch functions
- Pulse signal for output reading
- Voltage signal
- Current signal
- Signals from refrigeration controllers types EKC and AK.
- Signals for P0 optimization
- Day/night override.

Gas detector

One or more of the measuring points can be a gas detector. The gas detector is connected to the data communication, after which it will send the measured value to the monitoring unit. If the threshold value set in the monitoring unit is exceeded an alarm is generated.

For further information on the gas detector, please see document RD7HA or USCO.EN.S00.A.

Printer

The connection of a printer means that the data collected can be printed out. The printer must be an HP PCL-3 compatible printer. The print-out may contain:

- The measuring points' actual values
- Graphic readout of temperature sequences
- Alarm history

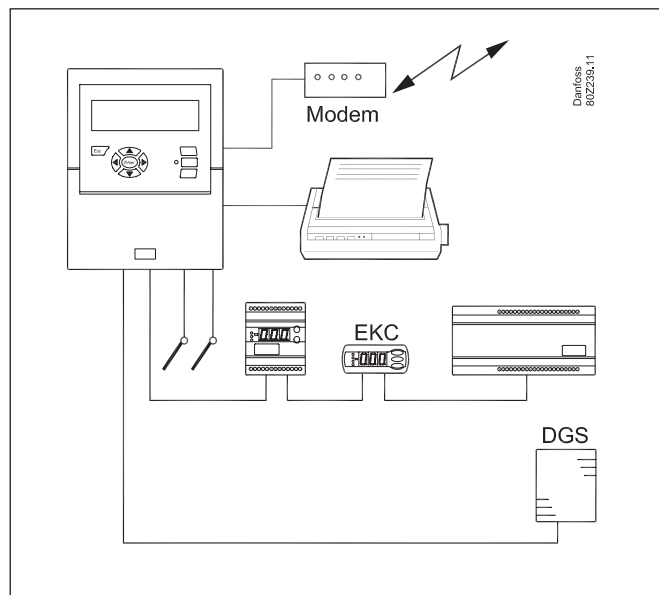

External connections

- Modem
 - A modem can be connected so that the unit can be in contact with external alarm destinations or service companies. The modem can be a standard telephone modem or a GSM modem for mobile telephony.
- Ethernet
 - The link to external alarm destinations and service companies can take place via a TCP/IP network.
- PC
 - A PC can be connected to the unit. The PC may be stationary, portable or handheld. Setups and/or alarm receipt can be performed via an operating program.
- Service companies
 - Users of the following programs can receive alarm calls from the unit.
 - AK series software (operating and setting)
 - AKM type software (only receiving alarms and logging data)

Security

Important settings are password-protected. When logging on or out from external links, an additional security check is required to verify the connection. This will be carried out during the setup.

Battery Backup

The unit contains a battery, so that the clock function is still maintained if there is a power failure.

The recording of temperatures will resume when the power comes back on.

All setups will be retained during a power failure.

Operation

The following operation options are found on the front of the monitoring unit:

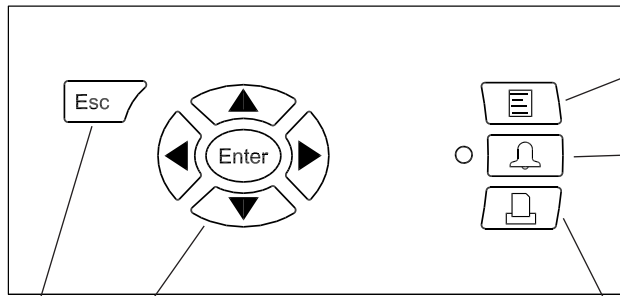

Escape
 • Goes back to the display readout

Navigation
 • The arrow keys change what is highlighted in the display. Values can be changed.
 • "Enter" executes a selection.

Menu
 Provides access to the menu system and consequently the setups. See page 15 for more information.

Alarm signal and operating the alarms
 • The LED flashes when there is a new alarm
 • The LED lights up when the alarm is acknowledged and the "error" has not been dealt with.
 • The LED does not go out until the error has both been rectified and acknowledged.
 • The button shows the alarm text and stops the alarm signal when it is pressed twice.
 See overleaf for more information.

Print
 • Starts the print-out function. Only used if a printer is connected to the unit.
 See page 40 for more information.

When an "arrow" is shown on the top right-hand side of the display, this means there are several menus for this level. Press an arrow key to move to the menu.

The display

There are several display screens used in daily operation. Here is a short presentation:

• Overview display, with all measuring point

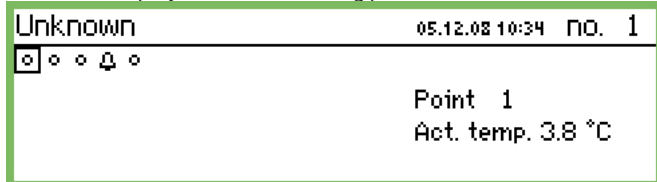

• Graph display, showing the point's previous readings

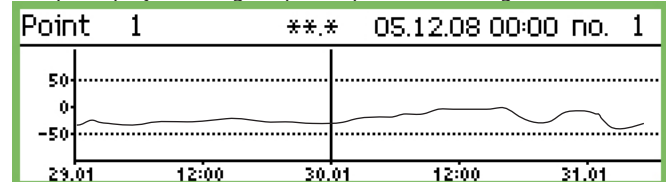

• Point detail display, showing the point's actual values

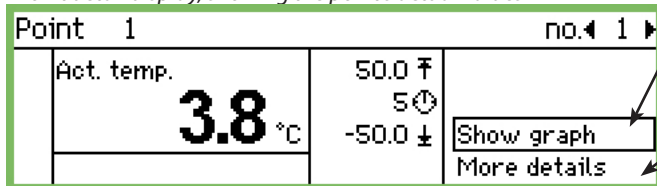

• "More details" from a point

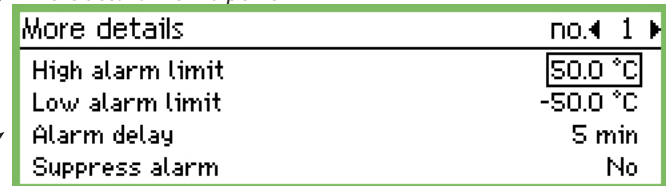

• Point detail display from a controller

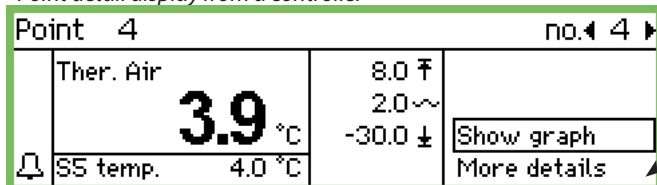

• "More details" from a controller

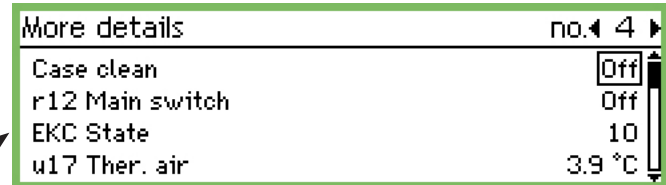

Descriptions of the display screens can be found on page 14 onwards.

Alarm situations

If there is an alarm, the following will happen:

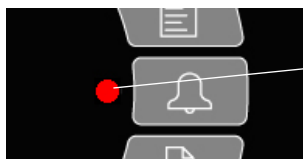

Flashes

Shows alarm symbol

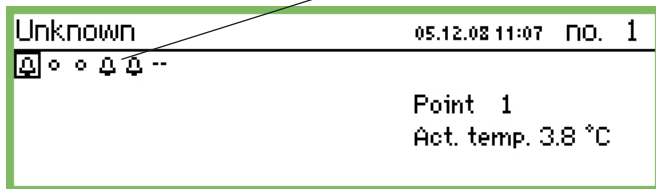

- An alarm symbol will appear in the overview display for the point in question
- The LED by the alarm button will flash
- The built-in siren will be activated for a set period (but only if it has been defined)
- If a relay to the alarm function has been defined, the relay will be enabled

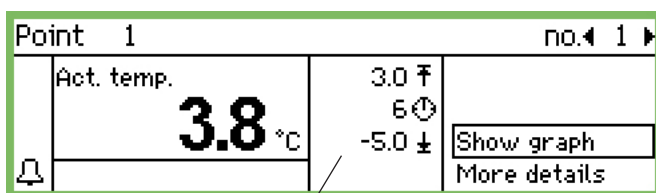

This area shows the alarm limits and delay time

- When you move to the point in question, the alarm symbol will also be visible at the bottom left-hand side
- The alarm text is entered into the alarm list of active alarms
- If external alarm destinations have been defined, the alarm and alarm text will be forwarded to the destination.

If you press the alarm button:

- The alarm list is shown in the display

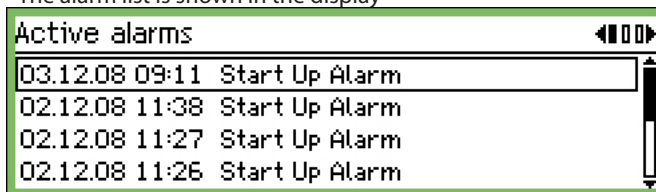

When you select an alarm from the alarm list of active alarms and then press "Enter", you will see several pieces of information about the alarm.

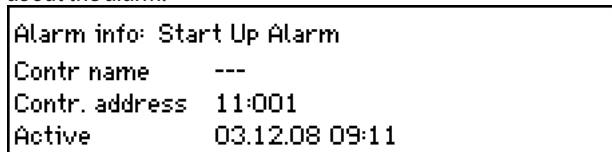

When the alarm disappears:

- The alarm symbol in the overview display disappears
- A "cancelled alarm" is sent to alarm destinations (only IP, SMS and modem connections).

If you want to see the Alarm history, you need to press the alarm button and then the "right arrow" button

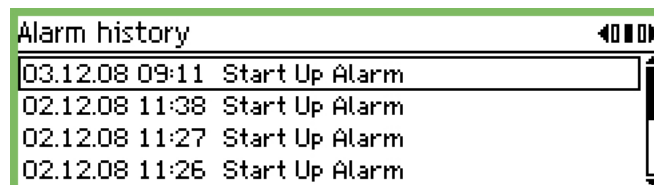

The Alarm history can store up to 200 alarms. Once it reaches 200 the new alarms will overwrite the oldest ones.

If you want to see the Event log you need to press the alarm button and then press the "right arrow" twice

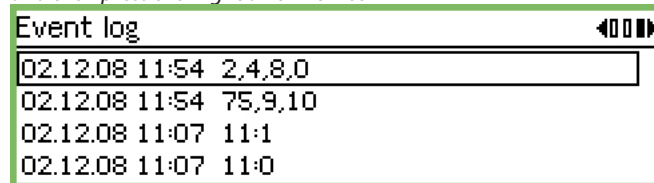

When you press the alarm button **again**:

- All the alarms are acknowledged (confirmation that they have been seen)
 - The built-in siren stops
 - If a relay to the alarm function has been defined, it will return to the state "no alarm" (relay configuration page 41).
 - The LED by the alarm button stops flashing and changes over to being lit constantly if the error is still there. It will go out if the error has disappeared.
 - The alarm text is transferred to the "Alarm history" list
 - **Active alarms will continue** to be shown in the display.
- (This second press (acknowledgement) can be blocked with a password.)

Data

AK-SM 350

Supply	115 V / 230 V +10/-15%, 50/60 Hz, 10 VA	
Connection	PT 1000 ohm at 0°C or PTC 1000 ohm at 25°C or NTC 5000 ohm at 25°C or Termistor (-80 to 0, -40 to 40 or 0 to 100°C) Digital On/Off signal or Standard 0 - 10 V / 4 - 20 mA signal	
Pulse counter inputs for output reading	Acc. to DIN 43864. (Only for inputs 1 and 2)	
Display	Graphic LCD, 240 x 64	
Direct measuring points	16	
Total number of points	65	
Measuring range, general	-100 to +150°C	
Measuring accuracy at Pt 1000	Resolution 0.1 K Accuracy: +/- 0.5 K	
Measuring interval	15, 30, 60, 120 or 240 minutes	
Data capacity	12 MB flash Recording of all data from all measuring points for one year at 30-minute intervals. Last 200 alarm warnings	
Battery backup	Button cell for clock function (2032)	
Power supply for e.g. pressure transmitter	5 V max. 50 mA 12 V max. 50 mA	
Printer connection	HP PCL-3, Parallel	
Modem connection	RJ 45	
TCP/IP connection	RJ 45	
PC connection	RJ 45 (RS 323)	
Data communication	RS232, RS485 (LON), RS485 (MOD- bus), RS485 (TP) (TP= Third Party)	
Relays	Quantity	2
	Max. load	24 V a.c. or 230 V a.c. I _{max} (AC-1) = 5 A I _{max} (AC-15) = 3 A
Enclosure	IP 20	
Ambient environment	0 to 50°C, during operation -20 to +70°C, during transport 20-80% RH, Non-condensed No shock loads/vibrations	
Approvals	EN 60730-1 and EN 60730-2-9 EN 61000-6-3 and EN 61000-6-2 EN 12830 and EN 13485	
Weight	1.6 Kg	

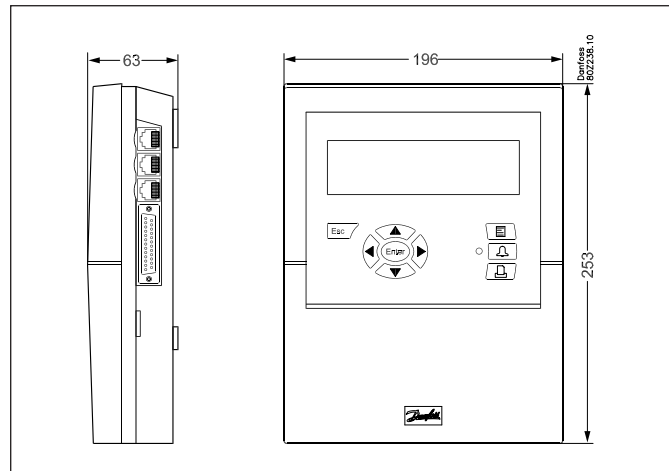

Capacitive load

The relays cannot be used for the direct connection of capacitive loads such as LEDs and on/off control of EC motors.

All loads with a switch mode power supply must be connected with a suitable contactor or similar.

Ordering

Type	Measuring points	Description	Language	Code no.
AK-SM 350	16	With inputs for PT 1000 ohm, PTC 1000 ohm , NTC 5000 ohm	English, German, French, Dutch, Italian	080Z8500
			English (UK), Spanish, Portuguese, English (US)	080Z8502
			English, Polish, Czech	080Z8504
Cable for PC (see also AK-ST 500 literature)		RJ 45 - Com port		080Z0262
Modem cable				080Z0261

Installation

Assembly

Opening

1. Release one of the two snap catches on the side of the unit.
2. Pull off the cover.

Closing

Push the cover into place so that the two snap catches click shut.

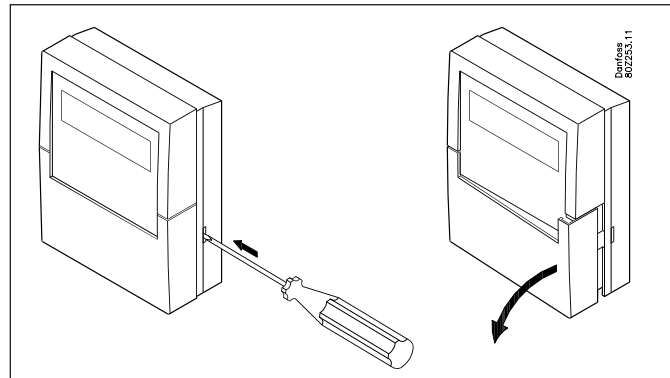

Position

The unit should be positioned as follows:

- At eye level
- Not in direct sunlight
- Nowhere strong light can cause reflections on the display
- Not in extreme temperatures or anywhere damp
- Not close to sources of electrical interference

The unit is secured with 3 screws.

The top one is positioned at eye level. Make sure that the head of the screw is not sticking out so much that it is touching the PCB. Then hook the unit on the screw and fit the two remaining screws.

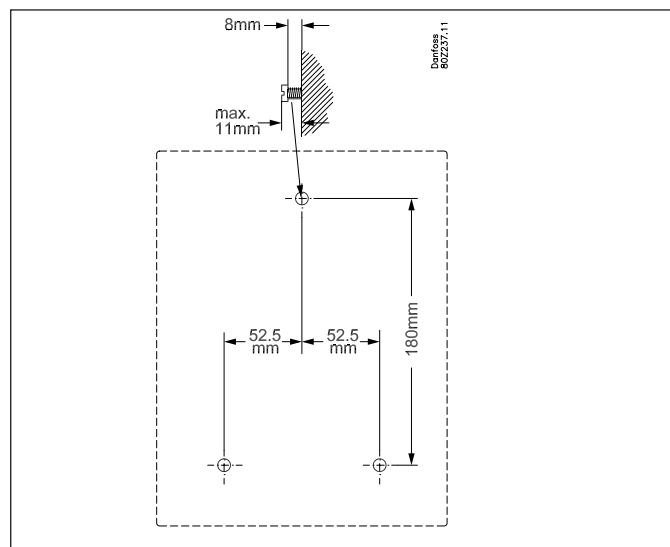

Connections

Principle

Up to 16 direct readings can be connected to the AK-SM 350. If the number of direct measuring points is not sufficient, readings can be retrieved from an AK-LM 330. The readings are retrieved via the RS485 - LON data communication. Readings from a gas detector are also retrieved from this data communication.

If separate refrigeration controllers (type EKC or AK) are used, temperature readings can be retrieved from these controllers. The readings are retrieved via the RS485 - LON or MOD-bus data communication.

Controllers type AKC (DANBUSS data communication) can be connected via AK-PI 200 connected to the TCP/IP input.

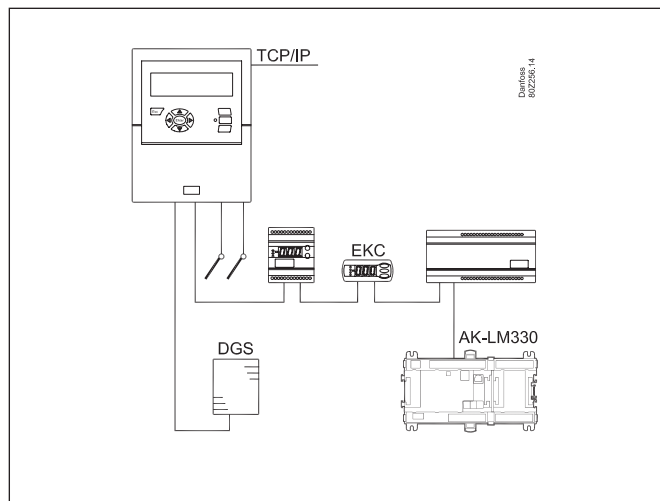

Connections overview

The supply voltage is connected on the left-hand side. Next to this connection are two relays which can, for example, be used for the modem reset, watchdog or alarm relay. For safety reasons both relays must be used at the same voltage – 24 V on one relay and 230 V on the other is **not** permitted.

On the right-hand side all the connections are low voltage. There are three types of data communication which can be connected to other Danfoss cooling controllers equipped for the same type of data communication. Then there is a 5 V and a 12 V supply. They can be used for supply voltage to a pressure transmitter that is to provide a signal to one of the measuring points.

There are 16 connections on the far right-hand side. They can be linked up however you like to signals from sensors, switch functions and voltage signals of up to 10 V. However, if there are pulse readings, they must be linked up to nos. 1 or 2.

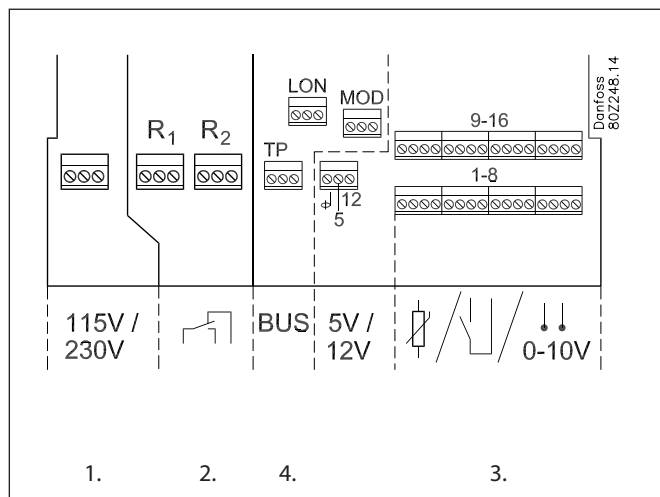

1. Supply voltage

The supply voltage must be 230 V AC or 115 V AC. At connection, the changeover switch must be set to the actual voltage.

The permitted tolerances mean that the supply of 115 V also includes supply voltages of 110 V and 120 V.

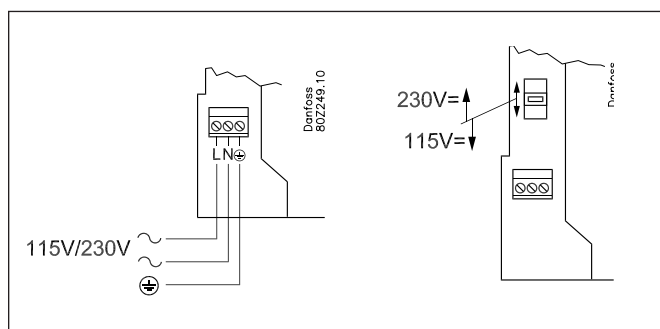

2. Relays

The two relays can be used for:

- External alarm function
When connected as shown, an alarm will be emitted in alarm situations and when the power to the AK-SM 350 disappears.
- Resetting the supply voltage for a modem
After a power outage, the AK-SM 350 will control the supply voltage for the modem, ensuring the modem restarts in a controlled manner.
- Watchdog
Here the relay is enabled in time intervals. For example, once an hour. If there is no relay change, an external unit will sound an alarm.

The two relays must be connected to either low or high voltage (115/230 V), but **not** low voltage on one and high voltage (115/230 V) on the other.

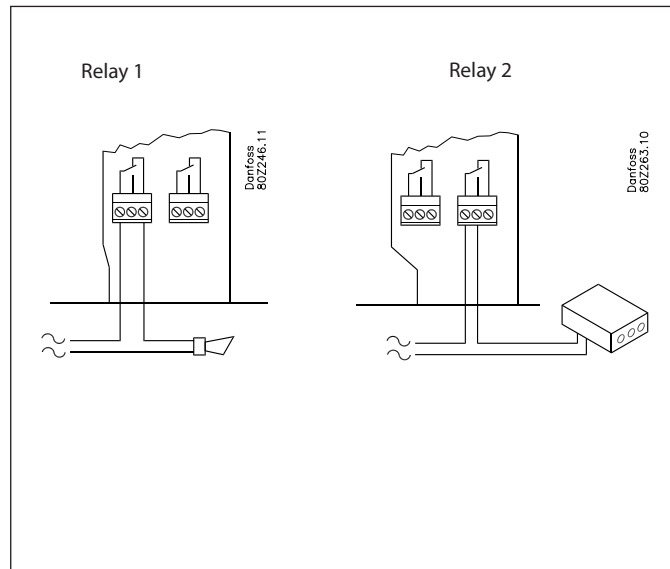

3. Direct measuring points

There are 16 direct measuring points.

All the odd numbers are signal inputs. All the even numbers are earth. All the even numbers on the PCB behind the terminal block are linked to a common earth.

If you use a common earth wire to several measuring points you should delimit it into groups. Do not put temperature signals, switch signals and voltage signals in the same group. Keep your distance from sources of electrical interference and power lines.

Sensor connections

One of the conductors is wired to an odd terminal block number. The other is wired to earth (even number).

On/off signals from a switch function

One of the conductors is wired to an odd terminal block number. The other is linked to earth (even number). The switch can either be a make contact or a circuit breaker. The function is defined under setup.

Output reading (pulse recording)

Only measuring points 1 and 2 can be used for output readings. These inputs are designed for fast on/off changes. Pulses are measured in accordance with DIN 43864. The signal is wired as an on/off signal.

Voltage signal

The voltage can vary between 0 and 10 V DC. Minus is wired to earth (even number).

Current signal

The current signal can vary between 4 and 20 mA. Minus is wired to earth (even number).

Gas detector, type DGS

This gas detector can give a voltage signal or a current signal for AK-SM 350.

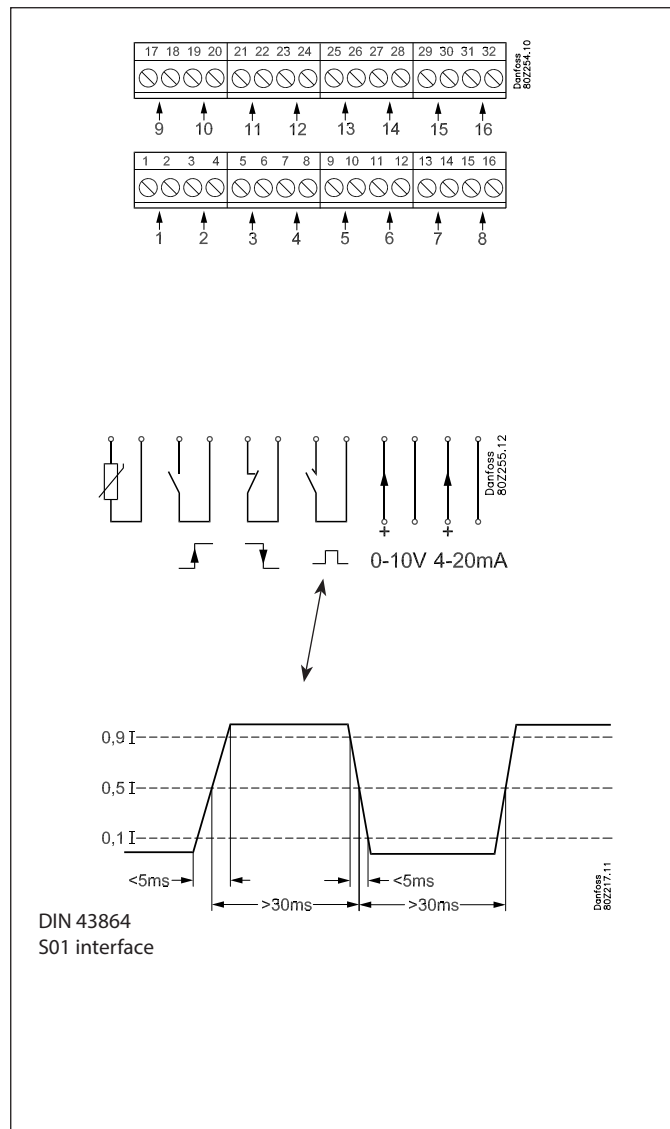

4. Data communication

If readings are to be retrieved via data communication, this must be done as follows:

Controllers

The AK-SM 350 can receive signals from a number of controllers. The controllers are connected to the RS485-LON communication or RS485-MOD-bus communication. These two types cannot be mixed.

Cable

There are no requirements concerning the positioning of the AK-SM 350 for data communication. It can be at one end of the cable or it can be anywhere along the cable.

Wiring

• LON-bus

There are no requirements concerning the polarisation of the A and B connections. The screen connection must be looped onwards for each controller.

• MOD-bus

A⁺ must be wired to A⁺.

B⁻ must be wired to B⁻.

The screen connection must be fed onwards and fitted into all controllers.

Termination

Each **end** of the data communication cable must be terminated with a resistance of 120 Ω. In some EKC controllers a termination jumper is fitted. Termination takes place here by closing the jumper.

Addressing

Every controller must have an address set. This address will then be recognised by the AK-SM 350.

*BUT this is provided that the address has not already been defined for the other side (another controller on the same or different data communication). If it has already been used, the existing setting will be kept and the last one entered will **not** be used. Nor should you use an address taken by a gas detector. **Duplicated addresses are not permitted.***

- Each EKC controller must have "003" entered with every address.
- The AK-SM 350 is then able to receive these addresses. There are two possible ways for this to happen:
 - Either by activating "004" in every EKC controller, but this will require a voltage on the AK-SM 350. (Controllers with MOD-bus communication do not have an "004".)
 - Or by enabling the "scan function" in the AK-SM 350. This requires all the EKC controllers to have an address set. A controller with MOD-bus communication can only be found via this scan function.

In the later setup, we want to activate the "scan function", after which all addresses can be viewed in the network list.

Gas detector, type GD

If a type GD gas detector is used, it must be connected to the "TP" data communication.

For assembly and connection, please see literature sheet RD7HA.

Set the address in the gas detector (max. no. of addresses is 65).

An address used by an EKC controller must not be duplicated.

Make a note of the address. It will be used later on, when the AK-SM 350 has to be set up.

The actual installation of the data communication cable must comply with the requirements mentioned in the document "Data communication between ADAP-KOOL® Refrigeration controls". Literature sheet number = RC8AC.

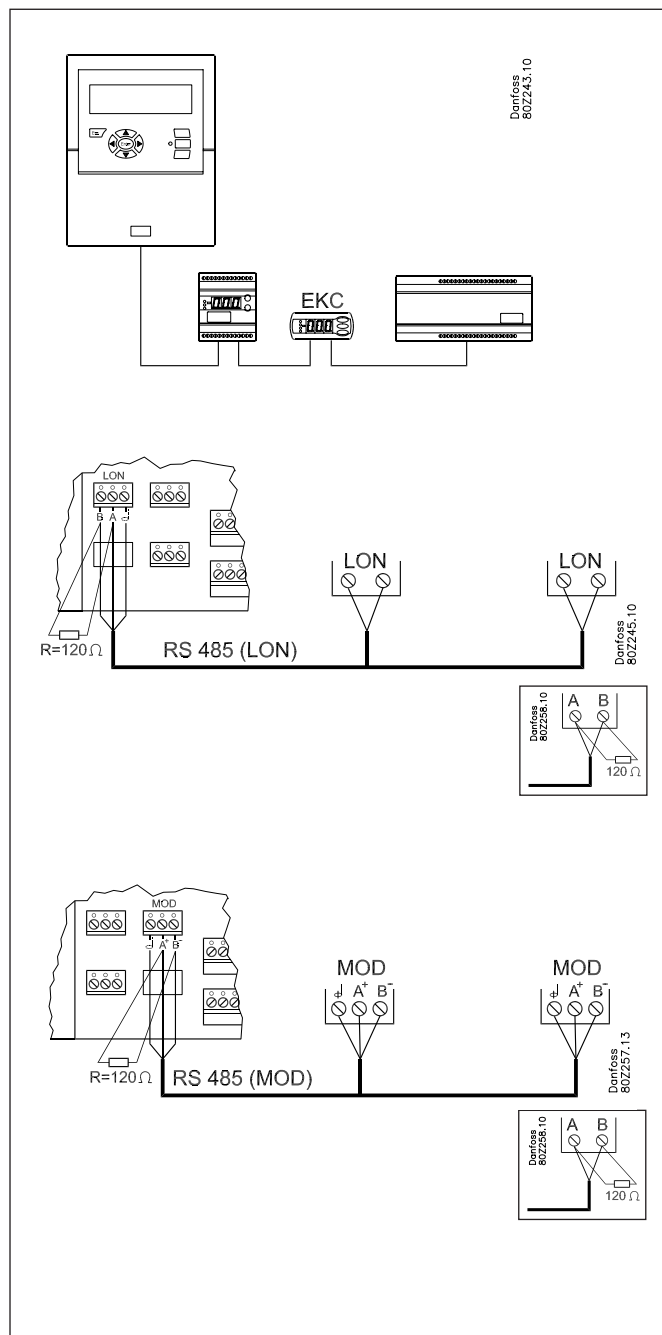

External communication

At the side of the unit there are connectors for external communication.

They can be used for the following:

- Setting up the unit
- Receiving alarms at a service company
- Receiving alarms on a mobile phone
- Service
- Printer connection. Printing out logs and alarms

PC connection

This connection can be used when setting up the unit or when carrying out service.

The PC must have the AK service tool program uploaded.

If text for individual points needs to be entered, it would be a good idea to use a PC connection.

If several units are to be installed with the same setup, it would be very helpful to use the copy function in the AK service tool.

If logs are to be retrieved from the unit, this can also be done in this way.

See also the literature sheet for the AK service tool.

TCP/IP connection

Here the unit can be linked to an Ethernet or a unit can be connected for setup and service.

Modem connection

Here a modem can be connected to a fixed network or mobile network.

Printer connection

The printer can be connected when there is a need for print-outs of e.g. logs, alarms or curves of a temperature sequence.

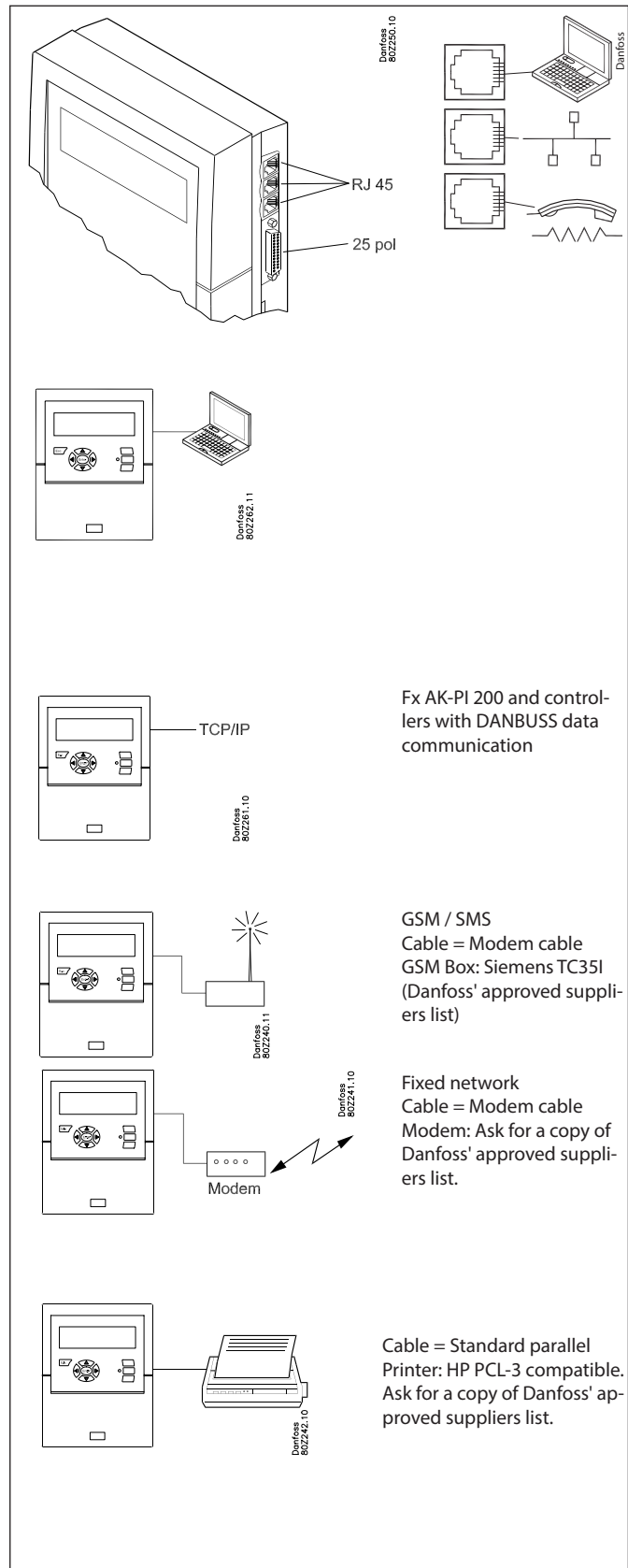

Configuration

Principle

This page describes the setups that are to be installed in the monitoring unit. The points are detailed briefly so that the list can be used as a checklist. The monitoring unit is set up once each point has been reviewed.

If you require help setting up individual points, you will find a more detailed explanation in the next section – The functions' mode of operation.

Procedure

1. Create an overview of all the connections.
Decide where they will be connected.
Decide the alarm priority for the reading.
The table below shows some examples of the various possibilities.

Point no. in display	Name	Type of connection							Place of connection		Priority of alarm				Note
		Temperature	Di (on/off)	Ai (analog)	Power meter	Power meter log	Gas-detector	Controller	Terminal	Address	High	Medium	Low	Log only	
1	xxxx A	x							1-16		x				
2	xxxx B		x						1-16			x			
3	xxxx C			x					1-16					x	
4	xxxx D				x				1-2					x	1 or 2 only
5	xxxx E							x		1-65	x				
6	xxxx F							x		1-xxx	x				
7	xxxx G					x									Load/store data from Power meter

Then continue by:

2. Pressing the button for the main menu
3. Selecting "Service Setup" at the bottom of the display
4. Go through all the functions in "Basic setup". In one of the functions, the network will be scanned, which allows the monitoring unit to recognise all the connected units on the data communication. Do not forget that the controllers must have an address set, or to check that the power is turned on **before** the scan function is enabled.
5. Select Point setup
6. Set all points. Use data from a table like the one above. Some of the readings will have two alarm limits. Different alarm priorities can be set for each one.
7. Create a table of the alarm activities. See the table on the right.
8. Set up the alarm function
 - a. Set the general functions first
 - b. Then set how an alarm should be handled/routed (i.e. what will be enabled)
 - c. And finally, set up the activities chosen (e.g. addresses of the alarm destinations)
9. Check that the alarms can be sent properly
 - a. Set the function "Test alarm priority" to "high"
 - b. Enable the function "Test alarm"
 - c. Check that the alarm is received
 - d. Repeat this check for the other alarm priorities
 - e. Repeat this check until all the destinations have been tested to see if they can receive alarms.

Table of alarm activities (example)
(Referred to in point 7 and utilised in point 8b)

Route 1

Time	Alarm priority	Alarm activity			
		Remote no.	Relay	Buzzer	SMS
<i>Primary alarm destination</i>					
Day	High	1		x	
	Medium	1			
	Low	1			
Night	High	2			
	Medium	2			
	Low	-			
<i>Alternate destination (if the link to the primary destination fails)</i>					
Day	High				
	Medium				
	Low				
Night	High				
	Medium				
	Low				
<i>Copy destination</i>					
Day	High				
	Medium				
	Low				
Night	High				
	Medium				
	Low				

The functions' mode of operation

The display

This section will explain all the different functions in the different display screens.

When an arrow is shown in this position, you can move to the next or previous point (or display) by pressing the "right arrow" or "left arrow".

This is the overview display that shows all the defined readings. Here each point is represented by a symbol.

Point 1 is at the top left. 2 comes next and so on. A total of 65 points, and thus 65 readings, can be shown.

A reading can be a :

- Temperature reading
- Voltage signal or current signal
- On/off signal from e.g. a door switch
- Pulse signal from an output reading
- Signal indicating that a defrost cycle is in progress
- Signal from a gas detector
- Signal from a refrigeration controller. In this case the reading could be a temperature etc.

If you want to see the reading for point 3 for example, you need to press the "right arrow" or "left arrow" a number of times until point 3 is highlighted. Then you need to press "Enter" in order to see the next display.

Changing the light strength

Hold the ESC button down and press the up/down arrow.

Changing the contrast

Hold the ESC button down and press the left/right arrow.



In the overview display you can use the buttons to get to the different points, or the monitoring unit can be set up to "scroll" through the points. The view is reset once the last point has been shown.

The overview display

The readout always returns to the overview display if it is inactive for two minutes.

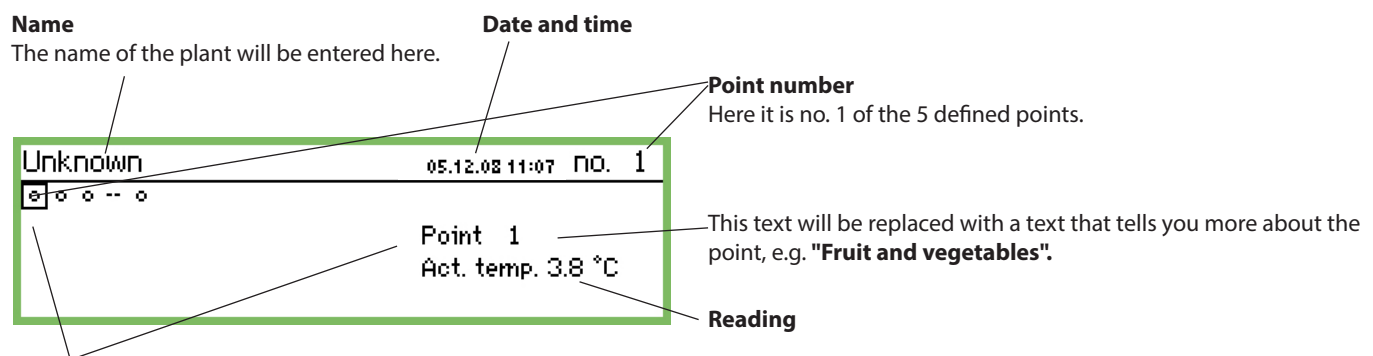

Symbol for each point

When a point is marked with a square, the text and reading for this point will be shown at the right of the display.

A symbol for the point is shown inside the square.

The symbol could be one of the following:

- Circle = Point
- ☼ Drops = Defrost
- 🚨 Alarm
- 🚫 The alarm has been suppressed (via the "More details" screen)
- 🔌 Connector = No link to controller
- Dashes = Configuration error. See page 26 for information.

Scanning of all points

This function can be chosen as an option. The point's value is shown here for about 3 seconds. Then it moves on to the next point. When all the points have been scanned, the process starts again from the beginning.

Display screens for daily use

• Point detail display, showing the point's actual values

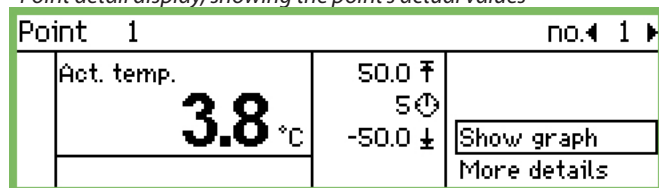

Name and point number

- Symbol illustrating the operating situation of the point
- Temperature values
- Value for the high temperature alarm
- The delay time for the alarm
- Value for the low temperature alarm
- Access to the graph screen etc.

• Graph display, showing the point's previous readings

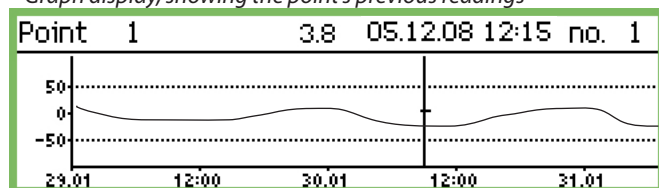

Temperature sequence for the point

If you want to examine the values from the graph more closely, press "Enter". A vertical line will then be shown on the graph. This line indicates the time of the graph.

The temperature value for this time is shown on the top line.

The vertical line can be moved using the arrow keys.

If you want to zoom in or out on a time, use the up/down arrow keys. These are indicated on the top line with an up arrow and down arrow.

The values in the "More details" screen can be changed from the monitoring unit. The new setting will be sent to the controller.

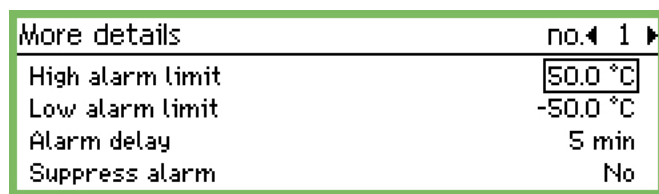

The values in "More details" are written to the controller if they are changed.

Main menu

The main menu comes up if you press the top right-hand button on the front panel.

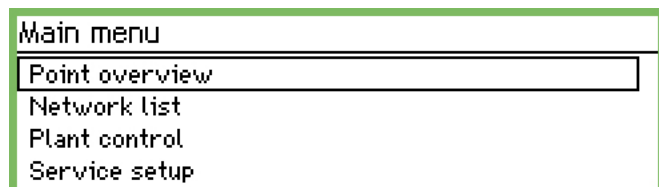

You can access the following four functions from this menu:

Point overview

From here you can go back to the overview display. Please see the previous page.

(The monitoring unit will automatically return to the overview display if the buttons are not activated for 2 minutes.)

Network list

The units that are connected via data communication are shown here.

The readout is only available during setup and service (e.g. in an alarm situation in which no signal is received from a controller).

Plant control

Here you will find the functions that are used in daily operation, i.e.

- Defrost and lighting schedules
- Defrost setups
- P0-optimization

This screen is described overleaf.

Service setup

This is where the basic setups for the individual points and functions are carried out.

This screen is described from page 21 onwards.

Functions for daily use – Setups/adjustments

This is where you set the functions used for daily operation.

• **Time schedule for specifying the store's opening time**

This schedule is for sending a signal to selected controllers in order to tell them that the temperature needs to be adjusted because covers have been placed over the refrigeration applications.

The schedule is also used to route alarms. However, this is only if different alarm destinations have been defined for the day period and the night period.

• **Time schedule for specifying defrost points**

The schedule is used to send signals to selected controllers telling them to start a defrost cycle.

To the end user

These functions are an option, but they are only applicable if controllers have been installed that can receive the signals in question.

To the installer

Please put a cross in the box if the functions have been installed in such a way that they can be operated from the monitoring unit.

- Yes
- No

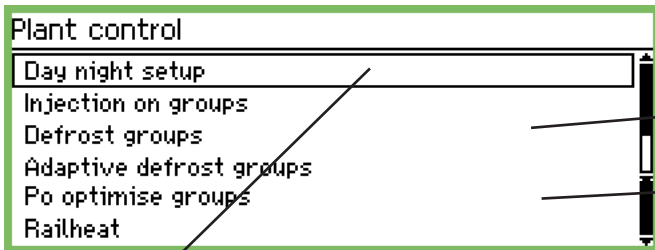

Defrosts, see 2 pages further

P0 optimisation, see 3 pages further

Day / night setup

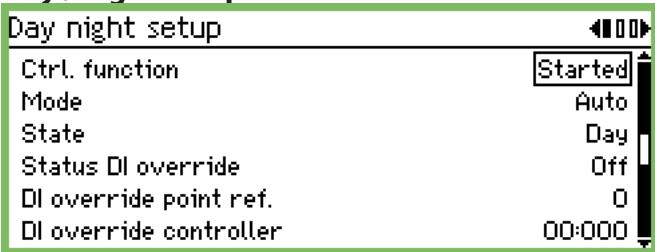

DI override from a Reference point (see "Mode" = auto)

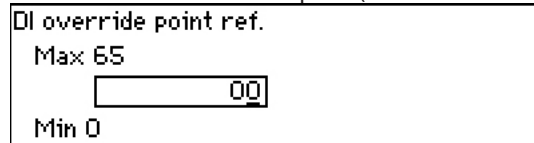

The point which the override signal is to follow is selected here. If the point is On, the signal status "Day" will be sent to the EKC's.

Control:

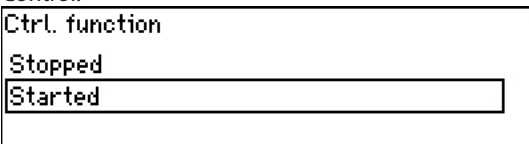

If "Started" the signal status will be sent to the EKC's.

Mode:

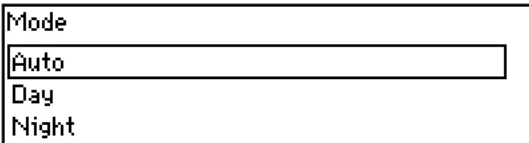

- If "Auto" is selected, day and night will change automatically. The signal follows the on/off value on the reference point. See next setting.
- If "Day" is selected, the controller will always be in daytime operation.
- If "Night" is selected, the controller will always be in night-time operation.

State:

This display shows whether the controller is in Day or Night mode.

Status DI override:

This display shows the status of the override signal, which is received from one of the two following settings.

DI override from a controller parameter

The address and parameter can be set via service tool type AK-ST 500. This is performed as follows:

1. Connect the AK-ST 500 to the monitoring unit
2. When the network overview is shown, press the plant control button
3. Select day/night group
4. Select the location from which the signal will come:
 - a. Press 'New'
 - b. Select controller address (e.g. 001:005)
 - c. Select the group from which the signal will come
 - d. Select which parameter will send the signal

Time schedule

(The schedule is found "one arrow to the right" of "Day/night setup")

Store schedule	
Monday on	08:00
Monday off	18:00
Tuesday on	08:00
Tuesday off	18:00

This is where you set the store's opening and closing times. The times can be used for alarm routing and day/night signals to the controllers.

Monday on	08:00
-----------	-------

The hour setting and minute setting is entered using the arrow keys.

Day/night signal controllers

(The schedule is found "one arrow to the right" of "Store schedule")

Day night controllers	
Controller	00:000

This is where you set the addresses for all the controllers that are to receive day/night signals

Controller	Max 11:999	00:000
	Min 00:000	

Set address.
(00:000 means no address).

Inject ON signal

Injection on groups	
InjectionOn-1	
InjectionOn-2	
InjectionOn-3	
InjectionOn-4	

Configuration Inject. on 1	
Name	InjectionOn-1
Ctrl. function	Stopped
Manual mode	Auto
Injection	Off
Pack controller	00:000
Pack. section number	A

Name

Enter the name of the group here.

Ctrl. function

Here the user can see if the compressor regulation is in operation or stopped.

Manual

Here the Injection On regulation can be overridden

Injection

Here the status of the Injection On function is shown

Pack controller

The address of the controller regulating the compressors is set here.

Pack section number

If the controller can control more than one compressor group, the current group must be set.

Press 'right arrow' to define the controllers that will receive the signal.

Controllers Inject. on 1	
Add controller	00:000

Set the controller's address and press 'Enter'.

Controllers Inject. on 1	
Controller	03:004
Add controller	00:000

Continue with the addresses of the other controllers.

Starting defrosts

This is where you select a group of controllers which are to have a defrost signal.

There are two ways in which the controllers can be grouped:

1. Individually. Once the defrost has started, each controller will carry out the defrost and then restart refrigeration as soon as possible afterwards.
2. Coordinated. In this case, refrigeration will not resume until the whole group has finished defrosting.

It is possible to create 10 defrost groups, with each group containing a max. of 30 controllers.

The way to access the groups is shown on the previous page.

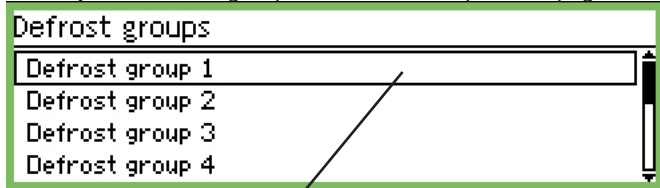

Group 1

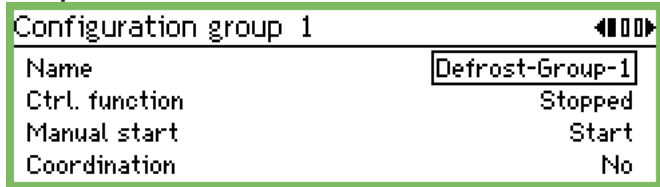

Name

Enter the name of the group here.

Defrost function

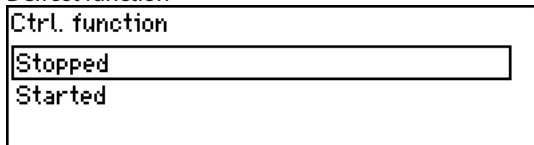

By using the setting "Started" the function is active. The schedule determines when the signal is to be sent to the individual controllers.

Starting a defrost manually

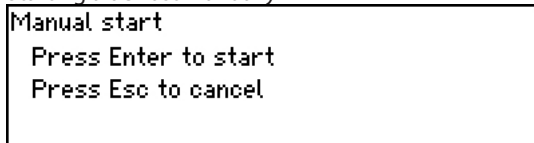

By pressing "Enter" you start a defrost in all the controllers in the group.

Coordination

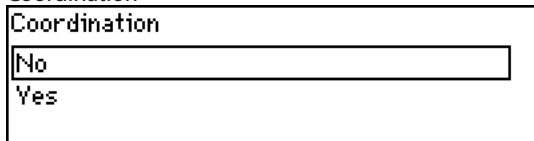

Select "Yes" if the whole group can only start cooling once the last controller has completed a defrost cycle.

(The group of controllers must support the function.)

Defrost schedule

(You will find the setting "one arrow to the right" of the group.)

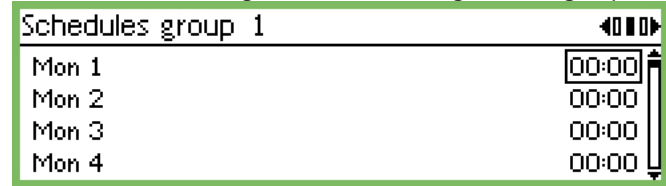

Up to 8 defrosts per day can be started.



A defrost time point is defined by setting a time. The time point 00.00 will not start a defrost.

Controllers group

This is where you define which controllers are to be in the group. (You will find the setting "one arrow to the right" of the schedule.)

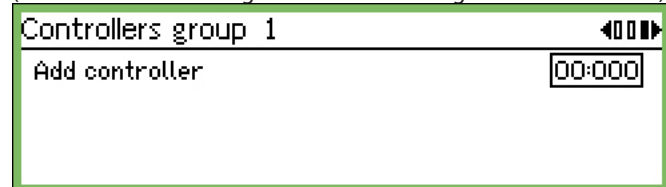

(There can be up to 30 controllers in a group.)

Controller address

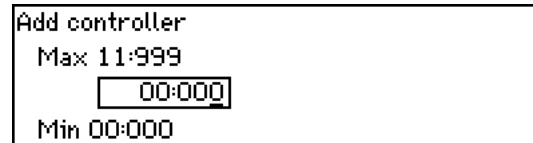

State the address of the controller that is to be part of the group. Once the address has been set, you will automatically be able to enter one more.

Group 2.

If there is a second or third group, or more, settings must also be entered for these.

Adaptiv Defrost

Other defrost groups can be created in which the controllers have an adaptive defrost function. The controllers receive signals for the current condensing temperature from the condensation control. Only controllers with the adaptive function can be selected for the group.

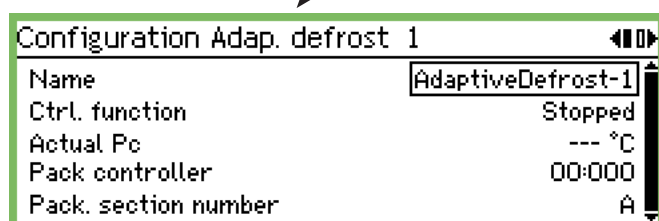
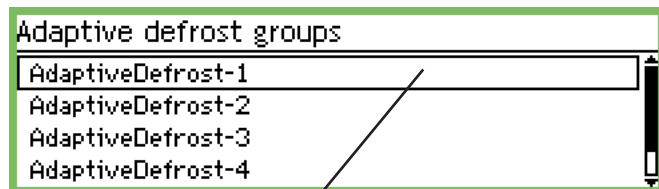

Name

Enter the name of the group here.

Ctrl. function

This display shows whether the defrosting is in operation or has been stopped.

Actual P0

The condensing temperature received from the compressor control can be read here.

Pack controller

The address of the controller regulating the compressors is set here.

Pack section number

If the controller can control more than one compressor group, the current group must be set.

Press 'right arrow' to define the controllers that will receive the signal.

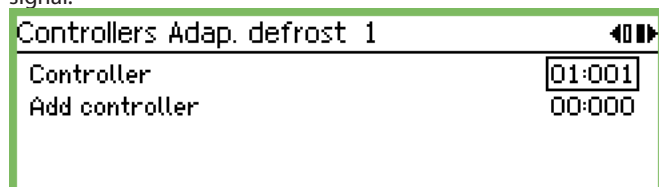

Set the controller's address and press 'Enter'.

Continue with the addresses of the other controllers.

P0 optimisation

Here you are able to select a group of controllers from which AK-SM 350 will be receiving signals. The received signals are processed and then a signal is sent to the pack control which adjusts the operation of the compressor so that it works optimally.

Max. 120 refrigeration sections can be selected in one group. A section that has just completed a defrost will not be included in this function. Data will only be collected again from the controller after 30 minutes. The time can be adjusted.

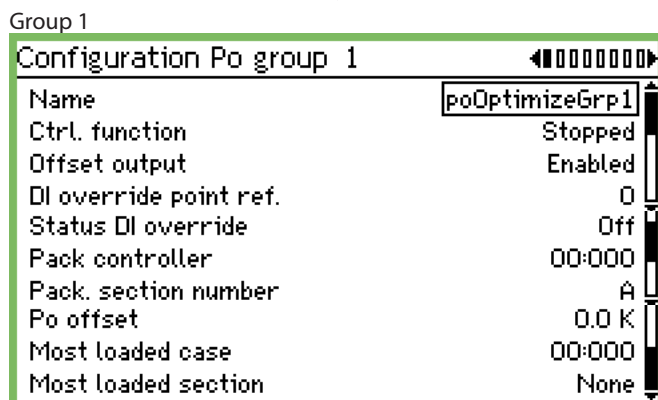
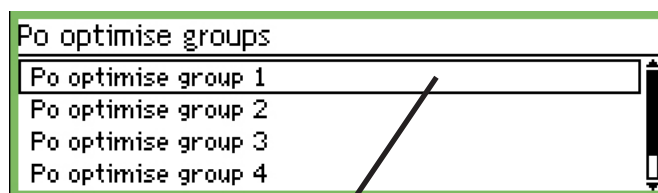

Name

Enter the name of the group here.

Starting and stopping the function

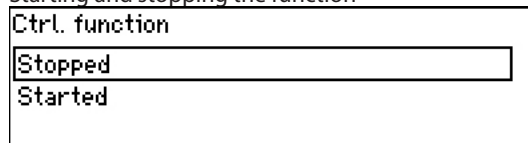

The P0 optimisation can be started and stopped here.

Offset

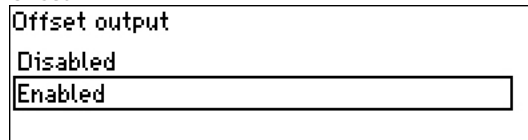

Here you allow the suction pressure to be offset.

Overriding the function

If you need to interrupt the P0 optimisation for a period during regulating, this can be done with a contact function on an input.

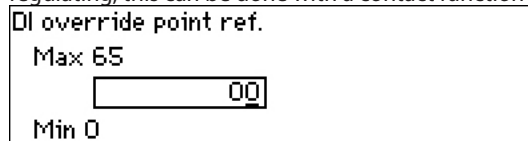

Set the point number that follows the switch signal.

Pack control

Set the address belonging to the group of controllers on the pack control.

Pack section number

If the controller can control more than one compressor group, the current group must be set.

P0 offset

The P0 displacement can be read here.

Most loaded case

This displays the address of the appliance bearing the greatest load.

Most loaded section

This shows which section of the appliance is bearing the greatest load.

Advanced settings

The setting can be found by pressing the right arrow once.

Avoid making changes – the settings should only be carried out by trained personnel.

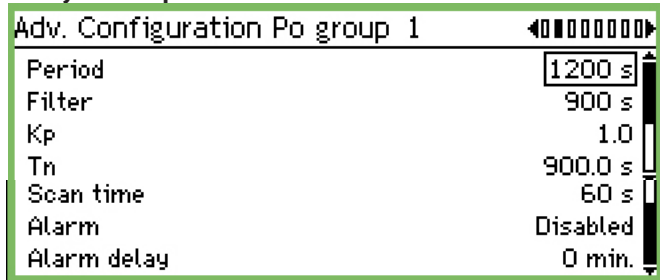

Time period

Define how often data are to be collected from the different controllers and the 'section with the highest load'.

Filter, Kp, Tn, S

Regulating parameters

Scan time

How often data is collected from the 'section with the highest load'.

Alarm and Alarm delay

A function that can trigger an alarm if the optimisation function displaces (lowers) the suction pressure down to 90% of the pack control's minimal P0 setting.

Selecting controllers for the group

The setting can be found by pressing the right arrow once.

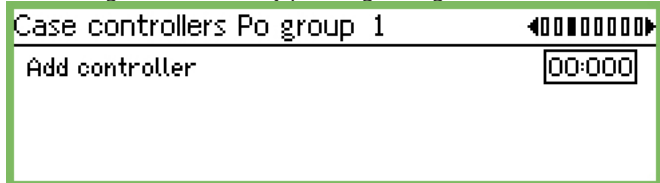

Set the address of a controller to be included in the group.

Set the section.

Continue to the next controller address, etc.

Adaptive Railheat

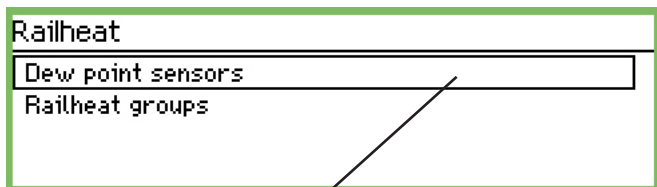

Sensor 1

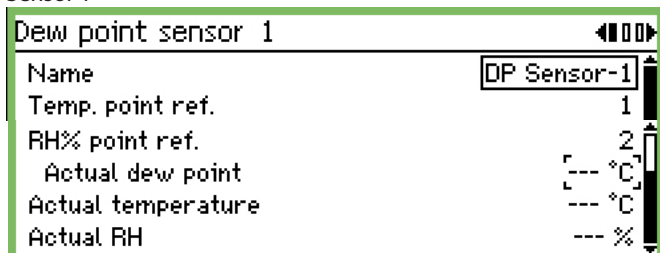

Name

Enter the name of the sensor.

Temperature reading reference

Set the point established to register the temperature.

Moisture reference

Set the point established to register the moisture.

The point must also be set to analogue input and the signal to e.g. 0-10 V. The moisture sensor must be set to deliver the same signal type.

Reading

In the next three lines you can read the actual values for 'calculated dew point', 'measured temperature' and 'measured relative humidity'.

Press the 'right arrow' if there are several groups and thereby several sensors that must be set.

Groups

Define the controllers that are to be included in the group.

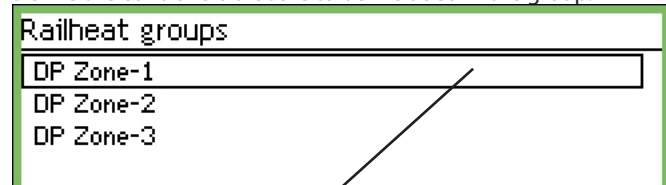

Group 1

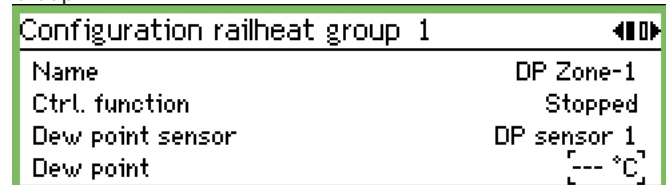

Name

Enter the name of the group

Ctrl. function

The function is started and stopped here.

Dew point sensor

Select one of the defined sensors here.

Dew point

The actual dew point can be read here. The address is sent to the respective controllers.

Press the 'right arrow' to define which controllers will receive the signal and initiate the rail heating function.

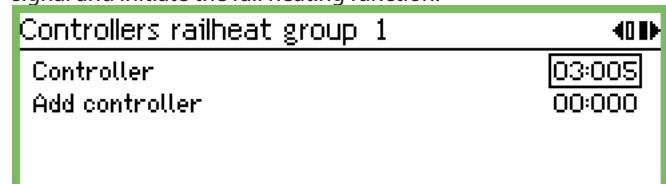

Set the controller's address and press 'Enter'.

Continue with the addresses of the other controllers.

Configuration settings

- The first three pages contain the basic settings.
- Then there are seven pages containing settings for measuring points.
- After this come alarm settings and print setups.

Basic setup

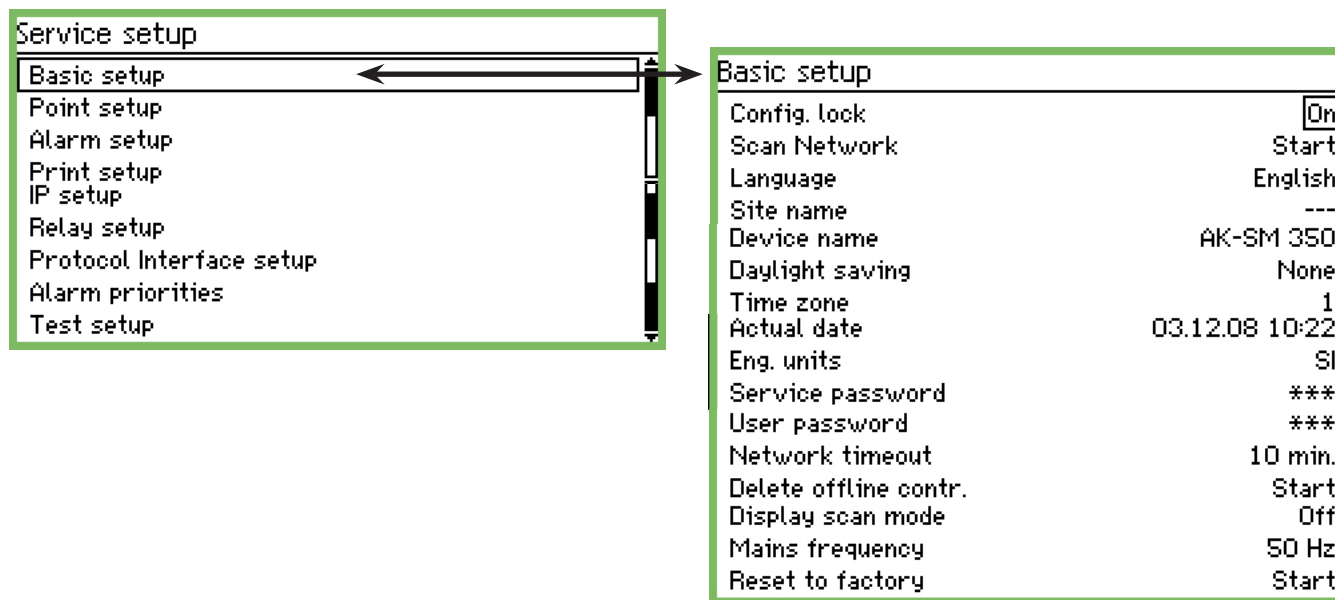

The basic settings are as follows:

Configuration lock

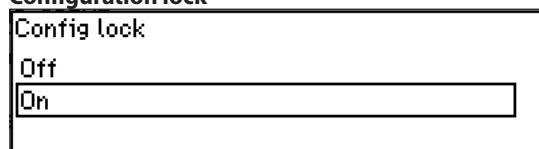

This is where the configuration is locked once all the settings are in place. Setups can only be performed when the setting is "Off".

Language

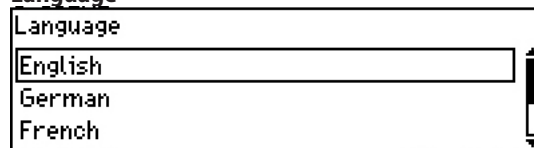

This is where you select the language used in the monitoring unit.

Scan network

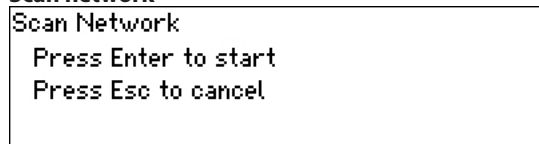

This function is used when installing controllers. All EKC controllers and gas detectors **must** be connected to the appropriate data communications before the function is activated. When the function is started, the monitoring unit will scan the data communication and register which controllers are at which addresses. The results can be viewed in the network list.

Name

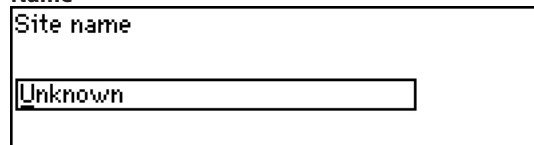

The name of the store is entered here. The name is used in external communication and can be seen at the external operating interface. Use the four arrow keys to enter the name.

Device name

Device name

AK-SM 350

The factory enters the type designation in this position. The name can be changed as required. Use the four arrow keys to change the text.

Daylight saving

Daylight saving

None

EU

US

This is where you set whether the monitoring unit's clock function is to switch to summer/winter time at the appropriate date and time.

If a change to summer/winter time is required, you must select the relevant European or US times.

The monitoring unit will change time itself when the day arrives to put the clocks forward/back.

Time zone

Time zone

Max 12

01

Min -12

0 is UK (GMT) time.

1 represents the time zone Germany, France, Spain, Italy, etc.

Date and time

Actual date

03.12.08 10:39

This is where you set the date and time.

A battery in the monitoring unit will maintain the clock function in the event of a power failure. The battery will normally last for several years and an alarm will be generated when the battery is due to be replaced.

Names of measuring units

Eng. units

SI

US

Danfoss SI

This is where you set which units the various readings will be shown in:

SI: Bar and Kelvin K, (°C)

US: Psi and °F

Danfoss SI: Bar and °C (pt is no different to the SI setting).

Service password

Service password

A password can be entered if you need to limit access to the important settings. Once access has been achieved with this password, it will be possible to carry out service and install new setups.

Password for daily access

User password

A password can be entered if you need to limit access to the daily settings. Once access has been achieved with this password, it will be possible to make settings.

Access without using a password

If a password is used for daily use and/or for service, access without the use of codes will be limited to read-only parameters.

Timeout of network

Network timeout

Max 240 min

010 min

Min 1 min

If the monitoring unit cannot contact a controller on the network, it will try again. This will happen repeatedly, and if it does not succeed in contacting the controller within the set time, an alarm will be generated.

Delete a controller from the network

Delete offline contr.

Press Enter to start

Press Esc to cancel

This function must be used if a controller is deleted from the data communication. The function updates the network list so that "of-line controllers" are deleted from the network list.

Readout of the point in the overview display

Display scan mode
Off
On

This function only applies to the readout in the overview display. With the setting = On, a point will be shown for a few seconds, after which the display moves on to the next point. When all points have been displayed, the readout starts again from the beginning. With the setting = Off, the point required will be displayed continuously in the overview display.

Mains frequency

Mains frequency
50 Hz
60 Hz

This is where you set the frequency for the supply voltage.

Reset to factory

Reset to factory
Press Enter to start
Press Esc to cancel

This function must be used if you want to reset to factory settings.

Setup of points

The next 9 pages contain settings for measuring points. The first three pages cover the settings for a temperature reading. If the reading is not a temperature reading, the settings can be viewed on the following 6 pages.

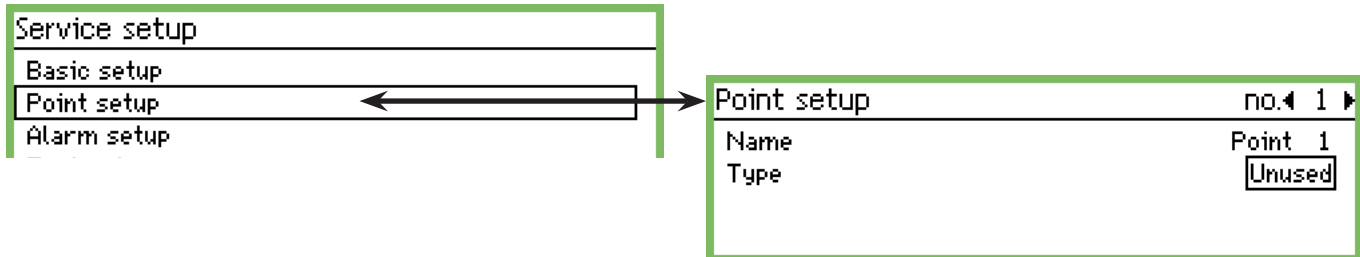

1. Select a point

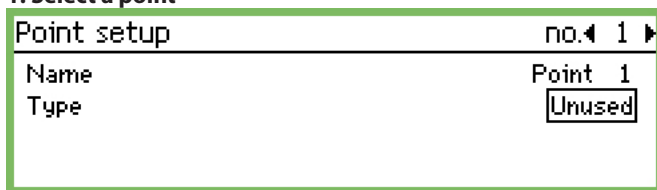

A point which is highlighted is shown on the top line. Here it is number 1. If you would like another number, scroll up or down using the "left arrow" or "right arrow". Stop at the number you require.

2. Name

The name of the start text will always be "Point no.". Press "Enter" to edit the text

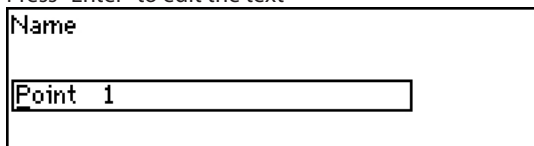

Enter the name of the reading.

3. Type

This is where you define the type of reading received for the point. When the definition has been entered, further settings for the reading are enabled. Here, "Temperature" has been selected.

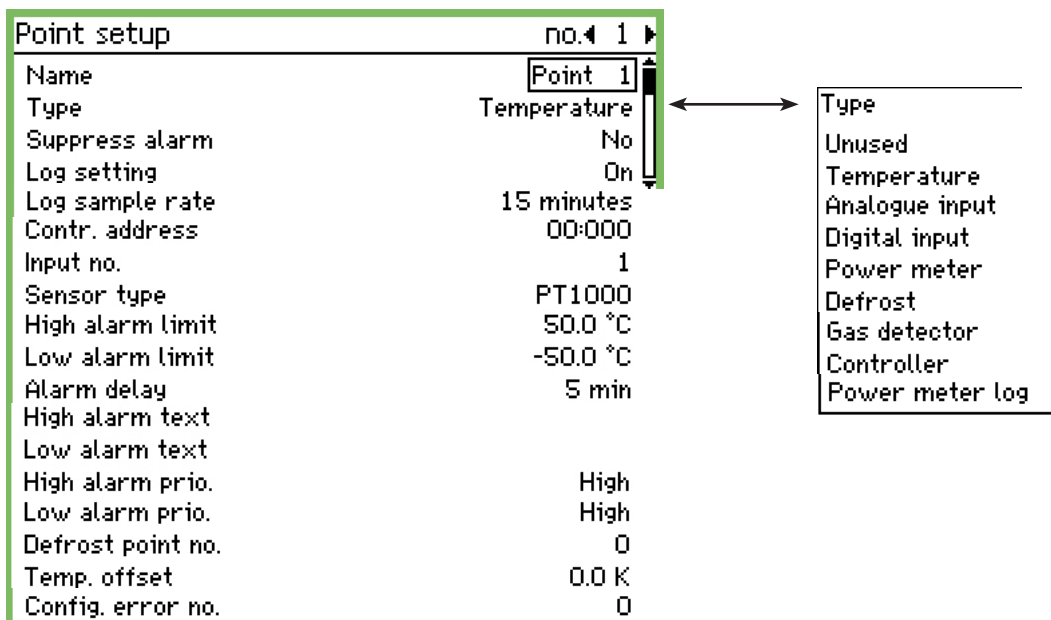

This screenshot shows the various type options

Settings if you choose temperature are shown on the next two pages. Settings for the other types can be found immediately afterwards. (Some of the settings are the same, regardless of type.)

4. Alarm from point (also for service)

Suppress alarm

No

Yes

With this setting the alarm from a point can be suppressed. The default setting will be "No" – which means that alarms are received from the point. Select the "Yes" setting if an irritating alarm needs to be stopped during servicing. After 12 hours, the setting will automatically return to "No".

5. Log

Log setting

Off

On

Selected for print

This is where you define whether the point's readings should be saved. Off: No collection On: This is where the actual value for each interval is saved. (The interval times can be: "15", "30", "60", "120" or "240" minutes. The times are fixed and cannot be changed.) "Selected for print": This is where the actual values are saved so that they can also be printed out. If not all 65 points are set up with log collection a number of different service logs can be defined. The capacity determines how many. Follow the remaining capacity when the setup is done from the "Service tool".

6. Log sample rate

Log sample rate

15 minutes

30 minutes

1 hour

This is where you set how often the measured value is to be saved. **A reading is stored for one year. It is overwritten once a year has passed.** Choose between 15 mins., 30 mins., 1 hour, 2 hours or 24 hours. Examples of the capacity: approx. 57 measuring points @ 15 mins. corresponds to one year. approx. 50 measuring points @ 15 mins. + 15 measuring points @ 30 mins. correspond to one year. Fewer measuring points and/or longer interval times will not create problems, but if you exceed the guidelines and thus the capacity, you will get a configuration error. See overleaf.

7. The measuring point's address on the data communication

Contr. address

Max 11:999

00:000

Min 00:000

There should only be one setting here if the reading is produced with one of the three data communications: LON, MOD or TP. E.g. from an EKC controller or a gas unit.

Set the address. The setting 00:000 is a reading connected directly to the AK-SM 350 unit. All other settings mean that the reading is retrieved from the address given in the setting. (When an address is set, the digit "00:" is automatically set to "01" or "11". This setting cannot be changed.)

8. Input no.

Input no.

Max 16

01

Min 1

Should only be set if the reading is directly connected to the monitoring unit's terminals. This is where you specify which set of terminals is to be used. *The following settings only apply if "Temperature" was selected in point 3.*

9. Type = TEMPERATURE

Only with sensors that are directly connected to the monitoring.

Sensor type

- PT1000
- PTC
- NTC
- PT1
- PT2
- PT3

The sensors can be:
Pt, 1000 ohm at 0°C
PTC, 1000 ohm at 25°C
NTC, 5000 ohm at 25°C
PT1: Thermistor -80 at 0°C
PT2: Thermistor -40 at 40°C
PT3: Thermistor 0 at 100°C

10. Alarm limit for too high temperature

High alarm limit

Max 99999.0 °C

00050.0 °C

Min -100.0 °C

Set the temperature value at which the alarm will occur. (The setting will also be used for scaling the graph display.)

11: Alarm limit for too low temperature

Low alarm limit

Max 99999.0 °C

-00050.0 °C

Min -100.0 °C

Set the temperature value at which the alarm will occur. (The setting will also be used for scaling the graph display.)

12. The delay time for the alarm

Alarm delay

Max 360 min

005 min

Min 0 min

The alarm will not occur until the temperature value has been exceeded for the number of minutes specified. Set the number of minutes required.

13. Text for the high temperature alarm

High alarm text

This is where you can enter the alarm text that is to follow a high temperature alarm from this reading. If you do not enter a text, a factory-set text will appear.

Fx "Max temp Point _".

14. Text for the low temperature alarm

Low alarm text

This is where you can enter the alarm text that is to follow a low temperature alarm from this reading. If you do not enter a text, a factory-set text will appear. Fx "Min temp Point _".

15. Priority of high temperature alarms

High alarm prio.

High

Medium

Low

Set the priority

The setting determines the sort/action which must be carried out when an alarm occurs.

- "High" is the top priority
- "Log only" is the lowest priority
- "Disabled" does not initiate any action

The relationships between the setting and action are as follows:

Setting	Log	Alarm relay			Network	AKM destination (priority)
		Non	High	Low - High		
High	X		X	X	X	1
Medium	X			X	X	2
Low	X			X	X	3
Log only	X					
Disabled						

16. Priority of low temperature alarms

Low alarm prio.

High

Medium

Low

Same setting as for high temperature.

17. Cancelling alarms during defrost

If a defrost signal is registered at a given point, an alarm will not be triggered. When the signal disappears again, alarms will be permitted.

Defrost point no.

Max 65

00

Min 0

Set the point, which follows the defrost signal.

18. Temperature reading offset

Corrections to the sensor signal can be made here.

Temp. offset

Max 10.0 K

00.0 K

Min -10.0 K

The correction is used when the sensor wires are long.

19. Is there a configuration error?

Config. error no. 0

The value on this line is normally = 0.

Any other value indicates that an error has occurred. The explanations are as follows:

0: No error.

1: Incorrect address entered – it cannot be found in the network list or it cannot be used for this point type.

2: Incorrect point entered – the number is outside those permitted for this unit.

3: The unit does not support this point type.

4: The transmitter type is not supported.

5: The input signal specified is already in use as a signal for another point, and this signal has been defined differently.

6: Incorrect setting for defrost signal. The point cannot be found or has not been defined for the type "Defrost".

7: Internal system error. Try turning the unit off and on again.

8: The controller or software version is newer, which means the monitoring unit does not recognise its data. See Appendix 1 for instructions on how to generate a template that can be used in the AK-SM 350.

9: The data is not presented correctly. Try selecting another setting in the function "Template view".

10: The log capacity has been exceeded. Log data cannot be stored for one year. Extend the interval time for one or more readings.

11: Too many 'Template views' have been created.

12: The selected reference point for power meter reading is invalid.

The following settings only apply if "Analogue input" was selected in point 3.

Analogue input - AI

Type	Point setup
Unused	no. 1
Temperature	Name Point 1
Analogue input	Type Analogue input
Digital input	Suppress alarm No
Power meter	Log setting On
Defrost	Log sample rate 15 minutes
Gas detector	Contr. address 00:000
Controller	Input no. 1
Power meter log	Transmitter type 4 - 20 mA
	Unit None
	Max value 100.0
	Min value 0.0
	High alarm limit 50.0
	Low alarm limit -50.0
	Alarm delay 5 min
	High alarm text
	Low alarm text
	High alarm prio. High
	Low alarm prio. High
	Config. error no. 0

This list of settings was previously covered under temperature. Please see the explanation on pages 25-26.

Signal type

Transmitter type
0 - 10 V
4 - 20 mA

This is where you set whether it is a voltage signal or a current signal.

Readout at max. signal

Max value
Max 5000.0
0100.0
Min 0.0

This is where you set the value that will be presented when the input signal is at its highest (max. 10 V or 20 mA).

Unit

Unit
None
%
ppm
Amp
bar
psi

This is where you set the name of the signal.

Readout at min. signal

Min value
Max 5000.0
0000.0
Min 0.0

This is where you set the value that will be presented when the input signal is at its lowest (min. 0 V or 4 mA).

The following settings only apply if "Digital input" was selected in point 3.

Digital (contact function)

- Type
- Unused
- Temperature
- Analogue input
- Digital input
- Power meter
- Defrost
- Gas detector
- Controller
- Power meter log

Point setup		no. 1
Name		Point 1
Type		Digital input
Suppress alarm		No
Log setting		On
Log sample rate		15 minutes
Contr. address		00:000
Input no.		1
Active at		Closed
Alarm delay		5 min
Alarm text		
Alarm prio.		High
Config. error no.		0

This list of settings was previously covered under temperature. Please see the explanation on pages 25-26.

Defination of contact

Active at
Closed
Open

This is where you set whether the function should be active when the input signal is recorded as closed or open.

The following settings only apply if "Power meter" was selected in point 3.

Pulse input

Type

- Unused
- Temperature
- Analogue input
- Digital input
- Power meter
- Defrost
- Gas detector
- Controller
- Power meter log

Point setup no. 1

Name	Point 1
Type	Power meter
Suppress alarm	No
Log setting	On
Log sample rate	15 minutes
Contr. address	00:000
Input no.	1
Pulses pr kWh	100
Scaling factor	1.0
Alarm limit	500.0 kW
Alarm delay	5 min.
Alarm text	
Alarm prio.	High
Preset consumption	0.0 kWh
Last Preset Date	09.12.08 08:28
Yesterday consumption	--- kWh
Last week consumption	--- kWh
Config. error no.	0

This list of settings was previously covered under temperature. Please see the explanation on pages 25-26.

Pulse setting

Pulses pr kWh

Max 65535

00100

Min 1

This is where you set the number of pulses that can be received before one unit is counted out. The unit is given in kW. NB. Only inputs 1 and 2 can be used for pulse counting.

Scaling factor

Scaling factor

Max 9999.0

0001.0

Min 0.1

The reading from the unit can be corrected with a factor so that the readout becomes more comprehensible.
 $KWh = \text{scaling factor} / \text{pulses per KWh}$

Start value/Reset reading

Preset consumption

Max 999999.0 kWh

000000.0 kWh

Min 0.0 kWh

This is where you select a start value or reset the accumulated value of the power meter.

On the next line you can see the date and time of the setting.

The previous day's power consumption

This is where you can read the power consumption for the previous 24 hours.
 Consumption from 0:00 to 24:00.

Power consumption for the past week

This is where you can read the power consumption for the past week.
 Power consumption from Monday at 0:00 to Sunday at 24:00.

The following settings only apply if "Defrost" was selected in point 3.

Defrost

Type

Unused

Temperature

Analogue input

Digital input

Power meter

Defrost

Gas detector

Controller

Power meter log

This list of settings was previously covered under temperature. Please see the explanation on pages 25-26.

Point setup		no. 1
Name	Point 1	
Type	Defrost	
Suppress alarm	No	
Log setting	On	
Log sample rate	15 minutes	
Contr. address	00:000	
Input no.	1	
Active at	Closed	
Alarm delay	5 min.	
Alarm text		
Alarm prio.	High	
Config. error no.	0	

Defrost

With this function the point can receive information about when a defrost is in progress. This information can be used by other points to ensure they do not send temperature alarms during this period.

The alarm function will be enabled if the defrost signal remains on the input.

The following settings only apply if "Gas detector" was selected in point 3.

Gas detector

Type

Unused

Temperature

Analogue input

Digital input

Power meter

Defrost

Gas detector

Controller

Power meter log

This list of settings was previously covered under temperature. Please see the explanation on pages 25-26.

Point setup		no. 1
Name	Point 1	
Type	Gas detector	
Suppress alarm	No	
Log setting	On	
Log sample rate	15 minutes	
Contr. address	00:000	
Scaling factor	1.0	
High alarm limit	200 ppm	
Low alarm limit	100 ppm	
Alarm delay	5 min.	
High alarm text		
Low alarm text		
High alarm prio.	High	
Low alarm prio.	High	
Config. error no.	2	

This setting only applies to gas detectors connected to AK-SM 350 via data communication. If the gas detector is of type DGS, it can be installed on an analogue input.

Gas detector

This function monitors the concentration of refrigerant in the room air. An alarm is generated if the set value is exceeded. Two alarm limits can be set. A "high" is when the critical limit is reached. This is when the alarm is transmitted. A slightly lower threshold will also generate an alarm, but this alarm can be read as a "Leakage check".

Scaling factor

Scaling factor

Max 9999.0

0001.0

Min 0.1

The measurement from the gas detector is recorded as a %, i.e. 0-100.

A factor can be set here so that the display is shown in ppm. Setting = full reading from the gas detector divided by 100. For example, 30000ppm/100=300.

The following settings only apply if "Controller" was selected in point 3.

Controller

Type
Unused
Temperature
Analogue input
Digital input
Power meter
Defrost
Gas detector
Controller
Power meter log

Point setup		no. 1
Name		Point 1
Type		Controller
Log setting		On
Log sample rate		15 minutes
Contr. address		01-006
Template view		1
Config. error no.		0

This list of settings was previously covered under temperature. Please see the explanation on pages 25-26.

Controller address.
(1 or 11 is the network number and cannot be changed.)

Select a predefined set of readouts

Template view
Max 99
01
Min 1

There are several sets to choose from. Select the set that represents the temperature controller in question:

- 1 When it is a temperature controller or a refrigeration application control for one section.
- 2 When it is a refrigeration application control for two sections and a readout for Section 2 is required.
Or it is a compressor or condenser control and a readout of the condenser control is required.
- 3 When it is a refrigeration application control for three sections
- 4 When it is a refrigeration application control for four sections.

Alarm limits

The alarm limits must be set for the different controllers. It is the individual controllers that emit alarms. The alarms are received by the AK-SM 350, which then presents them.

If an alarm limit has to be changed in a controller, this can be done from the AK-SM 350 via the "More details" screen.

The following settings only apply if "Power meter log" has been selected in Point 3:

Log of power meter

This list of settings was previously covered under temperature. Please see the explanation on pages 25-26.

Function

This function collects readings from the "Power meter" function. The readings that are collected can either be the daily or the weekly power meter reading. The collected reading is summarised in the log (point).

Start/Stop

Logging can be started and stopped with the On/Off setting.

Sample rate

This is where you set how often the log value is to be plotted in the graph.

Type

Log type

Daily

Weekly

Select which reading is to be collected.

From point number

Power meter point no.

Max 65

Min 0

Select the point number from which the reading is to be collected. (See pulse input.)

Alarm setup

```

Service setup
-----
Basic setup
Point setup
Alarm setup
  
```

```

Alarm setup
-----
Alarm common setting
Alarm routes
Alarm destinations
  
```

Alarm common settings

This is where you enter the general settings for:

- Alarm routes
- Modem
- "I'm alive alarm"

```

Alarm common setting
-----
Alarm routes                0
Modem baudrate              Default
Modem init. string          at E1 S0=2 &D2 &C1 V1
Autoacknowledge priority    None
Delete active alarms        Start
Delete alarm history         Start
Test alarm                   Off
Test alarm prio.             High
I'm alive alarm              Disabled
  
```

Once one or more alarm routes have been created, this enables settings for them to be set. The settings can be seen on the next page.

Alarm routes

```

Alarm routes
-----
Alarm routes
Max 4
  1
Min 0
  
```

This is where you set the number of alarm routes to be created. An alarm route describes what will be done when an alarm is generated with a given priority at a given time. (The route is set later on.)

Modem initialising string

```

Modem init. string
-----
at E1 S0=2 &D2 &C1 V1
  
```

The factory-set initialising string should only be changed in special circumstances.

Modem baudrate

```

Modem baudrate
-----
Modem baudrate
Default
2400
4800
  
```

The baudrate setting can be changed if this is necessary. The settings "9600" and "19200" are available in addition to the settings shown. Default = "38400".

Automatic cancellation of alarms

```

Autoacknowledge priority
-----
All
High only
Medium only
Low only
Medium and high
Low and medium
None
  
```

Select which alarms are to be auto-acknowledged. (These will be shown in the list of active alarms and they will also be entered under alarm history.)

Tidy up the alarms

This function deletes all the active alarms. You use this function at the start-up of a new plant for which you want to update the alarms that are always active (after activation all the active alarms will be regenerated).

```

Delete active alarms
  Press Enter to start
  Press Esc to cancel
  
```

Clearing the alarm history

Only use this function when no alarms are active. This function deletes all alarms that were previously triggered. Also those are currently active.

```

Delete alarm history
  Press Enter to start
  Press Esc to cancel
  
```

Reset the list by pressing Enter.

Test of alarm function

This function is used to check whether an alarm route and an alarm destination are correctly configured.

```

Test alarm
Off
On
  
```

When "On" is activated, a test alarm will be generated with the alarm priority set for the next function. Repeat the test with the other alarm priorities. When the test is complete, the function should be set to "Off".

Alarm priority to be tested

```

Test alarm prio.
High
Medium
Low
  
```

In addition to the settings shown, "Log only" and "Disabled" are also available.

"I'm alive alarm"

This function will send an "I'm alive alarm" to the alarm destination. The alarm is sent at fixed intervals, and if it fails to arrive at the alarm destination the monitoring unit will indicate that there is a problem.

```

I'm alive alarm
Disabled
Enabled
  
```

Interval for "I'm alive alarm"

```

I'm alive interval
Max 2880 min.
  1440 min.
Min 10 min.
  
```

Set time interval.

Alarm routes

```

Alarm setup
Alarm common setting
Alarm routes
Alarm destinations
  
```

This is where you set how the alarms are to be routed.

The description selects an alarm route. This route sends alarms to "Destination 1" at the store's opening time and to "Destination 2" at the store's closing time.

This setup is displayed so that all alarms are handled at the same time. If you want to distinguish important alarms from each other, you must create several alarm routes. This means each alarm route can handle its own alarm priority.

```

Route 1
Mode Enabled
Priority range All
Day night mode No
Primary destination Buzzer
Alternate destination None
Copy 1 Remote destination 1
Copy 2 None
Copy 3 None
Night primary dest. Remote destination 1
Night alternate dest. None
Night copy 1 None
Night copy 2 None
Night copy 3 None
  
```

Mode

```

Mode
Disabled
Enabled
  
```

Select "Enabled"

Alarm priority

This is where you set which alarms are to be sent along this route.

```

Priority range
All
High only
Medium only
Low only
Medium and high
Low and medium
  
```

In this example, "All" is selected.

Day night mode

This is where alarms are divided up so they are sent to one place at the store's opening time and somewhere else at the closing time.

Day night mode

No

Yes

In this example, "Yes" is selected. (With the setting = "Yes", the bottom five lines are visible in "Route display". The lines contain "Night functions".)

Night alternate destination

If the alarm cannot be transmitted to the primary destination, it will be sent to the alternate destination.

Night alternate dest.

None

Remote destination 1

Remote destination 2

This destination can be, for example, a service company, which will acknowledge night-time alarms, but only if there is no contact with destination 1.

Primary destination

Primary destination

None

Remote destination 1

Remote destination 2

Remote destination 3

Remote destination 4

Relay 1

Relay 2

Buzzer

SMS 1

SMS 2

SMS 3

In this example, "Buzzer" is chosen, i.e. the internal buzzer is activated if alarms go off at the opening time.

Night copy xx

This destination will receive a copy of all the alarms sent.

Night copy 1

Buzzer

SMS 1

SMS 2

Here an SMS destination has been selected.

Alternate destination

(In this example no alternate destination is selected for the opening time.)

Copy 1

Copy 1

None

Remote destination 1

Remote destination 2

In this example we are choosing to send a copy of the alarm to a service company (Remote destination no. xx).

In the store's closing period:

Another set of destinations are set for the closing period. They are as follows:

Night — Primary dest.

Night primary dest.

None

Remote destination 1

Remote destination 2

This destination can be a monitoring centre which acknowledges night-time alarms. (The choice of settings is greater than shown here. The complete list can be viewed above in the "Primary destination" display.)

Alarm destinations

Alarm setup
Alarm common setting
Alarm routes
Alarm destinations

This is where you set who or what **can** be enabled in the event of an alarm. Below you will see an overview of the destinations. The settings are shown on the next few pages.

Overview

Remote destination

Destination 1	◀0000000▶
Mode	Disabled
Connection type	None

Data can be set on up to four destinations, that are to be connected via a modem or TCP/IP. The settings are described **overleaf**.

Destination 2	◀0000000▶
Mode	Disabled
Connection type	None

Destination 3	◀0000000▶
Mode	Disabled
Connection type	None

Destination 4	◀0000000▶
Mode	Disabled
Connection type	None

Buzzer in monitoring unit

Buzzer	◀0000000▶
Mode	Disabled
Auto mute time	0 min.

Will only be set if the buzzer is to be used in an alarm situation. The settings are described **three pages** on from here.

Remote destination via SMS

SMS 1	◀0000000▶
Mode	Disabled
Phone number	

Data can be set on up to three destinations. The settings are described **three pages** on from here.

SMS 2	◀0000000▶
Mode	Disabled
Phone number	

SMS 3	◀0000000▶
Mode	Disabled
Phone number	

Remote destination

```

Destination 1 ◀◀00000000▶▶
Mode Disabled
Connection type None
    
```

There are three options for this setting:
 Enabled. Which is the default setting.
 Disabled. Where alarms are not sent to the destination. This setting is necessary during setup.
 Suspend. Where the destination will not receive alarms within the next number of hours. The time is also set with this function.
 When the time has run out, the setting will automatically change to "Enabled".

This is where you select how the connection is to be established: Settings can only be made in "Disabled" mode.

```

Connection type
None
Ethernet
Modem
Dialback
    
```

Ethernet

When the connection is to be via Ethernet, the following settings apply:

```

Destination 1 ◀◀00000000▶▶
Mode Disabled
Connection type Ethernet
Destination name default
Password 123
Host name or IP addr.
    
```

Name

```

Destination name
    
```

Type in the desired name. The name is also the ID for calls to the monitoring unit via the IP network.

```

Password
Max 999
123
Min 0
    
```

Enter the password.

Host name or IP addr.

```

Host name or IP addr.
    
```

Type in the name or IP address.

Example of number structure = 192.186.0.100

Do not forget the full stops between the groups of numbers.

Modem

When the connection is to be via Modem, the following settings apply:

```

Destination 1 ◀◀00000000▶▶
Mode Disabled
Connection type Modem
Destination name default
Password 123
Phone number
    
```

```

Destination name
    
```

Type the name. The name is also the ID for the call to the monitoring unit via modem.

```

Password
Max 999
123
Min 0
    
```

Enter the password.

```

Phone number
    
```

Type in the phone number for the alarm destination.

Dial back

This function is used during modem connection and when transferring logs to a service company. This is what happens:

- The service company calls the monitoring unit.
- The dial back function is enabled.
- The connection is broken.
- After a short while the monitoring unit itself rings the set destination. The destination can then retrieve logs and alarms.

The following settings are available:

Destination 1	
Mode	Disabled
Connection type	Dialback
Destination name	default
Password	123
Phone number	

Destination name

Type the name.

Password

Max 999

Min 0

Enter the password.

Phone number

Type in the phone number.

If there are more Remote destinations (Destinations 2, 3 and 4), they must be set up in the same way.

The buzzer in the monitoring unit

This function is used if the buzzer in the monitoring unit will be enabled in an alarm situation. Select the "Buzzer" setting.

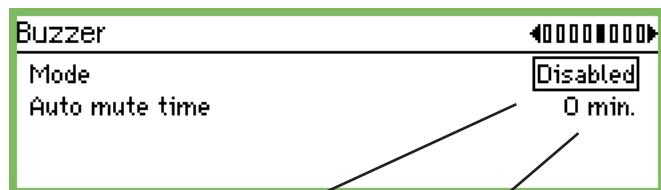

There are three options for this setting:
 Enabled. When the buzzer will be enabled for alarms.
 Disabled. When the buzzer will not be enabled for alarms. This setting is necessary during setup.
 Timed. Where the buzzer will not sound alarms within the next number of hours. The time is also set with this function. When the time has run out, the setting will automatically change to "Enabled".

This is where you select how long the buzzer must be enabled for if there is an alarm.
 With the setting = 0, the buzzer will be continuously enabled at alarms. The buzzer is not disabled until the alarm button on the front panel is enabled and "set alarm" is acknowledged. (2)

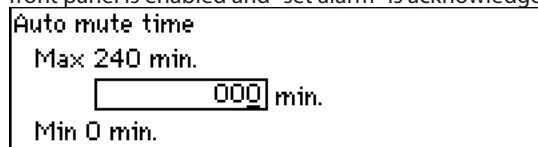

With a setting greater than 0, the buzzer will be active for the set amount of time.

Remote alarm destinations via SMS

This function is used if an SMS is to be sent to a destination when an alarm occurs. Select the setting "SMS 1".



There are three options for this setting:
 Enabled. When the destination can expect to receive alarms.
 Disabled. When the destination will not receive any alarms. This setting is necessary during setup.
 Timed. Where the destination will not receive alarms within the next number of hours. The time is also set with this function. When the time has run out, the setting will automatically change to "Enabled".

This is where you set the phone number of the SMS destination.

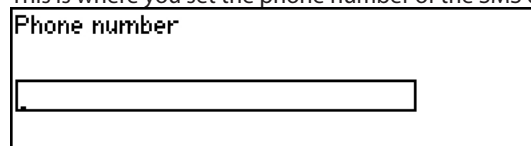

If there are more SMS message destinations (SMS 2 and SMS 3), they must be set up in the same way.

Print setup

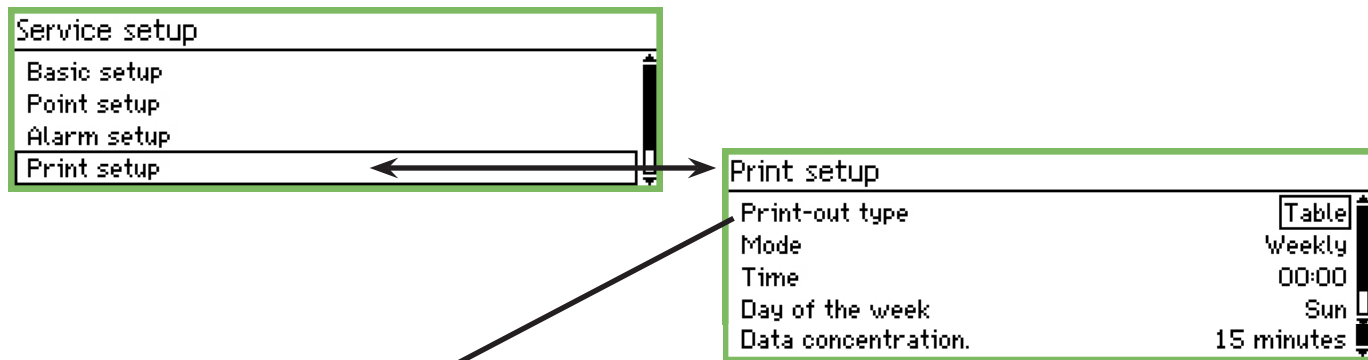

Graph or table

Select how the readings will be presented

Print-out type

Graph

Table

Choose between Graph or Table. In the following screenshot you can see the settings that appear if Table has been chosen.

Data concentration

With this function the measured values recorded can be presented in concentrated form. A series of readings is averaged here, so only the points' mean temperatures are shown.

Example

A reading is taken every 15 mins. The setting is set to 1 hour.

The values shown are the average for the 4 readings.

Data concentration.

15 minutes

1 hour

4 hours

12 hours

24 hours

Set the length of time over which the averaging should take place.

The frequency of the print-outs

Mode

Off

By hour

Daily

Weekly

Monthly

Select one of the possible periods. In the following screenshot you can see the settings that appear if weekly has been chosen.

The time of day of the print-outs

Time

00:00

Set the time.

The day of the week of the print-outs

Day of the week

Sun

Mon

Tue

Set the day.

IP setup

```

Service setup
Alarm setup
Print setup
IP setup
Relay setup
  
```

If AK-SM 350 is using IP, the settings should be done as follows.

```

IP setup
IP address mode      Dynamic
Host name           H313734303934
IP address          010.007.037.127
Subnet mask         255.255.255.000
  
```

Select whether the address should be Dynamic or Static.

If the system is to be called up from the AKM or from the Service tool, "Static address" should be used.

When using Static, the address should be obtained from the local IT department.

Relay setup

```

Service setup
Alarm setup
Print setup
IP setup
Relay setup
  
```

There are 2 relays in the unit. They can be used for 2 of the following:

- Modem relay
- Watchdog relay
- Alarm relay

```

Relay setup
Modem relay
Watchdog relay
Alarm Relay A
Alarm Relay B
  
```

Modem

```

Modem relay
Relay no.      Not used
  
```

This function turns the modem off and on every six hours.

```

Relay no.
Not used
Relay 1
Relay 2
  
```

If the function is used, one of the relays must be selected. Set which one.

Watchdog function

This function will enable one of the two relays at fixed intervals. An external unit will monitor whether the relay is activated. If it is not enabled, the external unit will generate an alarm.

```

Watchdog relay
Mode      Enabled
Relay no.      Not used
Interval    10 min.
Monitor alarm routing  Yes
  
```

If the function is used, it must be enabled.

```

Mode
Disabled
Enabled
  
```

Relay for watchdog function

```

Relay no.
Not used
Relay 1
Relay 2
  
```

If the function is used, one of the relays must be selected. Set which one.

Time interval for watchdog function

```

Watchdog interval
Max 240 min.
  010 min.
Min 5 min.
  
```

Set the interval between the relays being enabled.

Watch alarm routes

This function belongs with the Watchdog function and will stop the interval activation of the relay if the following is in evidence:

- The modem cannot forward an alarm
- The modem cannot forward an SMS
- There is no contact via ethernet

```

Watch alarm routes
No
Yes
  
```

Alarm relay in the monitoring unit

This function is used if one of the two relays in the monitoring unit is to be enabled in an alarm situation. Select either the setting for "Relay A" or the setting for "Relay B". (The relays can be used for a modem connection or watchdog connection. If this is the case, the setting will not work as an alarm relay.)

```

Relay setup
Modem relay
Watchdog relay
Alarm Relay A
Alarm Relay B
  
```

```

Alarm Relay A
Mode Enabled
Relay no. Not used
Type Until reset
Priority range All
Auto mute time 0 min.
Time schedule Always
Relay status Off
  
```

This function has to be activated.

Select relay

```

Relay no.
Not used
Relay 1
Relay 2
  
```

Select which of the two relays is to be used.

Relay function

```

Type
Until reset
Follow state
Follow state,Until reset
  
```

Select how the relay is to be active during an alarm:

- Active until the alarm button is pressed (see and acknowledge)
- Active as long as the fault is present
- Active until alarm reset is enabled

(The time can be limited. See "Automatic reset alarm".)

Alarm priority range

```

Priority range
All
High only
Medium only
Low only
Medium and high
Low and medium
  
```

Select the alarm priority range for which this function is to be active.

Automatic relay reset

```

Auto mute time
Max 240 min.
  000 min.
Min 0 min.
  
```

This is where you select how long the relay must be enabled for if there is an alarm.

With the setting = 0, the relay will be continuously enabled at alarms. The relay is not disabled until the alarm button on the front is enabled and "set alarm" is acknowledged.

Alarm schedule

```

Time schedule
Always
Day only
Night only
  
```

This is where you select when the alarm relay is to be activated.

- Always (even day and night)
- Day only
- Night only

Relay status

This display shows the status of the relay.

Setup for other networks via protocol interface

Use AK-PI 200 as interface for DANBUSS.
Use AK-PI 100 as interface for Woodley units.

The AK-PI unit's address must be set in the following menu:

```

Service setup
IP setup
Relay setup
Protocol Interface setup
Alarm priorities
    
```

```

Protocol Interface setup
PI 1      00:000
PI 2      00:000
    
```

Addresses can be set for 2x AK-PI xxx.
For all other settings, refer to the manual for the AK-PI unit.

Alarm priorities

AK-SM 350 can issue the following alarms. The importance of the alarms can be set as "high", "medium" or "low".

```

Service setup
IP setup
Relay setup
Protocol Interface setup
Alarm priorities
    
```

```

Alarm prio. - System
Contr. communication error  High
Possible network failure   High
Alarm Router full          High
Alarm Route failure        High
    
```

```

Contr. communication error
High
Medium
Low
    
```

Press the "right arrow" to set the other alarm priorities.

Daily use

When there is an alarm

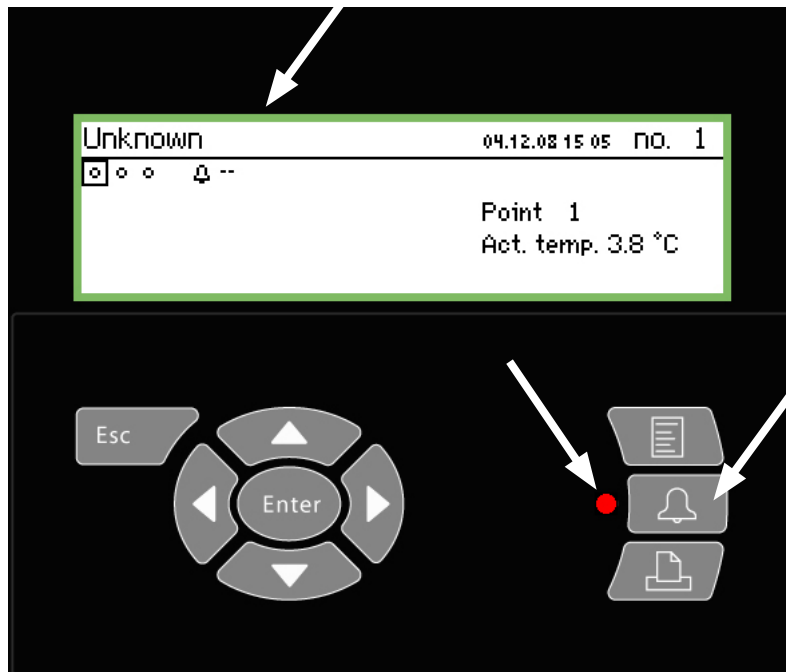

You can do the following when the alarm sounds:

- Press the alarm button twice and the noise will stop
- Look through the list of the active alarms
- Take action to deal with the error

When there is an alarm, an alarm symbol will appear by the point from which the alarm originates. At the same time, the LED by the alarm button will flash.

By pressing the alarm button in this situation, all active alarms will be displayed.

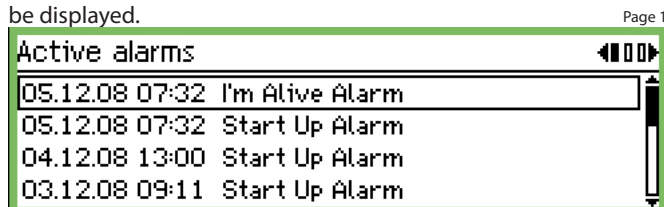

(The Alarm history screen is "one push to the right" of the Active alarms screen.)

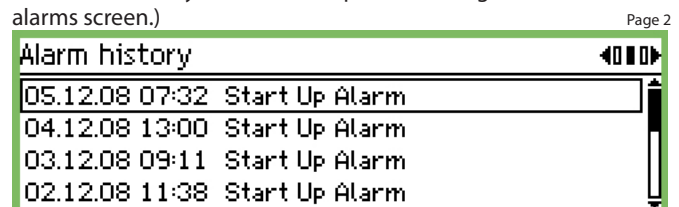

Select one of the alarms and then press the "Enter" button. You will now see more information about the alarm.

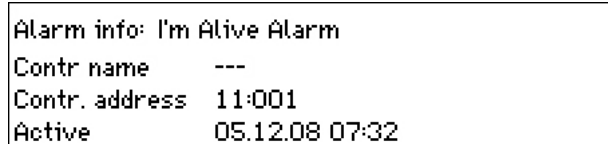

Now the alarm has been seen, it is up to you to make sure that someone does something about it to correct the error. Later on, when the error has been rectified, the alarm shown will be cleared from the "Active alarms" screen. But you will always be able to find it in the "Alarm history" screen.

Further on to the right is the "Event log" screen, i.e. who, when and what has been done.

You can also see here when an alarm was confirmed.

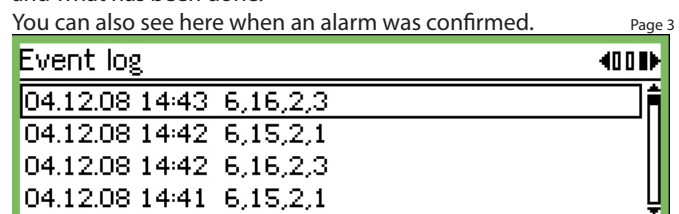

(Only for trained personnel.)

When you want to print out a data collection

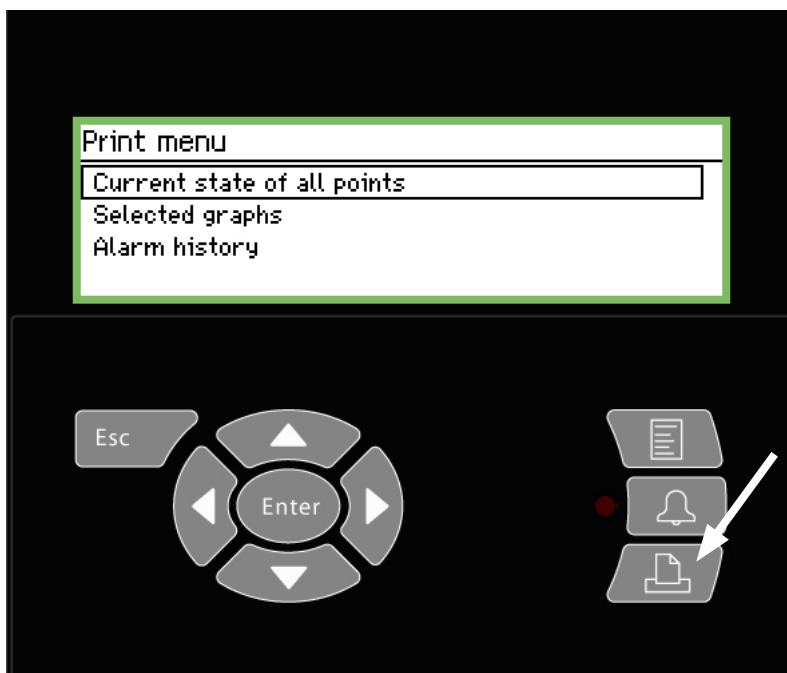

Example of point state

Point state		AM	Page
Point number:	Point name	State	
1	M2+ 8005 001 Point 1	OK	
7	EKC 301 7516	Alarm	
8	EKC 301 7517	OK	
9	EKC 301 7518	Alarm	
27	Loca1 08	OK	
28	Loca1 09	OK	
29	Loca1 10	OK	
30	Loca1 11	OK	

Example of alarm history

Alarm history		AM	CMB	Page
Selected period:				
29.03.06 11:59				
28.03.06 11:59				
Date	Controller address & name	Cancelled	Acknowledged	
29.03.06 10:59	11:001 AM Test CMB Defrost comm. error 01:040	29.03.06 10:59		
29.03.06 10:58	01:023 EKC device 023 Low temp alarm	01.01.70 00:00	29.03.06 10:58	

1. Connect a printer (HP PCL-3 compatible) to the monitoring unit.
2. Press the Printer button
3. Select one of the three printout options. Start printing.
If you would like another time period than the one suggested by the monitoring unit, the period can be changed.

Print setup:
See page 40.

Current state of all points

Current state of all points printout	
Start printing	Start
Printer state	Ready

Help screen for the three functions: This is where you start printing.

Start printing
Press Enter to start
Press Esc to cancel

Selected graphs

Selected graphs printout	
Start printing	Start
Start date & time	04.12.08 07:46
End date & time	05.12.08 07:46
Printer state	Ready

Help screen for the two functions: This is where you set the start and end times.

Start date & time
<u>04.12.08 07:49</u>

Alarm history

Alarm history printout	
Start printing	Start
Start date & time	04.12.08 07:49
End date & time	05.12.08 07:49
Printer state	Ready

End date & time
<u>05.12.08 07:49</u>

When you want to see a graph of the collected temperatures

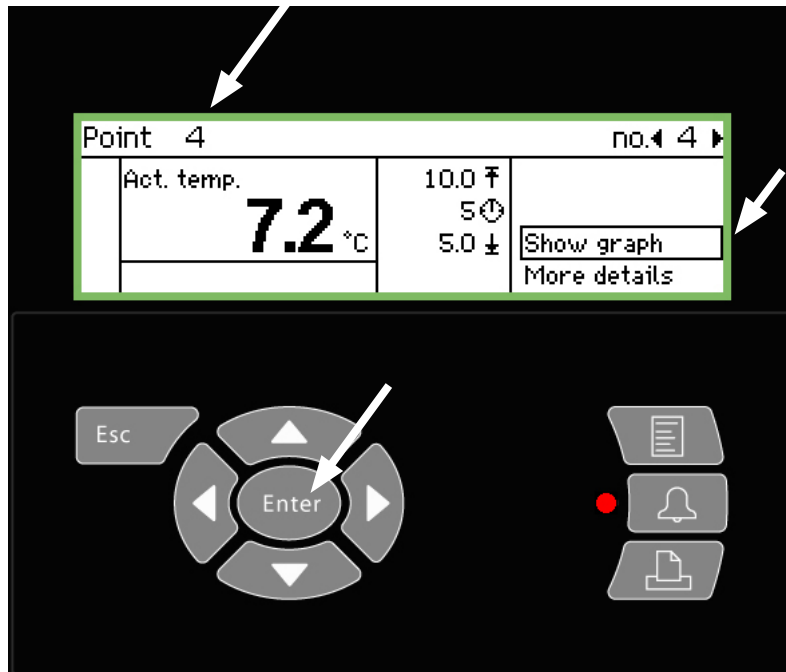

Example

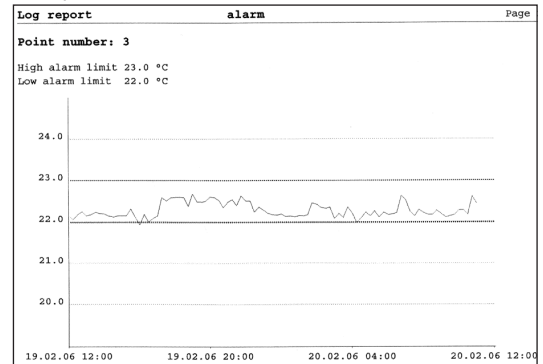

1. Select the point for which you want to see a graph. Point 4 has been chosen here.
2. Press "Enter" when the line "Show graph" is highlighted.

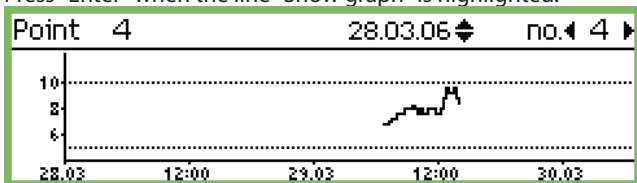

The scaling of the vertical axis is determined by all the values and by the two alarm limits. Here these are 5 and 10°C (If these values are set too far outside the range, the graph will be compressed.)

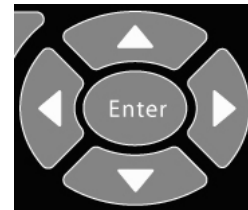

3. Press "Enter" again and a vertical line will appear along the time axis.

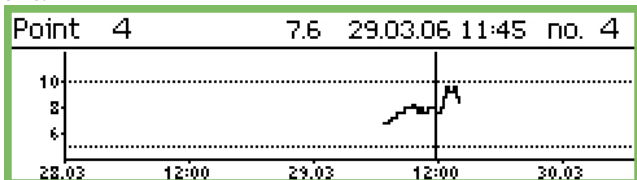

You can move this vertical line by pressing the "left arrow" or "right arrow".

You can follow the position of the line in the top line. This is where the date and time is given. On the left of the date you can see the corresponding temperature value.

You can move the line "back in time" and see more temperatures that were collected earlier. When you go back far enough, e.g. a year, there will not be any more values. These values have been deleted from the memory to make room for newer values.

Zoom out

The screen will begin with a time period of 2 days. If you want to see a longer period, you must press the "up arrow". You can press this several times. By doing this you can change the period to 4, 8, 16 or 32 days.

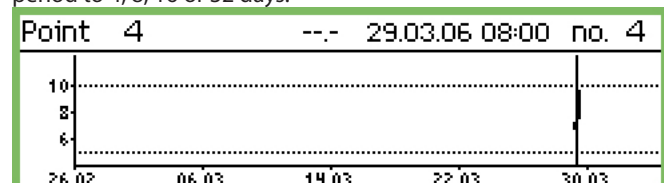

You can zoom in again by pressing the "down arrow".

When you want to change the store's opening times (day/night settings)

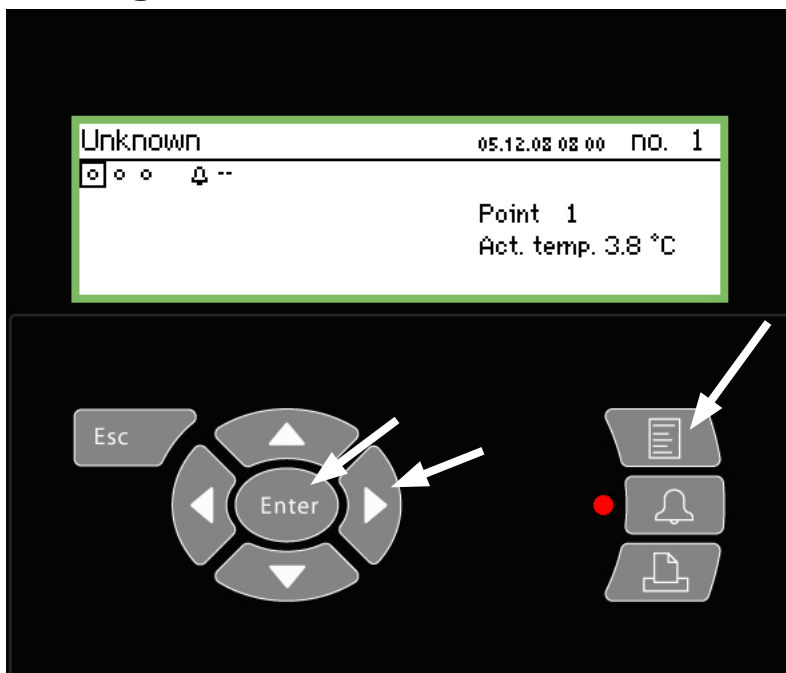

To the end user
 This function is an option, but is only relevant if controllers or functions have been installed that can receive the signals in question.
 Or if external alarm destinations have been created, for which alarms are sent to different places depending on whether it is a day or night period.

To the installer
 Please put a cross in the box if the day/night function is used.

- Yes
- No

1. Press the Menu button

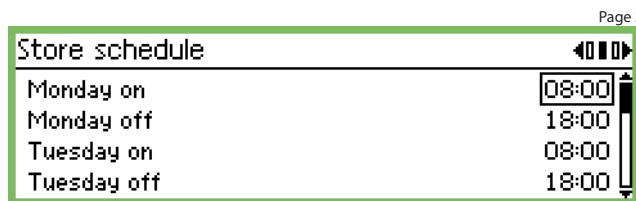
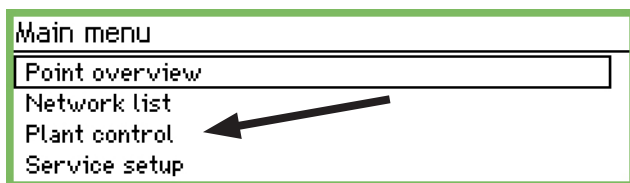

2. Select the "Plant control" line

3. Press "Enter"

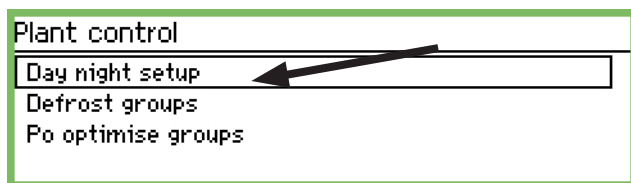

7. This is where you change the times

The times are used for alarm routing and day/night signals to the controllers.

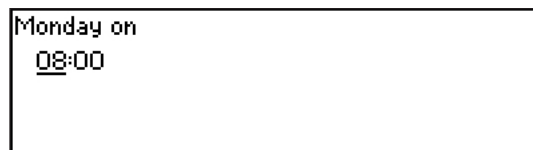

The hour setting and minute setting is entered using the arrow keys.

4. Select "Day night setup"

5. Press "Enter"

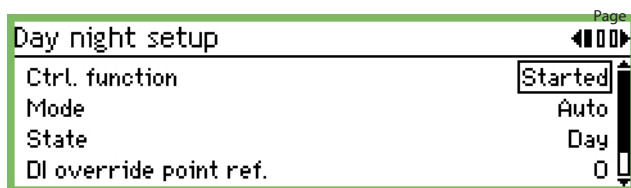

6. Press the "right arrow"

When you want to change the defrost times

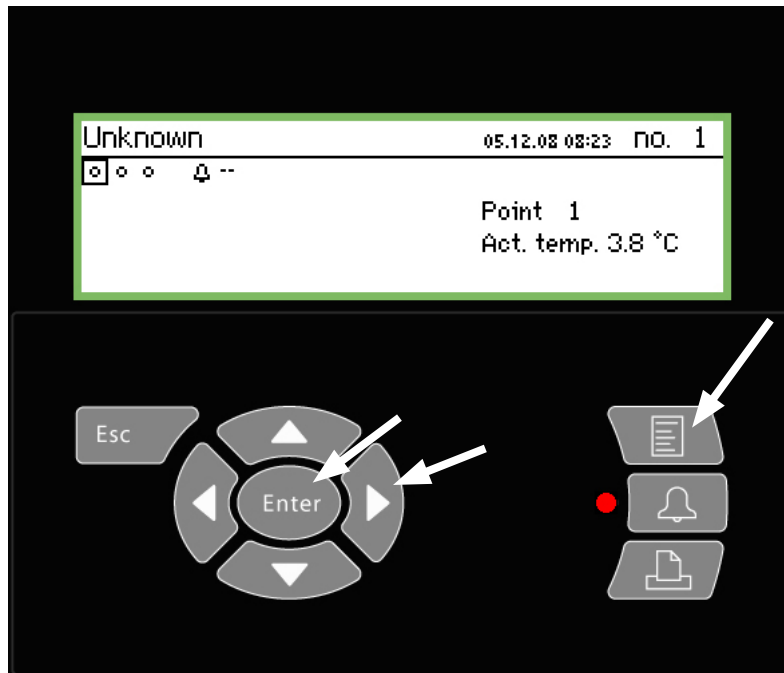

To the end user
This function is an option, but is only relevant if controllers or functions have been installed that can receive the defrost signal.

To the installer
Please put a cross in the box if the defrost function is used.

Yes
 No

1. Press the Menu button

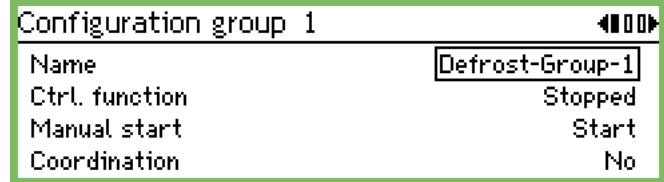
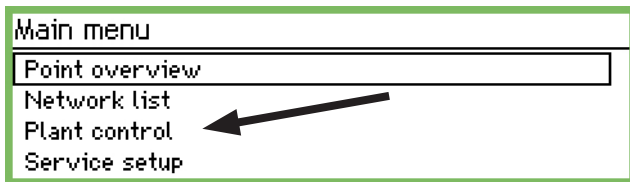

Page 1

2. Select the "Plant control" line

3. Press "Enter"

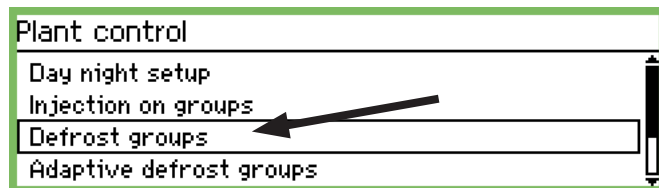

8. Press the "right arrow"

page 2

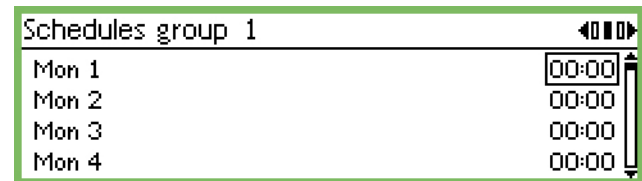

4. Select defrost group

5. Press Enter

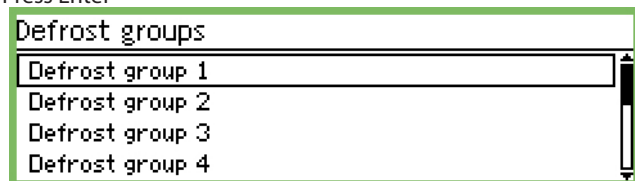

9. This is where you change the times
The defrost cycle will start at the set times.

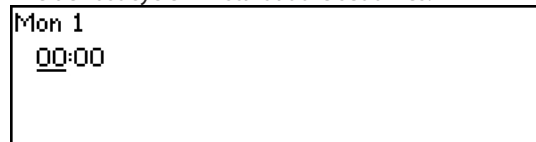

6. Select one of the defined defrost groups

7. Press "Enter"

The hour setting and minute setting is entered using the arrow keys.
The time point 00.00 will **not** start a defrost.

10. Repeat procedure for any other defrost groups.

Appendix - Template compiler

Application

This function is used to define the way controller measurements are displayed on the front of the AK-SM 350 when a customer-specific display is required or if there is no factory-defined template for display, for example if a completely new kind of controller is added for which the AK-SM 350 does not have a template.

1. Connection

Connect service tool AK-ST 500 to the AK-SM 350.
Start the function in the service tool program

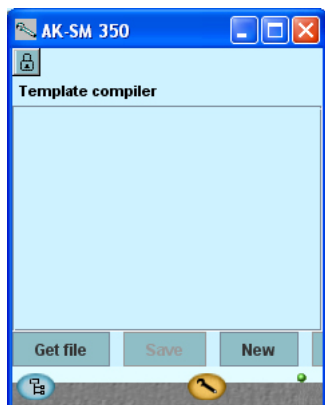
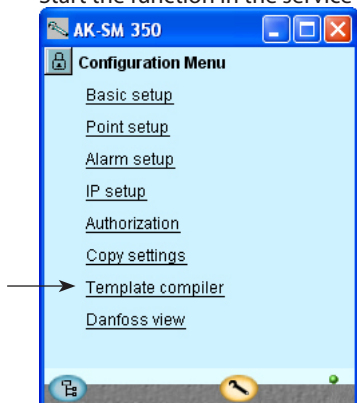

2. New template

To create a new template, you need to tell the program which controller and which parameters are available. Click on "NEW" and the service tool program will display all the controllers recognised by the program (to which the service tool program has previous connected). Find the relevant code number and software version and continue by clicking "OK". (An example is shown on the right.)

Example

If you cannot find the code number or software version in the list, you can retrieve it as follows:

1. Connect the controller to the AK-SM 350
2. Enter an address in the controller
3. Start the "Scan" function
4. Read the code number and software version from the network overview
5. Connect to the controller via the network overview.
6. Restart the template function.

3. Settings

Enter the settings as shown on the following pages

4. Save

Once you have finished entering the settings on the following pages, save the template on the relevant AK-SM 350. The template you save on the AK-SM 350 will overwrite any existing template. Any previous template (factory-defined or user-defined) for the controller in question will be deleted.

Revision

Use this function if you want to upload to the PC and work on a user-defined template already in the AK-SM 350.

Click on "Get file" and retrieve the file for editing

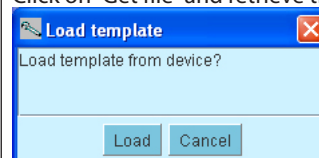

Settings

To construct a template, start with the AK-SM 350 "Point detail" display screen.

The display screen is divided into 5 sections. The first 4 are shown below::

Left-hand side: 4 symbols, e.g. fan, refrigeration, defrosting, alarm

Top middle: The most important display, e.g. the appliance temperature (This display is also shown in the point over view.)

Bottom middle: A secondary display, e.g. the temperature at the defrosting sensor

Right-hand side: Secondary display, e.g. alarm limits and time delays

The fifth section is a little further to the right and may contain more details.

The following pages show the settings for the individual sections

You can set up several "Views" for the same controller type. You can decide which view you want to use when setting up the point.

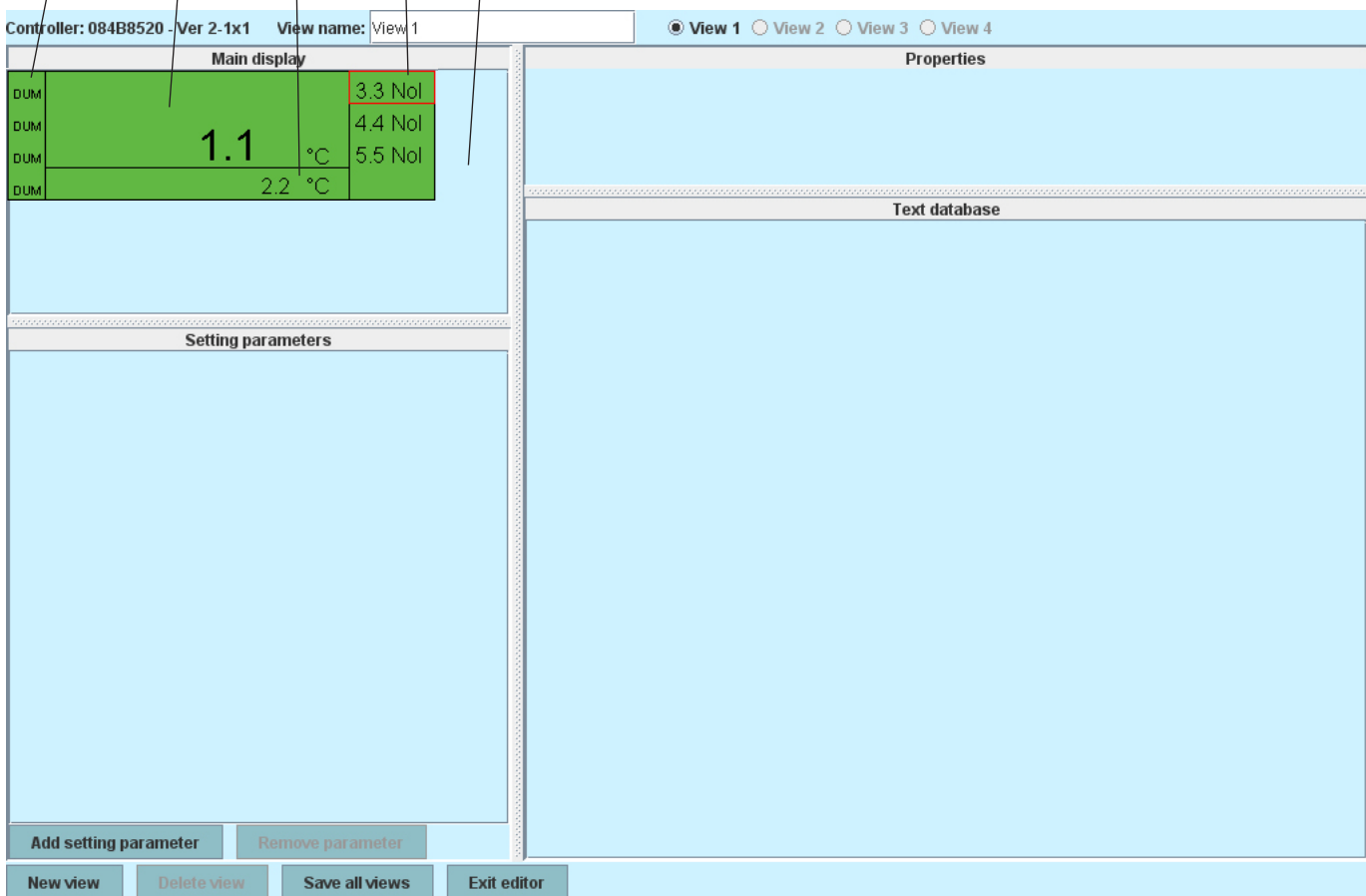

General

1. Select the section you want to set up (the section is shown with a red border)

2. Then go to the "Properties" field and select a parameter

Parameter group:

Parameter:

Select the top line and find the parameter you want to display in the field. You can read about parameter groups in the controller manual, and also find more information about the function.

Double-click on the group to display a range of parameters. Select the parameter (in our example "u59 Fan relay") and confirm with "OK".

3. The next page contains the specific settings for the individual sections.

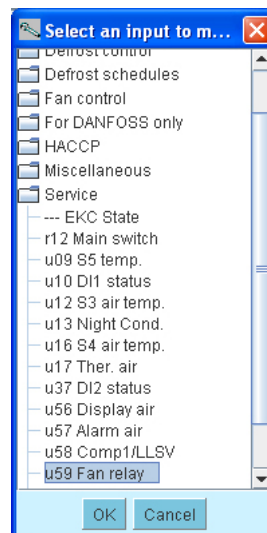

Left-hand side: Symbols

FAN		3.3
DUM	1.1	4.4
DUM	-	5.5
DUM	2.2	-

Examples:

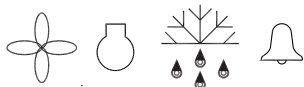

Parameter group: Service

Parameter: u59 Fan relay

Icon type: FAN_STATE

- FAN_STATE
- COMPRESSOR_STATE
- DEFROST_STATE
- ALARM_STATE
- DUMMY

Dummy = no symbol

Top middle: The most important display

FAN	VXCVXC	3.3
DUM	1.1	4.4
DUM	°C	5.5
DUM	2.2	-

Parameter group: Thermostat control

Parameter: u17 Ther. air

Text: VXCVXC

Display type: TEMP

- BASIC
- THERMODYNTEMP
- PRESSURE
- WORK
- POWER
- REFRIGERCAPACITY
- POWERCONSUM
- TEMPDIFF

- TEMP
- MIN
- PERCENTAGE
- HHMM
- OK_FAULT
- NUMBER
- STOPPEDSTARTED
- HOURS

To display the temperature, select "TEMP".
 To display the pressure, select "PRESSURE".
 For numerical values, select "BASIC"
 For the On/Off function, select "ONOFF" or "OFFON"

- BOOL
- OFFON
- ONOFF
- FAN_STATE
- COMPRESSOR_STATE
- DEFROST_STATE
- ALARM_STATE
- DUMMY

Dummy = no symbol

Bottom middle: A secondary display

FAN	VXCVXC	3.3
DUM	1.1	4.4
DUM	°C	5.5
DUM	sdssds	2.2 °C

Parameter group: Service

Parameter: u09 S5 temp.

Text: sdssds

Display type: TEMP

Right-hand side: Secondary display, e.g. alarm limits and time delay

FAN	VXCVXC	3.3 MaL
DUM	1.1	4.4
DUM	°C	5.5
DUM	sdssds	2.2 °C

Examples:



Parameter group: Alarm settings

Parameter: A13 HighLim Air

Display type: TEMP

Limit icon: MAX_LIMIT

- NO_ICON
- MAX_LIMIT
- MIN_LIMIT
- DELAY
- MAX_MAX_LIMIT
- SETPOINT

No icon = no symbol

Further right: More details

FAN	VXCVCX	3.3 MaL
DUM	1.1 °C	4.4
DUM		5.5
DUM	sdssds	2.2 °C

More details

There is a function in the display that provides access to “More details”

You can specify what is shown here in the “Setting parameters” field.

1. Click on the “Add setting parameter” button
2. Select a parameter
3. Give it a name
4. Select a display type
5. Define the level of access rights to the parameter. There are 4 levels to choose from:
 - “Read only” means that the parameter cannot be edited.
 - “Config lock” means that the user must be logged in using the password for configuration and the configuration must be locked before the parameter can be edited.
 - “Service pw” means that the parameter can be edited if the user is logged in with the password for service.
 - “User pw” means that the parameter can be edited if the user is logged in for user operation.

Setting parameters

hjkhhk --

gsdfgdsfgsdfgdg -- °C

Add setting parameter
Remove parameter

You can select up to 20 parameters in this display.

Parameter group: Alarm settings

Parameter: --- EKC State

Text:

Display type: BASIC ▼

Access rights: Readonly parm. ▼

Readonly parm.
Config lock protected
Service pw protected
User pw protected

Text reuse

All text entered is recorded in a database. When setting up new templates, you can retrieve and reuse this text. Place the cursor in the field where you want to use the name. Then select the text that you want to copy to the field. (The text will only appear in the database once the template has been saved).

Text database

View 1

gsdfgdsfgsdfgdg

hjkhhk

sdssds

vxcvcx

Multiple views?

If you want to have multiple views available in the current template, repeat the settings process for View 2, etc.

Menu survey

Point overview

"Overview display"

"Point display"

Network list

Plant control

Day night setup

- Ctrl. function
- Mode (Setting)
- State
- Status DI override
- DI override point ref.
- DI override controller

Inject on groups

Defrost groups

Adaptive defrost groups

P0 optimise groups

Rail heat groups

Service Setup

Basis setup

- Config. lock
- Scan Network
- Language
- Site name
- Device name
- Daylight saving
- Time zone
- Actual date
- Eng. units
- Service password
- User password
- Network timeout
- Delete offline contr.
- Display scan mode
- Main frequency
- Reset to factory

Point setup

- Name
- Type

Alarm setup

- Alarm common setting
- Alarm destinations

Print setup

- Print-out type
- Mode

IP setup

- IP address mode
- Host name
- IP address
- Subnet mask

Relay setup

- Modem relay
- Watchdog relay
- Alarm Relay A
- Alarm Relay B

Protocol interface AK-PI 200

Alarm priorities

About product

- Order no.
- Serial no.
- SW ver.

Type =

- Temperature
- Analogue input
- Digital input
- Power meter
- Defrost
- Gas detector
- Controller
- Power meter log

Temperature:

- Suppress alarm
- Log setting
- Log sample rate
- Contr. address
- Input no.
- Sensor type
- High alarm limit
- Low alarm limit
- Alarm delay
- High alarm text
- Low alarm text
- High alarm prio.
- Low alarm prio
- Defrost point no.
- Temp. offset
- Config. error no.

Analogue input:

- Suppress alarm
- Log setting
- Log sample rate
- Contr. address
- Input no.
- Transmitter type
- Unit
- Max. value
- Min. value
- High alarm limit
- Low alarm limit
- Alarm delay
- High alarm text
- Low alarm text
- High alarm prio.
- Low alarm prio
- Config. error no.

Digital input:

- Suppress alarm
- Log setting
- Log sample rate
- Contr. address
- Input no.
- Active at
- Alarm delay
- Alarm text
- Alarm prio.
- Config. error no.

Power meter:

- Suppress alarm
- Log setting
- Log sample rate
- Contr. address
- Input no.
- Pulses pr kWh
- Scaling factor
- Alarm limit
- Alarm delay
- Alarm text
- Alarm prio.
- Preset consumption
- Last Preset Date
- Last week consumption
- Config. error no.

Defrost:

- Suppress alarm
- Log setting
- Log sample rate
- Contr. address
- Input no.
- Active at
- Alarm delay
- Alarm text
- Alarm prio.
- Config. error no.

Gas detector:

- Suppress alarm
- Log setting
- Log sample rate
- Contr. address
- Scaling factor
- High alarm limit
- Low alarm limit
- Alarm delay
- High alarm text
- Low alarm text
- High alarm prio.
- Low alarm prio
- Config. error no.

Controller:

- Log setting
- Log sample rate
- Contr. address
- Template view
- Config. error no.

Power meter log:

- Log setting
- Log sample rate
- Log type
- Power meter point no
- Config. error no.

User and operator safety

This unit is safe to operate as long as the instructions in this manual are followed. There is live voltage under the cover, so the cover should not be removed as long as the supply voltage is connected.

Check that the supply voltage is turned off before the cover is removed. The operator of this system is expected to know how to use this unit. Danfoss is not responsible for any loss or damage caused by incorrect operation of the unit.

Validity

This manual was prepared in April 2013 and is valid for the AK-SM 350 with software version 2.5x.

The manual describes the setup and employment of the AK-SM 350 when it is used for monitoring and controlling refrigeration installations.

Danfoss can accept no responsibility for possible errors in catalogues, brochures and other printed material. Danfoss reserves the right to alter its products without notice. This also applies to products already on order provided that such alternations can be made without subsequential changes being necessary in specifications already agreed. All trademarks in this material are property of the respective companies. Danfoss and Danfoss logotype are trademarks of Danfoss A/S. All rights reserved.

