

Data Sheet

Pressure switch
Type **KP**

KP pressure switches are for use in refrigeration and air conditioning systems to give protection against excessively low suction pressure or excessively high discharge pressure.

KP pressure switches are also used for starting and stopping refrigeration compressors and fans on air-cooled condensers.

A KP pressure switch can be connected directly to a single-phase AC motor of up to approx. 2 kW or installed in the control circuit of DC motors and large AC motors.

KP pressure switches are fitted with a single-pole double-throw (SPDT) switch. The position of the switch is determined by the pressure switch setting and the pressure at the connector. KP pressure switches are available in IP30, IP44 and IP55 enclosures.

Features:

- Ultra-short bounce time thanks to snap-action function (reduces wear to a minimum and increases reliability)
- Manual trip function (electrical contact function can be tested without the use of tools)
- Types KP 6, KP 7 and KP 17 with fail-safe double bellows element
- Vibration and shock resistant
- Compact design
- Fully welded bellows element
- High reliability both electrically and mechanically

Product specification

Technical data

Table 1: Technical data

Features		Values
Ambient temperature		-40 – 65 °C (80 °C for max. 2 hours)
Ambient temperature (PED approved units)		-25 – 65 °C (80 °C for max. 2 hours)
Media temperature ⁽¹⁾		-50 – 100 °C
Max. working pressure		LP: PS / MWP = 17 bar
		HP: PS / MWP = 35 bar
		KP 6: PS / MWP = 46.5 bar
Max. test pressure		LP: P _e = 20 bar
		HP: P _e = 35 bar
		KP 6: P _e = 46.5 bar
Contact load	Alternating current	AC1 = 16 A, 400 V
		AC3 = 16 A, 400 V
		AC15 = 10 A, 400 V
		Direct current
		DC13 = 12 W, 220 V control current
Wire dimensions	solid / stranded	0.75 – 2.5 mm ²
	flexible, without ferrules	0.7 – 2.5 mm ²
	flexible, with ferrules	0.5 – 1.5 mm ²
Tightening torque		max. 2 Nm
Rated impulse voltage		4 kV
Pollution degree		3
Short circuit protection, fuse		16 A
Insulation		400 V
Enclosure		IP30 / IP44 / IP55

⁽¹⁾ The media temperature can be out of ambient temperature range under necessary condition that temperature inside KP must be kept in ambient temperature range.

Cable connection

The cable entry can be used for 6 – 14 mm dia. cables. A Pg 13.5 screwed cable entry can also be used for 6 – 14 mm cable. With 8 – 16 mm cable a standard Pg 16 screwed cable entry can be used.

Enclosure

IP30 to EN 60529 / IEC 60529

Enclosure IP30 is obtained when the units without top cover are mounted on a flat surface or bracket. The bracket must be fixed to the unit so that all unused holes are covered.

IP44 to EN 60529 / IEC 60529

Enclosure IP44 is obtained when the units with top cover are mounted on a flat surface or bracket. The bracket must be fixed to the unit so that all unused holes are covered.

KP pressure switches with auto reset are supplied with top cover. For KP pressure switches with manual reset, the top cover must be separately ordered (**code no. 060-109766** for single pressure switches and **code no. 060-109866** for dual pressure switches).

IP55 to EN 60529 / IEC 60529

IP55 is obtained when the KP pressure switches are mounted in an IP55 enclosure, (**code no. 060-033066** for single pressure switches and **code no. 060-035066** for dual pressure switches). IP55 enclosure has to be ordered separately.

Contact systems

Table 2: Low and high pressure

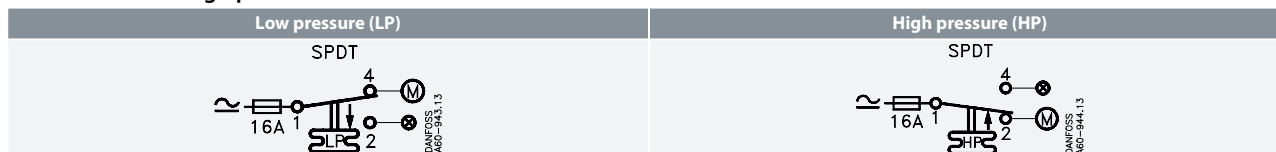
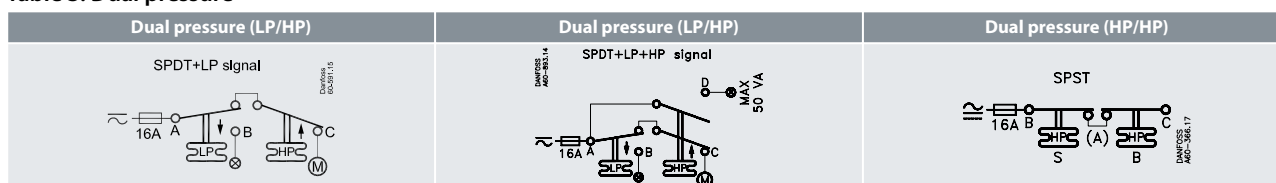

Table 3: Dual pressure



Materials in contact with the medium

Table 4: Materials in contact with the medium

Type	Material
KP 1, KP 2, KP 5, KP 6, KP 7, KP 15 and KP 17	Tinbronze, no. CW452K, EN 1652
	Nickel plated free cutting steel, no. 1.0737 / 1.0718, EN 10277
	Stainless steel 18/8, no. 1.4306, EN 10088-2
	Free cutting steel, no. 1.0737, EN 10277
KP 1A, KP 5A, KP 6A, KP 7A and KP 15A only	Cold forming steel, no. 1.0338, EN 10139
	Steel, no 1.0308, EN 10305
	Free cutting steel, no. 1.0715, EN10277
	Free cutting steel, no. 1.0718, EN 10277
	Aluminium, no. AW-3005, EN 573

Terminology

Reset

1. *Manual (Min. / Max.) reset:*

Units with manual reset can only be reset during operation by activation of the reset button.

2. *Automatic reset:*

After operational stop, these units reset automatically.

3. *Convertible reset:*

Units with optional reset can be activated by automatic and/or manual reset

Permissible working pressure

The permissible working pressure is determined by the pressure that can be safely allowed in the refrigerating system or any of the units within it.

Test pressure

The test pressure is the pressure used in strength tests and/or leakage tests on refrigerating systems or individual parts in systems. The test pressure is designated P_e .

“Snap function”

A certain contact force is maintained until irrevocable “snap” is initiated. The time during which the contact force approaches zero is thus limited to a very few milliseconds. Therefore contact bounce cannot occur as a result of, for example, slight vibrations, before the cut-out point. Contact systems with “Snap function” will change over even when micro-welds are created between the contacts during cut-in. A very high force is created during cut-out to separate the contacts. This force immediately shears off all the welds. Thus the cut-out point of the unit remains very accurate and completely independent of the magnitude of the current load.

Setting

Pressure switches with automatic reset – LP: Set the LP start pressure on the "CUT-IN" scale (range scale). One rotation of the low pressure spindle ~ 0.7 bar. Set the LP differential on the "DIFF" scale. One rotation of the differential spindle ~ 0.15 bar. The LP stop pressure is the LP start pressure minus the differential.

NOTE:

The LP stop pressure must be above absolute vacuum ($P_e = -1$ bar)!

If with low stop pressure the refrigeration compressor will not stop, check to ensure that the differential value has not been set too high!

Pressure switches with automatic reset – HP: Set the HP pressure on the "CUT-OUT" scale. One rotation of the HP spindle ~ 2.3 bar. Set the HP differential on the "DIFF" scale. One rotation of the differential spindle ~ 0.3 bar. The HP start pressure is the HP stop pressure minus the differential.

Start and stop pressures for both the LP and HP sides of the system should always be checked with an accurate pressure gauge.

Pressure switches with manual reset Set the stop pressure on "CUT-OUT" scale (range scale).

Low pressure switches can be manually reset when the pressure is equal to the stop pressure plus the differential. High pressure switches can be manually reset when the pressure is equal to the stop pressure minus the differential.

Design

Table 5: Design

<p style="text-align: center;">Pressure switch, type KP</p>	<p style="text-align: center;">KP 1, KP 2, KP 5</p>
<p style="text-align: center;">KP 15</p>	<p style="text-align: center;">Capillary tube for KP 1A, KP 5A and KP 15A</p>

Pressure switch, Type KP

1.	Low pressure setting spindle, (LP)	11.	HP connection
2.	Differential setting spindle	12.	Switch
3.	Main arm	13.	Terminals
5.	High pressure setting spindle, (HP)	14.	Earth terminal
7.	Main spring	15.	Cable entry
8.	Differential spring	16.	Tumbler
9.	Bellows	18.	Locking plate
10.	LP connection	30.	Reset button

The switch in the KP has a snap-action function where the bellows move only when the cut-in or cut-out value is reached.

The bellows are connected to the low or high pressure side of the system through connection (10) or (11).

The design of the KP gives the following advantages:

- high contact load
- ultra-short bounce time
- high resistance to pulsation
- vibration resistance up to 4 g in the range 0 – 1000 Hz
- long mechanical and electrical life

Table 6: Design

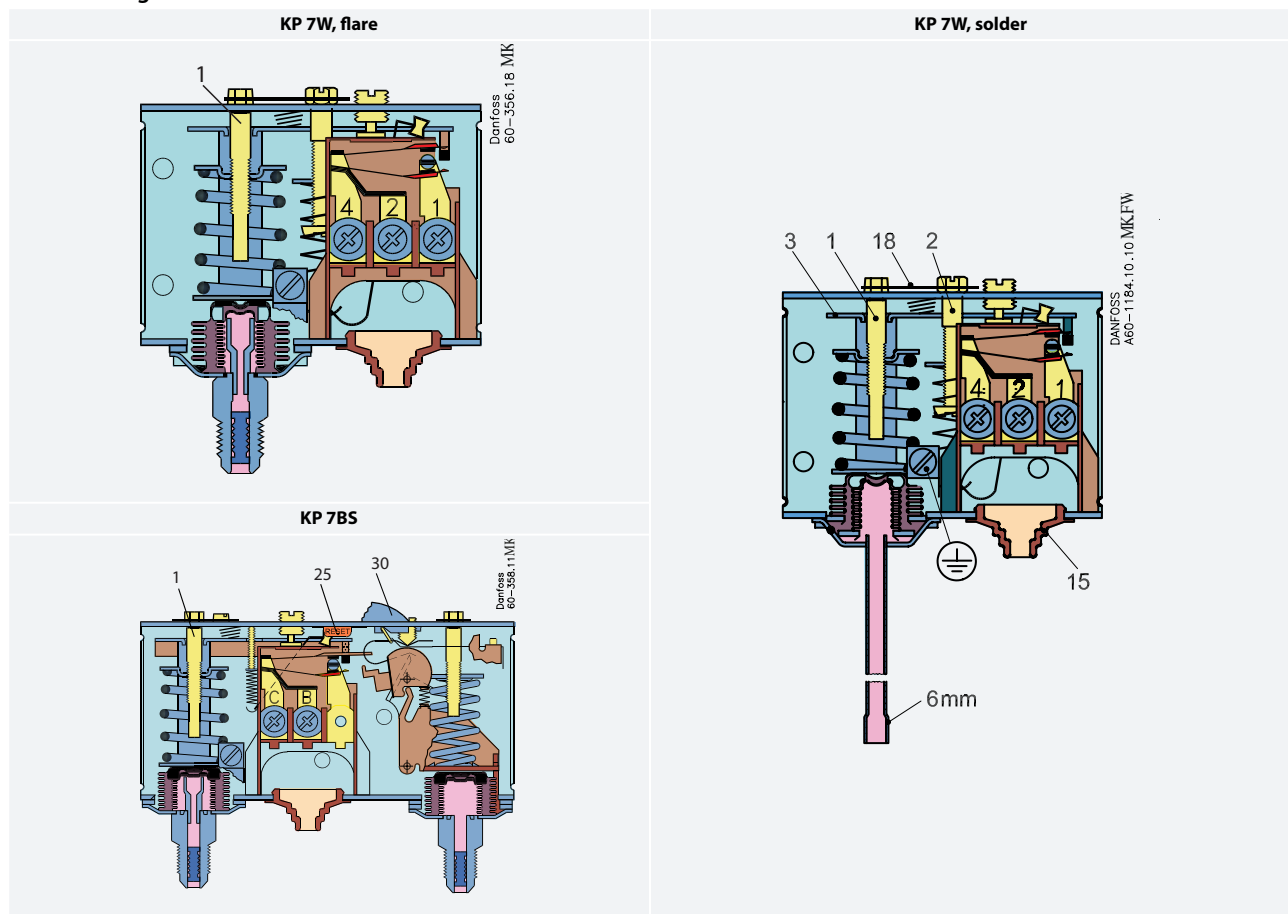

Pressure switch, Type KP

1	Pressure setting spindle	18	Locking plate
2	Differential setting spindle	25	Int. reset arm
3	Main arm	30	Ext. reset button
15	Cable entry		

Types KP1, KP1A, KP2, KP6, KP6A, KP7 and KP17 units with designation W, B or S have been tested and approved by TÜV, Rheinland in accordance with EN 12263.

Types KP6, KP6A, KP7 and KP17 have a double bellows: an outer bellows and a regulating bellows. When system pressure exceeds the set value, the KP will automatically stop the plant. The double bellows system prevents loss of charge in the event of bellows rupture.

A rupture in the inner bellows will cause the control cut-out pressure to fall about 3 times less the set value, thus the refrigeration plant compressor will stop.

A rupture in the outer bellows will cause the control cut-out pressure to fall to about 3 bar under the set value, thus providing a fail-safe function.

Versions with designation W or AW cut in again automatically when the pressure has fallen to the set value minus the differential.

Versions with designation B or AB can be cut in manually with the external reset button when the pressure in KP1 has increased 0.7 bar above set value and in KP6 and KP7 has fallen 4 bar under the set value.

Versions with designation S or AS can be cut in manually with the internal reset arm when the pressure has fallen 4 bar under the set value.

All KP pressure switches, including those which are PED-approved, operate independently of changes in the ambient temperature around the control housing. Therefore the set cut-out pressure and differential are held constant provided the permissible ambient temperatures are not exceeded.

Dimensions [in] and weight [lb]

Table 7: Pressure switches with flare connection

KP 1, KP 2, KP 5, KP 6, KP 7B, KP 7S and KP 7W	KP 15 and KP 17W

Table 8: M10 x 0.75 connection

KP 1A, KP 2A and KP 5A	KP 15A, KP 7AS and KP 7ABS

Pressure switch, Type KP

Table 9: Solder connection

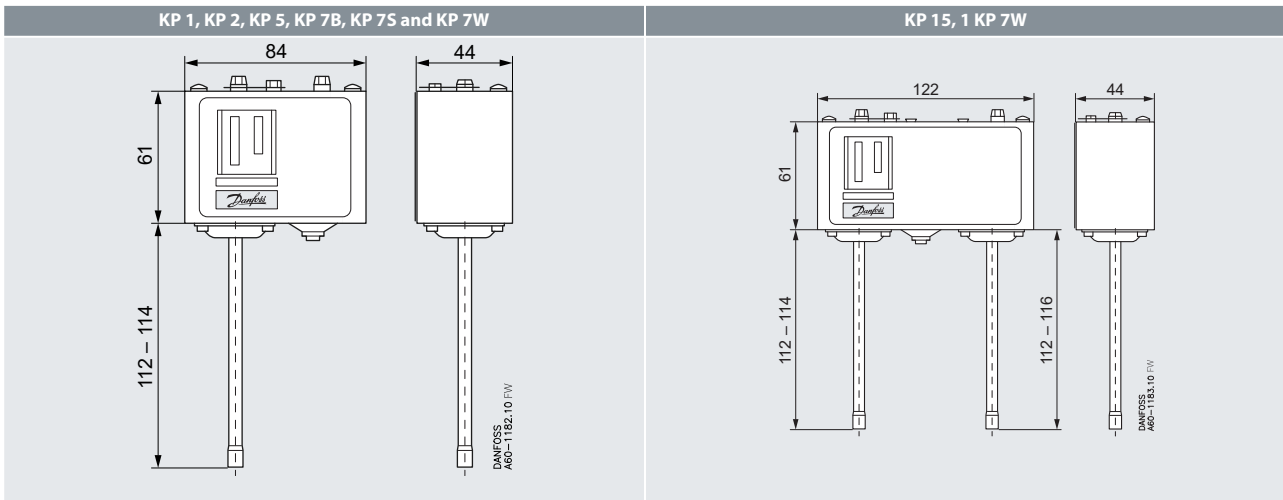
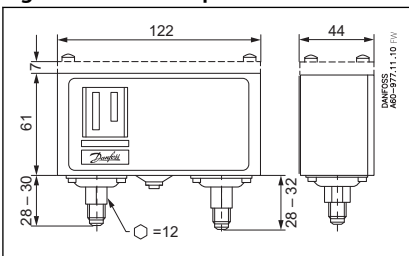

Figure 1: KP with top cover



Net weight:

KP 1, KP 2, KP 5 and KP 7: approx. 0.3 kg

KP 15, KP 17 and KP 7BS: approx. 0.5 kg

KP 1A and KP 5A: approx. 0.3 kg

KP 15A and KP 7ABS: approx. 0.5 kg

Table 10: IP55 enclosure

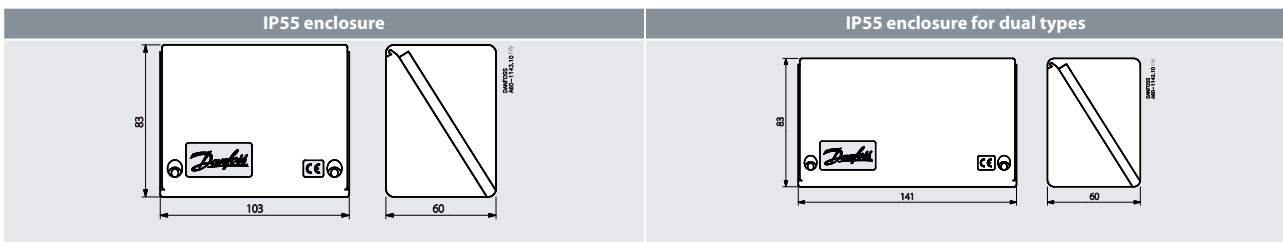
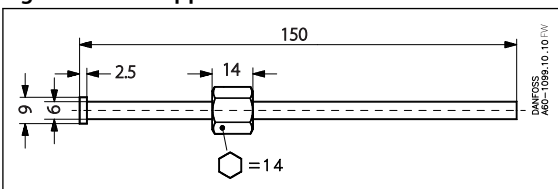
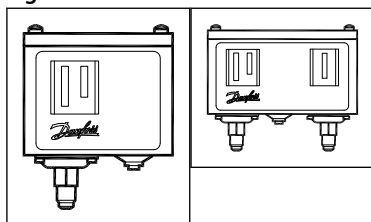

Figure 2: Weld nipple for KP-A



Ordering

Figure 3: KP



For complete list of approved refrigerants, visit www.products.danfoss.com and search for individual code numbers, where refrigerants are listed as part of technical data.

Table 11: For R22, R134a, R404A, R407A, R407C, R407F, R422B, R422D, R448A, R449A, R450A, R452A, R507A, R513A and selected A2L refrigerants: R455A, R454C, R1234yf, R1234yz, R1234ze

Pressure	Type	Low pressure (LP)		High pressure (HP)		Reset		Contact system	Code no.		
		Regulating range [bar]	Differential Δp [bar]	Regulating range [bar]	Differential Δp [bar]	Low pressure LP	High pressure HP		Connection		
									1/4 in. 6 mm flare	1/4 in. ODF solder	6 mm ODF solder
Low	KP 1	-0.2 – 7.5	0.7 – 4.0	–	–	Auto	–	SPDT	060-110166 (1)(4)	060-111266 (4)	060-111066 (4)
Low	KP 1	-0.2 – 7.5	0.7 – 4.0	–	–	Auto	–	SPDT	060-114166 (2)(4)	–	–
Low	KP 1	-0.9 – 7.0	0.7	–	–	Man. (Min.)	–	SPDT	060-110366 (1)	060-111166	060-110966
Low	KP 2	-0.2 – 5.0	0.5 – 1.5	–	–	Auto	–	SPDT	060-112066 (1)(4)	–	060-112366 (4)
High	KP 5	–	–	8 – 32	1.8 – 6.0	–	Auto	SPDT	060-117166 (1)(4)	060-117966 (4)	060-117766 (4)
High	KP 5	–	–	8 – 32	3	–	Man. (Max.)	SPDT	060-117366 (1)	060-118066	–
Dual	KP 15	-0.2 – 7.5	0.7 – 4.0	8 – 32	4	Auto	Auto	SPDT + LP signal	060-124166 (4)	060-125466 (4)	–
Dual	KP 15	-0.2 – 7.5	0.7 – 4.0	8 – 32	4	Auto	Man. (Max.)	SPDT + LP signal	060-124366 (1)	–	–
Dual	KP 15	-0.2 – 7.5	0.7 – 4.0	8 – 32	4	Auto	Man. (Max.)	SPDT + LP signal	060-114866 (2)	–	–
Dual	KP 15	-0.9 – 7.0	0.7	8 – 32	4	Man. (Min.)	Man. (Max.)	SPDT + LP signal	060-124566 (1)	–	–
Dual	KP 15	-0.9 – 7.0	0.7	8 – 32	4	Conv. ⁽³⁾	Conv. ⁽³⁾	SPDT + LP signal	060-126166	–	–
Dual	KP 15	-0.2 – 7.5	0.7 – 4.0	8 – 32	4	Auto	Auto	SPDT + LP and HP signal	060-126566 (1)(4)	060-129966 (4)	–
Dual	KP 15	-0.2 – 7.5	0.7 – 4.0	8 – 32	4	Auto	Man. (Max.)	SPDT + LP and HP signal	060-126466 (1)	060-128466 (1)	–
Dual	KP 15	-0.2 – 7.5	0.7 – 4.0	8 – 32	4	Conv. ⁽³⁾	Conv. ⁽³⁾	SPDT + LP and HP signal	060-115466 (4)	060-001066 (4)	–
Dual	KP 15	-0.9 – 7.0	0.7	8 – 32	4	Conv. ⁽³⁾	Conv. ⁽³⁾	SPDT + LP and HP signal	060-122066	–	–

⁽¹⁾ Available in Asia market with code 060-xxxx91

⁽²⁾ Pressure switches with gold-plated contacts

⁽³⁾ Conv.: optional automatic or manual reset

⁽⁴⁾ Enclosure IP44

For complete list of approved refrigerants, visit www.products.danfoss.com and search for individual code numbers, where refrigerants are listed as part of technical data.

Pressure switch, Type KP

Table 12: For R717, R22, R134a, R404A, R407A, R407C, R407F, R422B, R422D, R438A, R448A, R449A, R450A, R452A, R507A, R513A and selected A2L refrigerants : R455A, R454C, R1234yf, R1234yz, R1234ze

Pressure	Type	Low pressure (LP)		High pressure (HP)		Reset		Contact system	Code no.	
		Regulating range [bar]	Differential Δp [bar]	Regulating range [bar]	Differential Δp [bar]	Low pressure LP	High pressure HP		Connection	
									M10 × 0.75	1 m cap. tube with M10 × 0.75
Low	KP 1A	-0.2 – 7.5	0.7 – 4.0	–	–	Auto	–	SPDT	060-116266 ⁽¹⁾	060-116066 ⁽²⁾
Low	KP 1A	-0.9 – 7.0	0.7	–	–	Man. (Min.)	–	SPDT	–	060-116166
High	KP 5A	–	–	8 – 32	1.8 – 6.0	–	Auto	SPDT	–	060-123066
High	KP 5A	–	–	8 – 32	3	–	Man. (Max.)	SPDT	060-115366 ⁽¹⁾	060-123166
Dual	KP 15A	-0.2 – 7.5	0.7 – 4.0	8 – 32	4	Auto	Auto	SPDT + LP and HP signal	060-129566	060-129366
Dual	KP 15A	-0.2 – 7.5	0.7 – 4.0	8 – 32	4	Auto	Man. (Max.)	SPDT + LP and HP signal	060-129666	060-129466
Dual	KP 15A	-0.9 – 7.0	0.7	8 – 32	4	Conv. ⁽³⁾	Conv. ⁽³⁾	SPDT + LP signal	–	060-128366

⁽¹⁾ Available in Asia market with code 060-xxxx91

⁽²⁾ Enclosure IP44

⁽³⁾ Conv.: optional automatic or manual reset

Pressure switches PED 2014/68/EU approved; EN 12263

For complete list of approved refrigerants, visit www.products.danfoss.com and search for individual code numbers, where refrigerants are listed as part of technical data.

Table 13: For R22, R134a, R404A, R407A, R407C, R407F, R410A(for KP6W, KP6B), R422B, R422D, R438A, R448A, R449A, R450A, R452A, R507A, R513A and selected A2L refrigerants: R455A, R454C, R1234yf, R1234yz, R1234ze

Pressure	Type ⁽¹⁾	Low pressure (LP)		High pressure (HP)		Reset		Contact system	Code no.	
		Regulating range [bar]	Differential Δp [bar]	Regulating range [bar]	Differential Δp [bar]	Low pressure LP	High pressure HP		Connection	
									1/4 in. 6 mm flare	6 mm ODF solder
Low	KP 1	-0.2 – 7.5	0.7 – 4.0	–	–	Auto	–	SPDT	060-110166 ⁽²⁾⁽³⁾	060-111066 ⁽³⁾
Low	KP 1	-0.9 – 7	0.7	–	–	Man. (Min.)	–	SPDT	060-110366 ⁽²⁾	060-110966
Low	KP 2	-0.2 – 5	0.5 – 1.5	–	–	Auto	–	SPDT	060-112066 ⁽²⁾⁽³⁾	060-112366 ⁽³⁾
High	KP 6W	–	–	8 – 42	4 – 10	–	Auto	SPDT	060-519066 ⁽³⁾	–
High	KP 6B	–	–	8 – 42	4	–	Man. (Max.)	SPDT	060-519166	–
High	KP 7W	–	–	8 – 32	4 – 10	–	Auto	SPDT	060-119066 ⁽³⁾	060-120366 ⁽³⁾
High	KP 7B	–	–	8 – 32	4	–	Man. (Max.)	SPDT	060-119166	–
High	KP 7S	–	–	8 – 32	4	–	Man. (Max.)	SPDT	060-119266 ⁽³⁾	–
Dual	KP 7BS	–	–	8 – 32	4	–	Man. (Max.) Man. (Max.)	SPST	060-120066	–
Dual	KP 17W	-0.2 – 7.5	0.7 – 4	8 – 32	4	Auto	Auto	SPDT + LP and HP signal	060-127566 ⁽³⁾	060-127666 ⁽³⁾
Dual	KP 17W	-0.2 – 7.5	0.7 – 4	8 – 32	4	Auto	Auto	SPDT+ LP signal	060-126766 ⁽³⁾	–
Dual	KP 17B	-0.2 – 7.5	0.7 – 4	8 – 32	4	Auto	Man. (Max.)	SPDT	060-126866	060-127466
Dual	KP 17WB	-0.2 – 7.5	0.7 – 4	8 – 32	4	Auto	Conv. ⁽⁵⁾	SPDT + LP and HP signal	060-539766 ⁽³⁾⁽⁴⁾	–

⁽¹⁾ W = PSH (pressure switch), B = PZH (pressure switch with ext. reset), S = PZHH (pressure switch with int. reset)

⁽²⁾ Available in Asia market with code 060-xxxx91

⁽³⁾ Enclosure IP44

⁽⁴⁾ Factory setting: LP side: Range 1 bar Pe, Diff. 1 bar; HP side: Range 18 bar Pe, Diff. 4 bar fixed

⁽⁵⁾ Conv.: optional automatic or manual reset

For complete list of approved refrigerants, visit www.products.danfoss.com and search for individual code numbers, where refrigerants are listed as part of technical data.

Pressure switch, Type KP

Table 14: For R717, R22, R134a, R404A, R407A, R407C, R407F, R422B, R422D, R438A, R448A, R449A, R450A, R452A, R507A, R513A and selected A2L refrigerants: R455A, R454C, R1234yf, R1234yz, R1234ze

Pressure	Type	Low pressure (LP)		High pressure (HP)		Reset		Contact system	Code no.	
		Regulating range [bar]	Differential Δp [bar]	Regulating range [bar]	Differential Δp [bar]	Low pressure LP	High pressure HP		Connection	
									M10 × 0.75	1 m cap. tube with M10 × 0.75
Low	KP 1A	-0.2 – 7.5	0.7 – 4.0	–	–	Auto	–	SPDT	060-116266 ⁽¹⁾	060-116066 ⁽²⁾
Low	KP 1A	0.9 – 7	Fixed 0.7	–	–	Man. (Min.)	–	SPDT	–	060-116166
Dual	KP 7ABS	–	–	8 – 32	Fixed 4	–	Man. (Max.) Man. (Max.)	SPST	–	060-120566

⁽¹⁾ Available in Asia market with code 060-xxxx91

⁽²⁾ Enclosure IP44

Use with A2L refrigerants (R455A, R454C, R1234yf, R1234yz, R1234ze)

⚠ CAUTION:

While using A2L refrigerants the following safety requirements should be followed

Safety requirements

1. KP pressure switches shall only be employed in the units/systems which comply with the requirements for charge limits and requirements for avoiding ignition sources of IEC 60335-2-24, IEC 60335-2-40, IEC 60335-2-89, ISO 5149, EN378-1 or equivalent
2. Applying the overload on the KPs must be prevented. If by any chance it was damaged, the system / unit shall be stopped and KP shall be replaced as necessary
3. Electrostatic discharge protection and Electrical leakage protection shall be surely implemented by grounding or other measures
4. Only trained personnel are authorized to handle flammable refrigerants systems and may do the installation, maintenance and exchange of the switch by using appropriate tools
5. It is recommended to regularly check the function of KP switch
6. The KP pressure switches shall be used as built-in devices that cannot be accessible from outside and protected against mechanical impact
7. The KPs shall be installed in water free environment. In addition, protection of the KP switches against corrosion shall be taken into consideration when using them in corrosive environment
8. Cables shall not be in contact with sharp edges. The cables shall be connected with adequate stress relieve in order to prevent that pulling forces can be carried thorough the cable to the terminal
9. In the event of pressure pulsation in the system, where switch is connected, these must be effectively dumped to prevent failure of the bellows. The cycle frequency of KP switch shall be kept as low as possible
10. The KP switches shall not be installed in places where high level of vibration is present

Electrical rating for use with A2L refrigerants (R455A, R454C, R1234yf, R1234yz, R1234ze)

AC-3: 16 A / 250 V AC

AC-15: 10 A / 250 V AC

Table 15: Electrical rating

Voltage	Current range	Power factor (cos phi)	Frequency
250V AC	≤ 4.0 A	PF ≥ 0,400	50Hz/60Hz
250V AC	> 4.0 to 6.0 A	PF ≥ 0,594	50Hz/60Hz
250V AC	> 6.0 to 16,0 A	PF ≥ 0,780	50Hz/60Hz

Pressure switch setting with convertible reset

Table 16: Pressure switch setting with convertible reset

Low pressure	Manual reset ⁽¹⁾	Automatic reset	Automatic reset	Manual reset
High pressure	Manual reset ⁽¹⁾	Manual reset	Automatic reset	Automatic reset

⁽¹⁾ Factory setting

Certificates, declarations, and approvals

The list contains all certificates, declarations, and approvals for this product type. Individual code number may have some or all of these approvals, and certain local approvals may not appear on the list.

Some approvals may change over time. You can check the most current status at danfoss.com or contact your local Danfoss representative if you have any questions.

Table 17: Certificates, declarations, and approvals

File name	Document type	Document topic	Approval authority
01 202 PL-Q-11 0004	Quality - Assurance Certificate	PED	TÜV
01 202 641-B-19 0006-02	Pressure - Safety Certificate	PED	TÜV
17.20386.258	Marine - Safety Certificate	Marine approval	RMRS
LR 17-20047(E1)	Marine - Safety Certificate	Marine approval	LR
FZ2015006584	Logo Printing Permission	-	CCC
ELE-086320XG-003	Marine - Safety Certificate	Marine approval	RINA
BV 03650-K0 BV	Marine - Safety Certificate	Marine approval	BV
RU Д-ДК.ГА02.В.03367	EAC Declaration	EMC	EAC
DNV GL TAA00001VZ	Marine - Safety Certificate	Marine approval	DNV GL
RU C-ДК.БЛ08.В.00063_18	Electrical - Safety Certificate	EMC/LVEc	EAC
UA.10146.D.00075-19	UA Declaration	EMCD/LVD	LLC CDC EURO TYSK
UL E31024	Electrical - Safety Certificate	-	UL

CE-marked in accordance with:

- LVD 2014/35/EU (EN 60947-1, EN 60947-4-1, EN 60947-5-1)
- PED 2014/68/EU, category IV (EN 12263): KP 1, KP 2, KP 6, KP 7 and KP 17
- Underwriters Laboratories Inc., UL listed China Compulsory Certificate, CCC

Ship approvals

Det Norske Veritas and Germanischer Lloyd, DNV GL

Registro Italiano Navale, RINA

Bureau Veritas, BV

Lloyd's Register, LR

Russian Maritime Register of Shipping, RMRS

Online support

Danfoss offers a wide range of support along with our products, including digital product information, software, mobile apps, and expert guidance. See the possibilities below.

The Danfoss Product Store



The Danfoss Product Store is your one-stop shop for everything product related—no matter where you are in the world or what area of the cooling industry you work in. Get quick access to essential information like product specs, code numbers, technical documentation, certifications, accessories, and more.

Start browsing at store.danfoss.com.

Find technical documentation



Find the technical documentation you need to get your project up and running. Get direct access to our official collection of data sheets, certificates and declarations, manuals and guides, 3D models and drawings, case stories, brochures, and much more.

Start searching now at www.danfoss.com/en/service-and-support/documentation.

Danfoss Learning



Danfoss Learning is a free online learning platform. It features courses and materials specifically designed to help engineers, installers, service technicians, and wholesalers better understand the products, applications, industry topics, and trends that will help you do your job better.

Create your Danfoss Learning account for free at www.danfoss.com/en/service-and-support/learning.

Get local information and support



Local Danfoss websites are the main sources for help and information about our company and products. Find product availability, get the latest regional news, or connect with a nearby expert—all in your own language.

Find your local Danfoss website here: www.danfoss.com/en/choose-region.

Any information, including, but not limited to information on selection of product, its application or use, product design, weight, dimensions, capacity or any other technical data in product manuals, catalogues descriptions, advertisements, etc. and whether made available in writing, orally, electronically, online or via download, shall be considered informative, and is only binding if and to the extent, explicit reference is made in a quotation or order confirmation. Danfoss cannot accept any responsibility for possible errors in catalogues, brochures, videos and other material. Danfoss reserves the right to alter its products without notice. This also applies to products ordered but not delivered provided that such alterations can be made without changes to form, fit or function of the product. All trademarks in this material are property of Danfoss A/S or Danfoss group companies. Danfoss and the Danfoss logo are trademarks of Danfoss A/S. All rights reserved.