

Data sheet

Thermostat

Type UT



The UT thermostat is a temperature-controlled electric switch with stainless steel (18/8) or copper capillary and sensor.

The temperature can be set easily and accurately using the large knob on the front of the thermostat. The temperature must be set to correspond to the required mean temperature.

Features

- The thermostat has a fixed differential
- The temperature must be set in accordance with the required mean temperature
- Electric connections are made by means of cable clamps and terminal screws
- AMP quick connectors may be used in connection with cabinet mounting
- UT is available for wall or panel mounting, and can be used for: cold rooms, beverage coolers, ice cream makers, milk coolers, refrigerated counters, air-conditioning plant, heat recovery systems

Approvals

- CE-marked in accordance with:
- LVD 2006/95/EC (EN 60730-1-2000)
 - EMC directive 2004/108/EC (EN 61000-6-3-2002; EN 61000-6-1-2002)

Technical data

Function range: UT 72 (for universal purposes)	-30 – 30 °C
Function range: UT 73 (for frost protection)	0 – 40 °C
Ambient temperature	-30 – 55 °C
Reset	Automatic
Differential	Fixed, 2.3 K
Switch system	Changeover (SPDT) switch
Contact load	AC-1: 16 A / 250 V
	AC-3: 7.5 A / 250 V
	AC-15: 1 A / 250 V
Capillary tube	Copper or 18/8 steel
Sensor	Copper or 18/8 steel
UT for wall mounting	IP20 to EN 60529 / IEC 529
UT for building in	IP00 to EN 60529 / IEC 529

Ordering

Version	Type	Range	Differential	Reset	Max. sensor temperature	Capillary tube length	Qty.	Code no.	
		[°C]	[K]		[°C]	[m]		Copper	18/8
Wall mounting	UT 72	-30 – 30	2.3	aut.	60	2.0	1	060H1501	060H1506
	UT 72	-30 – 30	2.3	aut.	60	2.0	1	060H1503 ¹⁾	–
	UT 72	-30 – 30	2.3	aut.	60	3.0	1	060H1505	–
	UT 73	0 – 40	2.3	aut.	90	2.0	1	060H1502	–
	UT 72	-30 – 30	2.3	aut.	60	3.0	24	060H1508	–
Building in	UT 72	-30 – 30	2.3	aut.	60	3.0	48	060H1605	–
	UT 73	0 – 40	2.3	aut.	90	2.0	48	060H1602	–

¹⁾ Incl. bulb clamps.

Accessories

Type	Qty.	UT 72	UT 73
Setting knobs	48	060-1067	060-1096
Bulb clamp	36	060-1090	060-1090

Dimensions [mm] and weights [kg]

UT for wall mounting

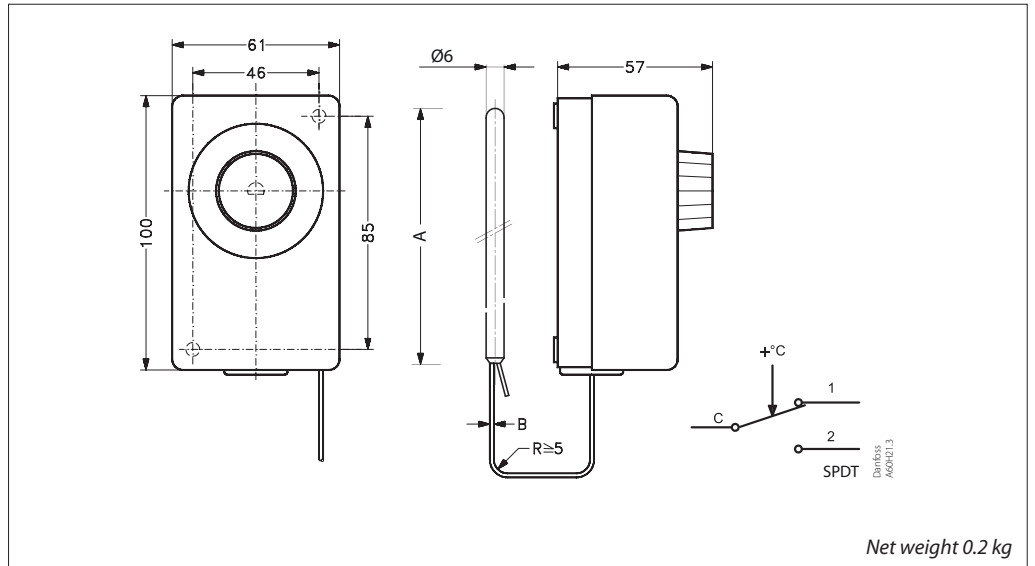

Type	A		B	
	Copper	18/8	Copper	18/8
UT 72	max. 119	max. 150	1.25	0.9
UT 73	max. 119	-	1.25	-

UT for panel mounting

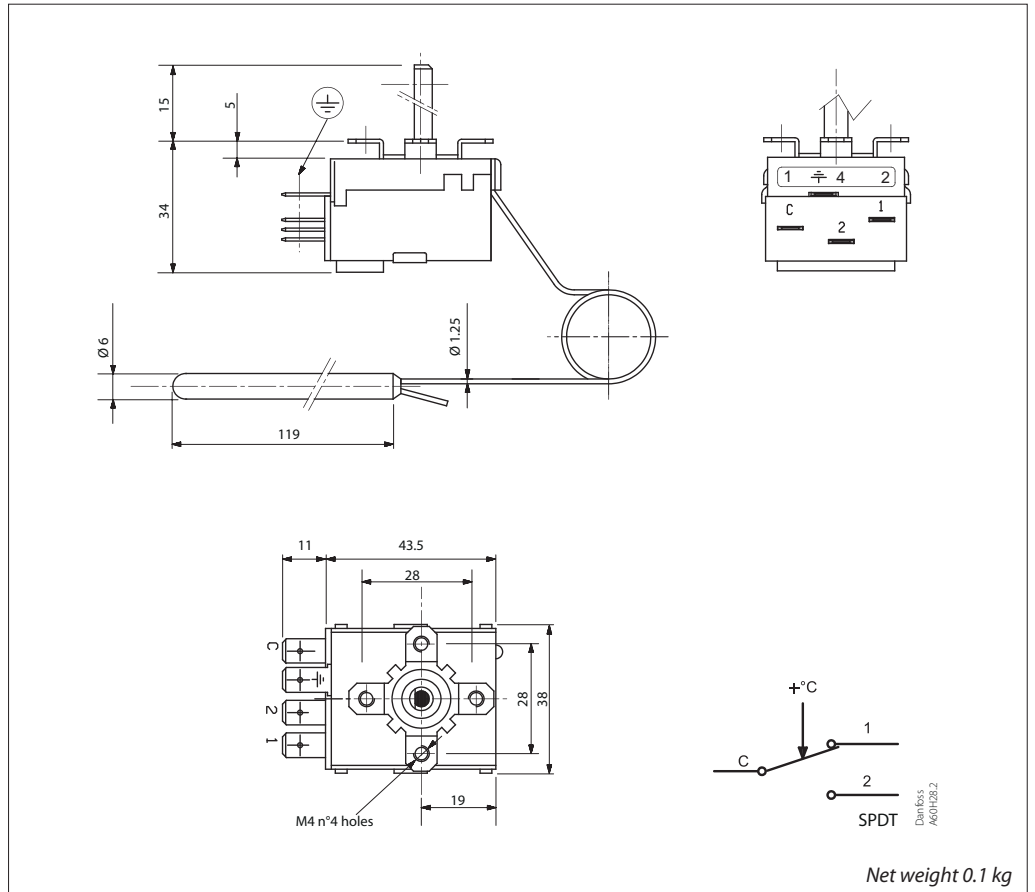

Danfoss can accept no responsibility for possible errors in catalogues, brochures and other printed material. Danfoss reserves the right to alter its products without notice. This also applies to products already on order provided that such alterations can be made without consequential changes being necessary in specifications already agreed. All trademarks in this material are property of the respective companies. Danfoss and the Danfoss logotype are trademarks of Danfoss A/S. All rights reserved.