

ENGINEERING  
TOMORROW



User Guide

## Easy and fast

Apply the MCXWeb tool with your MCX

To ensure that you correctly install your MCXWeb please follow this user guide



[www.danfoss.com/mcx](http://www.danfoss.com/mcx)

## Table of Contents

1. Introduction .....	3
2. MCXWeb components .....	3
3. MCXWeb connections .....	5
4. Web Server and MCX Update.....	6
4.1 Web server firmware update (xport) .....	6
4.2 Web Server software interface update (Web pages).....	6
4.3 MCX061V-MCX152V BIOS Update .....	7
4.4 MCX061V-MCX152V Software Application Update.....	7
5. Web Server User Guide.....	8
5.1 Login .....	8
5.2 Main buttons .....	9
5.3 Network Overview (home page).....	10
5.4 History .....	10
5.5 Alarms .....	11
5.6 Configuration .....	11
5.6.1 Configuration network.....	12
5.6.2 Configuration Template & Files .....	13
5.6.2.1 Create the application template with MCXShape .....	14
5.6.3 Configuration Users .....	15
5.6.4 Configuration System.....	15
5.6.4.1 Network.....	15
5.6.4.2 NTP .....	16
5.6.4.3 Site.....	16
5.6.4.4 Reboot .....	17
5.6.5 Configuration Update.....	18
5.6.5.1 Application Update.....	18
5.6.5.2 BIOS Update.....	18
5.6.6 Configuration History.....	19
5.7 Device pages.....	20
5.7.1 Device Overview .....	20
5.7.1.1 Customization of the Overview page.....	21
5.7.2 Device Details .....	22
5.7.3 Device Alarms.....	23
5.7.4 Device Graphs .....	23
5.7.5 Device Back-up .....	24
5.7.6 Device Restore .....	24
5.7.7 Device Info.....	25
6. MCXWeb Simulator .....	26
7. Appendix - Application template XML structure.....	28

## 1. Introduction

MCXWeb is the online tool used to monitor software applications running into one or more MCX devices connected in a CANbus network. To monitor MCX devices using the MCXWeb you will need to have at least one MCX061V or MCX152V device in the CANbus network, as these are the MCX models that supports Web Server and an Ethernet connection.

The MCXWeb tool can also be used as a simulator for MCX software applications running on a PC for testing and debugging.

### IMPORTANT NOTE.

You can use MCXWeb with popular browsers like Chrome, Firefox, and Safari. Using it with Internet Explorer is not recommended.

This manual refers to the following firmware version or later:

Web Server interface: 2v08

Web Server firmware: 2v23

MCX061V-MCX152V BIOS: 2v22

## 2. MCXWeb components

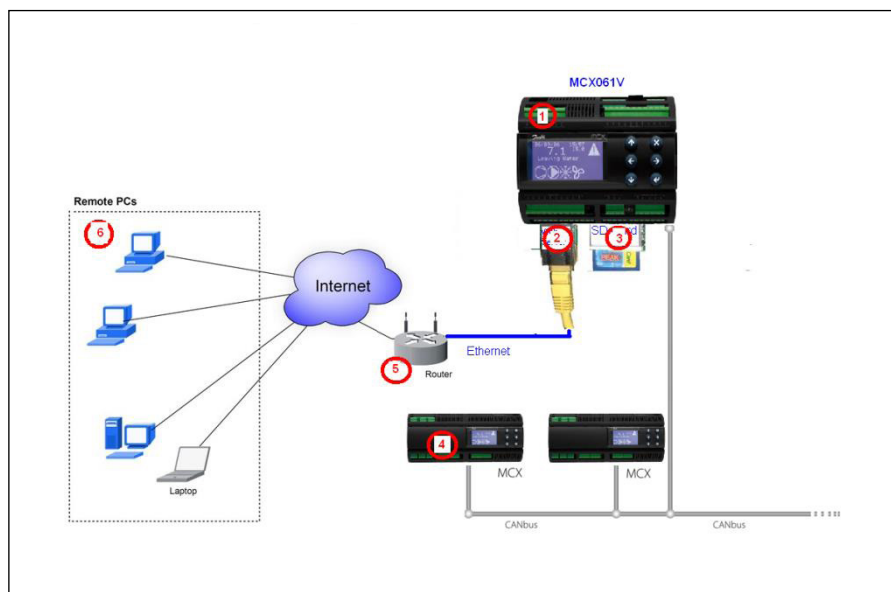

1. MCX061V and MCX152V are the MCX models with Web Server included. Like all other MCX models, MCX061V and MCX152V are fitted with a BIOS and can run application software.
2. Web Server is the software tool included with MCX061V and MCX152V, providing the user with web pages that are displayed on a browser on remote PCs (6). This service needs the following two software elements: Web Server firmware (xport BIOS) and software interface (web pages).
  - The **Web Server firmware** is the file xport\_pro.romz  
MCX061V and MCX152V are provided with Web Server's firmware already installed and should be upgraded only in case of special needs (see Paragraph 4.1 Web Server firmware update).  
The files needed to upgrade Web Server's firmware (BIOS) are included in the MCX-Web update pack available at <http://www.danfoss.com/mcx>

- The **software interface** is the set of the files in the following folders present in the root of the server:



The MCX061V and MCX152V are provided with the Web Server software interface already installed and should be upgraded only in case of special needs (see paragraph 4.2 Web Server software interface update).

All the files needed to upgrade Web Server's software interface are included in MCX-Web update pack available at <http://www.danfoss.com/mcx>

The Web Server software interface includes the folders containing web pages and additional files, for example, the software applications and templates used to configure the MCX present in the MCX CANbus network.

The configuration files should be added or upgraded every time a new MCX device is added to the CANbus network or when there is an upgrade in the MCX firmware or software (see Paragraph 5.6.1, Configuration Network).

3. A memory card is a hardware component used to upgrade the firmware and software of Web Server and of the MCX, and to store log data.
4. MCX devices can be connected via CANbus to the MCX061V and MCX152V, which can be used as web interfaces for all the MCX present in the CANbus network. Each MCX is provided with its firmware (BIOS) and software application. MCX061V and MCX152V must be configured with a template file for each MCX connected, representing the list of variables involved in the communication.
5. A router is a device that connects MCX Web Server to the Internet
6. Remote PCs are the computers where MCXWeb pages are displayed through popular browsers like Chrome, Firefox, and Safari. Using Internet Explorer is not recommended.

### 3. MCXWeb connections

To start using MCXWeb, the first step is identifying the MCX061V or MCX152V in the local network supporting the web server. There are two alternative options.

- 1) Enter in the BIOS menu of MCX061V or MCX152V by pressing and releasing the X and ENTER key at power up.  
 Configure the TCP/IP settings by navigating to the "GEN SETTINGS" – "TCP/IP" screen.  
 You can manually assign the IP address or get it dynamically from the network via DHCP.
- 2) Realize a small local network as in Figure

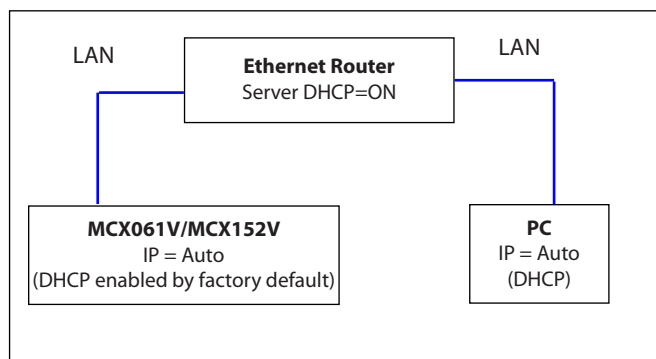

Run the **Gateway Finder** program available at <http://www.danfoss.com/mcx> to find the IP address of your MCX061V or MCX152V:

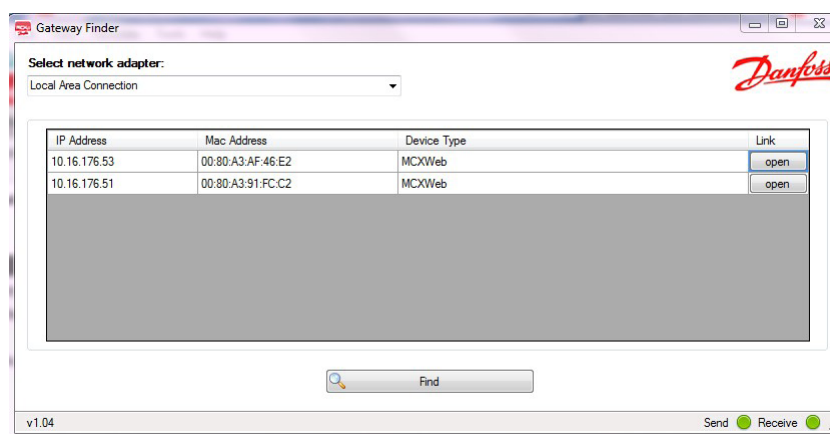

Using the Gateway Finder you get the IP address and MAC addresses of any MCX061V or MCX152V connected to the LAN.

You can then establish a connection with MCX Web Server through a web browser or an FTP client.  
 For the description of the web pages accessible through the web browser, see Paragraph 5, Web Server User Guide.  
 The FTP client is used to update the web server elements when needed. See Paragraph 4, Web Server and MCX Update.

## 4. Web Server and MCX Update

To update Web Server's elements, use a FTP client. We suggest using FileZilla. See Paragraph 3, MCXWeb Connection on how to establish a connection. The parameters to configure the FTP client are as follows:

Host: MCX IP Address (e.g. 192.168.1.xxx)  
 Username: admin (Username is case sensitive)  
 Password: PASS (Password is case sensitive)

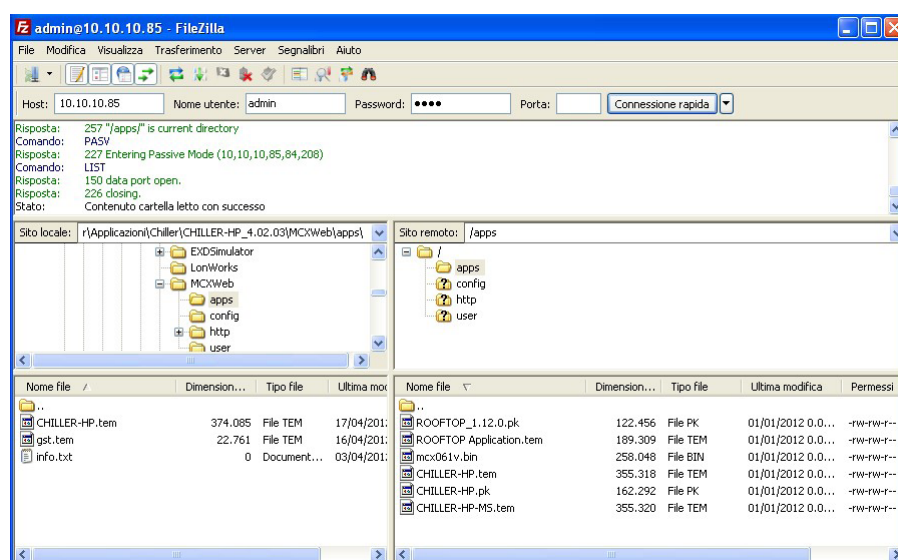

### 4.1 Web Server Firmware Update (xport)

Establish the FTP connection with MCX Web Server as described in Paragraph 3, MCXWeb connection.

To update MCX Web Server's firmware, copy the file xport\_pro.romz in the root of MCX Web Server. The update procedure starts automatically after copying the files. NOTE. The file will be automatically removed during the process.

**WARNING:** DO NOT power off the MCX061V/MCX152V for 2 minutes after the update.

### 4.2 Web Server Software Interface Update (web pages)

If you have executed the Web Server firmware update as described in the previous paragraph, wait two minutes from the start of that procedure before proceeding with the Web Server software interface update.

To update the Web Server software interface, you will need the MCXWeb update pack available at <http://www.danfoss.com/mcx>.

- Establish the FTP connection with MCX Web Server as described in Paragraph 3, MCXWeb connection.
- Remove all the files and folders present on MCX Web Server
- Copy all the following folders, which the software interface is made of, in the root of MCX Web Server.



**WARNING:** do not copy the Web Server firmware (romz file) with the software interface files, otherwise the firmware update process will start (see the previous paragraph) and the web pages will not be updated. If this happens, you must copy the folder of the web pages in the root of the MCX Web Server again two minutes after copying the firmware update.

**WARNING:** after an update operation, MCX Web Server may automatically run a defrag operation to optimize space and performance; this operation makes the MCX Web Server inaccessible for few minutes without any visible signal.

### 4.3 MCX061V-MCX152V BIOS Update

The update for the MCX061V-MCX152V BIOS follows the same procedure of all the other MCX models.

You can update via the CANbus using the MMYMYK or via serial communication using a PC and a USB/485 converter.

In addition to the usual options, with MCX061V and MCX152V it is also possible to update the BIOS via memory card and via web pages.

To update the BIOS via memory card, the procedure is as follows:

- copy the file **mcx061v.bin** or **mcx152v.bin** (the name is case sensitive) in the root of a memory card
- switch off the MCX061V or MCX152V
- insert the memory card into the MCX slot
- switch on the MCX

The BIOS updating procedure will start automatically and the MCX display will show the BIOS splash screen.

To update the BIOS via the web, follow the instructions in Paragraph 5.6.5.2, BIOS Update.

You can also update the BIOS of the MCX connected through CANbus to the MCX061V-MCX152V using web pages.

The file needed to upgrade the BIOS is available in the BIOS pack at <http://www.danfoss.com/mcx>

### 4.4 MCX061V-MCX152V Software Application Update

Updates to the application software running on MCX061V or MCX152V follow the same procedure as all other MCX models.

You can update via the CANbus using the MMYMYK or via serial communication using a PC and a USB/485 converter.

In addition to the standard update methods, MCX061V and MCX152V can also be updated using an application, a memory card and web pages.

To update the application software via memory card, the procedure is as follows:

- copy the file **app.pk** (the name is case sensitive) in the root of a memory card
- switch off the MCX
- insert the memory card into the MCX slot
- power on the MCX.

The application will be automatically copied from memory to the MCX061V or MCX152V and executed.

To update the application software using the web pages, follow the instructions in Paragraph 5.6.5.1, Application Update. When updating with web pages, you can also update the MCX's application software connected through the CANbus to the MCX061V-MCX152V.

## 5. Web Server User Guide

### 5.1 Login

Launch an internet browser from the PC connected to the local network and type the IP of the MCX061V or MCX152V (see Paragraph 3, MCXWeb Connection) in the address bar.

**WARNING.** You can use popular browsers like Chrome, Firefox, and Safari. Using Internet Explorer is not recommended.

Enter your user name and password to log in to the MCXWeb interface  
User name and password are defined in Configuration > Users. By default, they are **admin** and **PASS**.

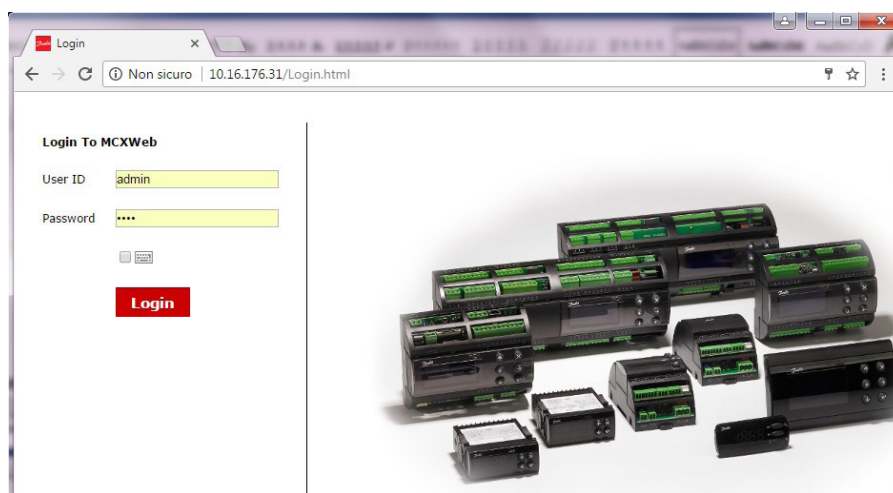

If you are using a virtual keyboard (e.g. for touch screens) check the box beside the keyboard icon under the password field

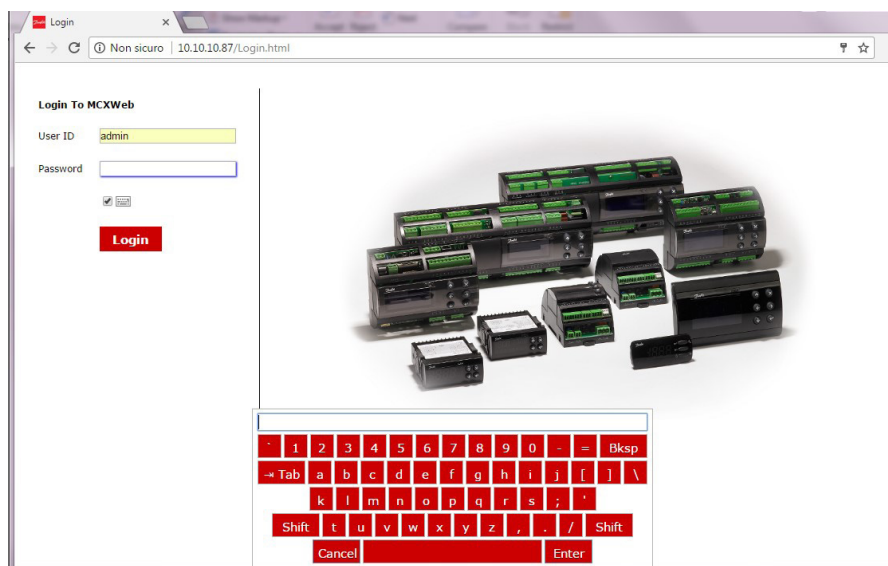



## 5.2 Main Buttons

The main buttons can be found at the top right of all the MCXWeb pages after login.



They are used for:



Back to home page (Network Overview)



Back to login page



Site information:

- Version of the MCXWeb software interface
- Version of the Web Server firmware in the MCX061V – MCX152V
- Version of MCX061V-MCX152V BIOS
- Serial number of the MCX061V – MCX152V
- MAC address of the MCX061V – MCX152V
- License information

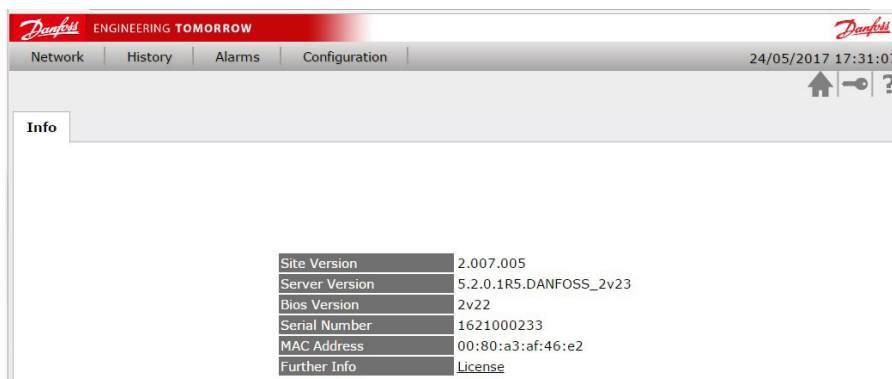

### 5.3 Network Overview (home page)

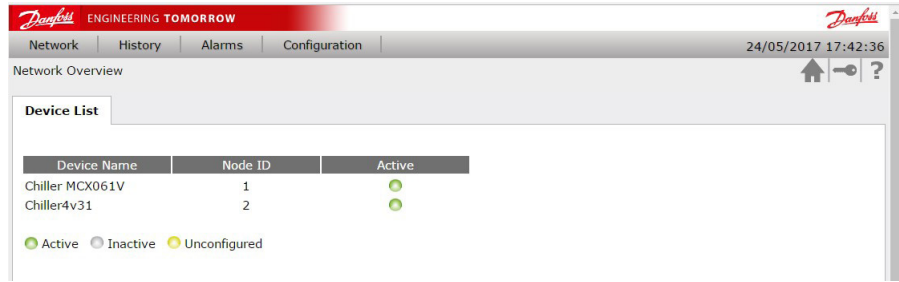

The Network overview is used to list all the devices connected in the CANbus Network to the MCX061V-MCX152V.

For each MCX device detected on the network, the following information is displayed:

- "Device Name" is the name defined in Configuration > Network
- "Node ID" is the CANbus address defined in the BIOS of the MCX device
- "Active" displays the device status:
  - A green dot means that the device is active (configured and connected)
  - A yellow dot means that the device is not configured: the template (tem) file has not been associated with this device (see Paragraph 5.6.1, Configuration Network).
  - A grey dot means that the device is inactive and not connected.

If you click the line with the device you are interested in, you will enter the device specific pages. If the device is active, you will see the pages populated with live values (see Paragraph 5.7, Device Pages).

### 5.4 History

On this page you can graph historic data.

Select the variables you want to display as a graph, the date and period and then select Draw.

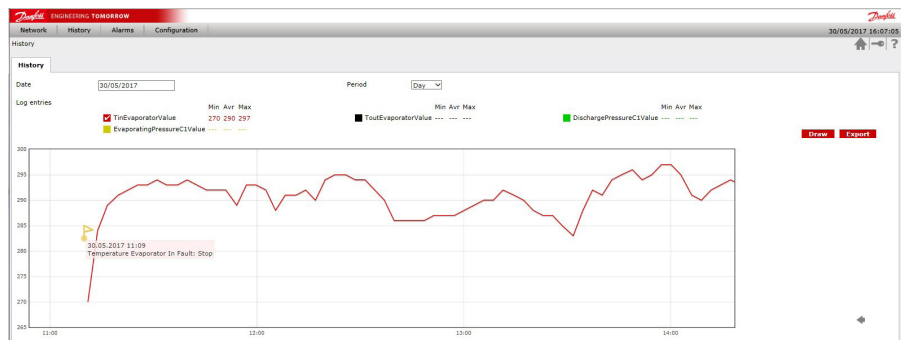
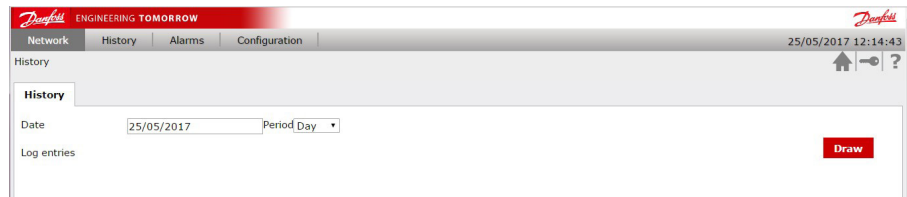

You can use the mouse wheel to zoom in and out of the graph and the arrows on the bottom right corner to move the graph's time period back and forward.

The graph may also display events (yellow flags); use the mouse to click a flag to view additional information on the relevant event.



Press Export to export history data in CSV format.

## 5.5 Alarms

This page displays the list of the alarms active in all the devices connected to the CANbus network.

Alarm	Device Name	NodeID
Alr. Probe Tin Evaporator	Chiller MCX061V	1
Alr. Probe DischargePress C1	Chiller MCX061V	1
Alr. Probe DischargePress C2	Chiller MCX061V	1
Alr. Probe Oil Press Comp1	Chiller MCX061V	1
Alr. Probe Oil Press Comp2	Chiller MCX061V	1
EEV1 S2 Error	Chiller MCX061V	1
Expansion communication fault	Chiller MCX061V	1
Alr. Probe DischargePress C1	Chiller4v31	2
Alr. Probe DischargePress C2	Chiller4v31	2
Alr. Probe Oil Press Comp1	Chiller4v31	2
Alr. Probe Oil Press Comp2	Chiller4v31	2
Expansion communication fault	Chiller4v31	2

## 5.6 Configuration

The Configuration menu is used to configure items under the following headers: Network, Template, Users, System, History.

Is also used to update the software (application) and firmware (BIOS) of the devices. The configuration menu is visible only to users with service or admin access levels.

Device Name	Node ID
mcx061v	1
mcx20b	2

### 5.6.1 Configuration Network

This page shows which devices are connected in the CANbus network. You can also manually add new devices by pressing the Add button and setting the ID (CANbus address) of the device to be added.

For each device in the list you must specify the description (free text) and the application template.

The application template is a file with a *tem* extension containing the description of variables and parameters of the software application running in the MCX device.

Templates must be 1) created, 2) loaded and 3) associated

The template is associated to the device through the combo menu in the Application column.

This combo menu is populated with all the *tem* files created with MCXShape and transferred into the MCX061V-MCX152V following the instruction in the next paragraph.

Use the special entry "HIDDEN NODE" if you want to hide some nodes in the network overview or if they do not have a template. This is typically used for nodes such as User Interfaces (e.g. MMIGRS) or Accessories (e.g. MMIMYK)

Press Save to save the changes.

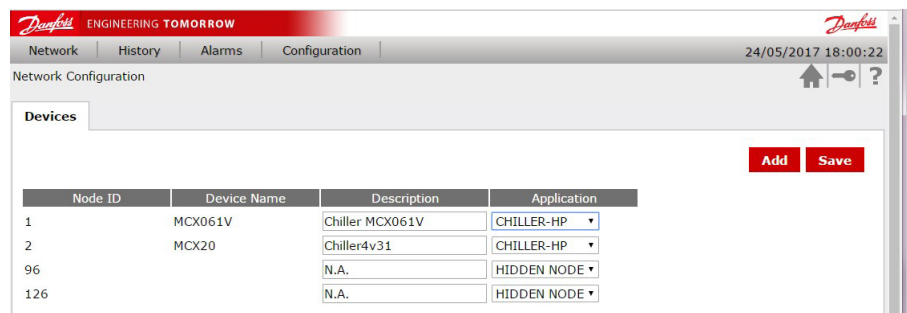

After the *tem* association, in the "Network Overview" page the device status changes from Unconfigured to Active.

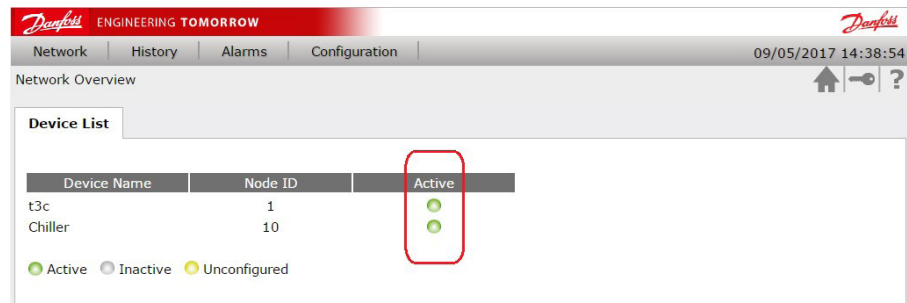

### 5.6.2 Configuration Template & Files

This page is used to load the templates of the software applications running on the MCX061V-MCX152V and other MCX connected to it into the MCX061V-MCX152V. See the next paragraph for how to create a template.

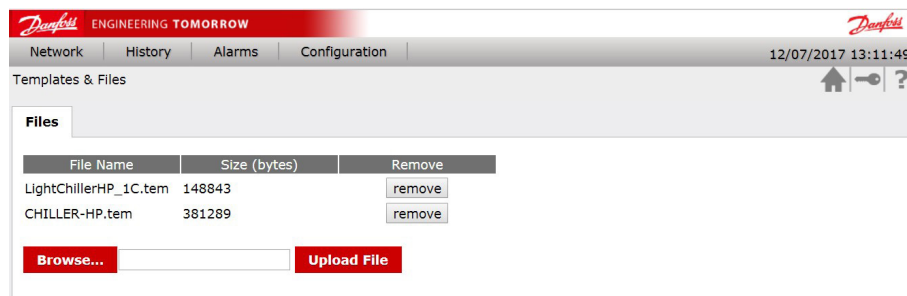

The templates are loaded in the “apps” folder in the MCX. You can also load them here via FTP:

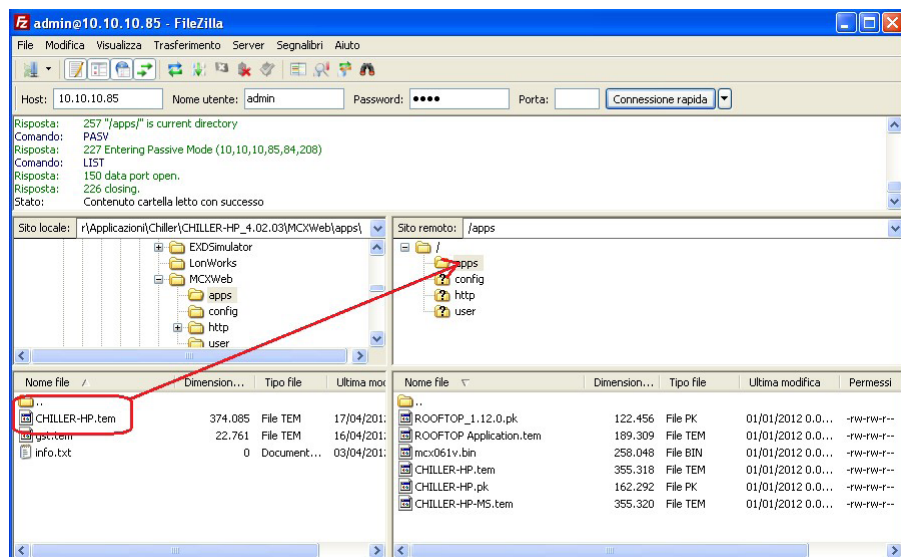

Then the template must be associated to the MCX where the application software described by that template is running (see the previous paragraph).

### 5.6.2.1 Create the application template with MCXShape

Before creating the template, use MCXShape to configure the MCX software application according to your needs. Then enable the generation of the template file from MCXShape. Go into the Tools-Gateway Configuration menu in MCXShape and select the “Enable Saving Web File” check box.

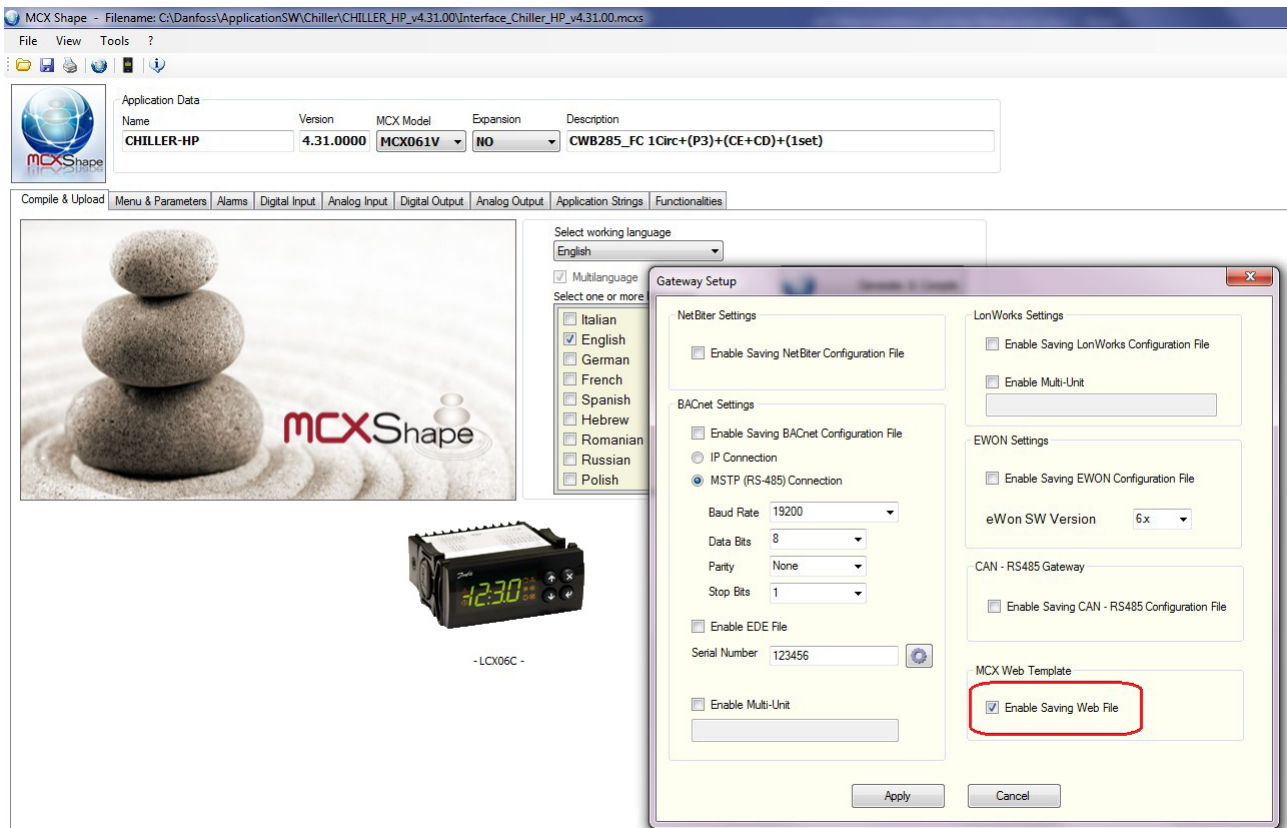

The template file of the MCX software application has the tem extension and it is created during the “Generate and Compile” procedure. The tem file is saved in the folder “MCXWeb\apps\” in the root of the software application.

### 5.6.3 Configuration Users

This lists all the users that can access to the MCXWeb interface. There are four possible levels of access: guest, maintenance, service and admin. These levels correspond to the levels assigned in the device template by the MCXShape tool. Note that you can see only the users with the level equal or lower than the one you logged in.

**Users** [Add](#) [Save](#)

User	Password	E-Mail	Level	Mail Alarm	Mail Warning	Remove
admin	••••	xyz@gmail.com	3 - admin	<input checked="" type="checkbox"/>	<input checked="" type="checkbox"/>	<a href="#">remove</a>
guest	••••		0 - guest	<input type="checkbox"/>	<input type="checkbox"/>	<a href="#">remove</a>

Select the "Mail Alarm" and "Mail Warning" check boxes to send notification emails to the specified addresses when alarms and warnings occurs in any device present in the CANbus network. The destination email address is set in the Email column. See Paragraph 5.6.4.3, Site, on how to set the SMTP mail server.

### 5.6.4 Configuration System

#### 5.6.4.1 Network

This page is used to configure the MCXweb inside the local network to which it belongs. You can manually assign a static IP address (DHCP disabled) or a dynamic address via the dynamic host configuration protocol. If DHCP is enabled, the IP address of the MCXweb device will be automatically assigned by the DHCP server. If the DHCP is not enabled, the network setting (IP Default Gateway, Primary DNS and Secondary DNS) must be manually configured

System Configuration ⬆️ ⬅️ ?

**Network** [NTP](#) [Site](#) [Reboot](#) [Save](#)

DHCP Client	Enable
IP Address	<input type="text"/>
IP Default Gateway	<input type="text"/>
Primary DNS	<input type="text"/>
Secondary DNS	<input type="text"/>
HTTP Port	80

You can also set the HTTP port.

### 5.6.4.2 NTP

Configure the NTP (network time protocol)

Set the NTP server you wish to synchronize with. The MCX061V or MCX152V real time clock will then be synchronized and set according to the defined timezone and daylight saving time.

Daylight Saving Time:

- OFF: deactivated
- ON: activated
- EU: Start=2nd Sunday of March – End=1st Sunday of November
- US: Start=Last Sunday of March – End=Last Sunday of October

**WARNING.** The time synchronization of the MCX connected via CANbus to the MCXWeb is not automatic and must be performed by the application software.

### 5.6.4.3 Site

Set the Site Configuration used when users are notified of alarms and warnings by email. The destination email address is specified when configuring the Users.

Site Name is name of the site used in the alarm email message.

Email Domain is the name of the simple mail transfer protocol (SMTP) server that you want to use.

Email Address is the email address of the sender.

For the Email Port and Mode, refer to the configuration of the SMTP Server.

Unauthenticated and SSL or TLS connections are managed. For each mode, the usual port is automatically proposed but you can manually change it afterwards.

Example of email sent by MCXWeb:

```

Alarm e-mail from Site: TEST
To: Ravazzolo Simone

Notification Type: ALARM START
Site: TEST

Node-Id: 2
Node Description: Chiller4v31
Alarm: Expansion communication fault
Date/Time: 31/5/2017 14:28.54

Please do not reply to this email.
    
```



The Test Email Address is the address to which an email can be sent to test your settings. In the event of a problem you will receive one of the following error codes:

ERROR CODE	DESCRIPTION	ACTION
50	MAIL_FAIL_LOADING_CA_ROOT_CERTIFICATE	Contact Danfoss Product Support
51	MAIL_FAIL_LOADING_CLIENT_CERTIFICATE	Contact Danfoss Product Support
52	MAIL_FAIL_PARSING_KEY	Contact Danfoss Product Support
53	MAIL_FAIL_CONNECTING_SERVER	There is no connection with the mail server. Check the Email Domain and Email Port settings. Also check Network Settings and the physical connection
54	MAIL_FAIL_SSL_CONFIG_DEFAULT	Contact Danfoss Product Support
55	MAIL_FAIL_SSL_CONF_OWN_CERT	Contact Danfoss Product Support
56	MAIL_FAIL_SSL_SETUP	Contact Danfoss Product Support
57	MAIL_FAIL_SSL_SET_HOSTNAME	Contact Danfoss Product Support
58	MAIL_FAIL_HANDSHAKE	Contact Danfoss Product Support
59	MAIL_FAIL_GET_HEADER_FROM_SERVER	Contact Danfoss Product Support
60	MAIL_FAIL_EHLO	Contact Danfoss Product Support
61	MAIL_FAIL_START_TLS	TLS mode is not supported by the mail server. Check the Email Mode setting.
62	MAIL_FAIL_AUTHENTICATION	Authentication failed. Check the Email Address and Email Password settings
63	MAIL_FAIL_WRITING	Authentication was successful, but something went wrong later. Retry. If the problem persists, contact Danfoss Product Support

#### 5.6.4.4 Reboot

Pressing the reboot button restarts the system. This button is normally used after applications (software) and BIOS (firmware) update.

### 5.6.5 Configuration Update

The page is used to upgrade applications (software) and BIOS (firmware)  
 The *application* is the file produced by the MCXShape tool with the *pk* extension; it is executed by the MCX and contains the control strategy and the user interface.  
 The *BIOS* is the firmware pre-installed in the MCX control, so it is the first code run at power on.  
 To proceed with the application and BIOS update, follow these steps:

#### 5.6.5.1 Application Update

Copy the software application file, created with the MCXShape with the *pk* extension, into the MCX061V/MCX152V in one of these two ways (used in alternative):

- 1) From the Configuration->Template & Files menu select the application file and upload it
- 2) Establish the FTP connection with the MCX Web Server as described in paragraph 3 MCXWeb connection. Copy the application file into the folder "apps"

After the file upload, press F5 to refresh the web pages.  
 From the Configuration->Update page, select the Application tab and click with the mouse on the line of the device you want to update.  
 Select from the combo menu which is showing all the *pk* files that you have loaded, the application to download into the device.  
 Confirm the update by pressing the Update button.

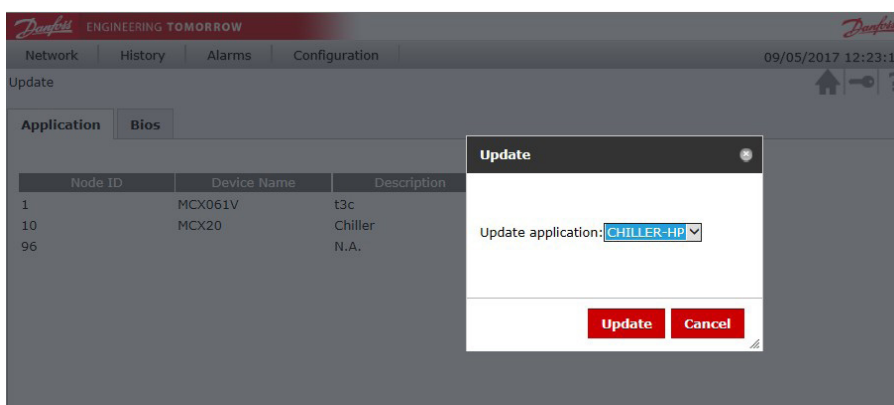

#### 5.6.5.2 BIOS Update

Copy the BIOS file with the *bin* extension into the MCX061V/MCX152V in one of these two ways (used in alternative):

- 1) From the Configuration->Template & Files menu select the BIOS file and upload it
- 2) Establish the FTP connection with the MCX Web Server as described in paragraph 3 MCXWeb connection. Copy the BIOS file into the folder "apps"

After the file upload, press F5 to refresh the web pages.  
 Select the BIOS tab from the Configuration > Update menu and click the line of the device you want to update.

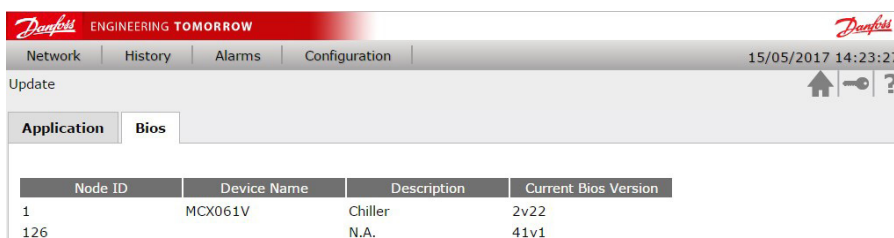

Select the BIOS to be downloaded into the device from the combo menu.  
 Confirm the update by pressing the Update button.  
 If there is the appropriated BIOS (*bin* file) for the MCX model selected in the MCXWeb server app folder, the BIOS update procedure is started, otherwise the "File not found" message will be displayed.

### 5.6.6 Configuration History

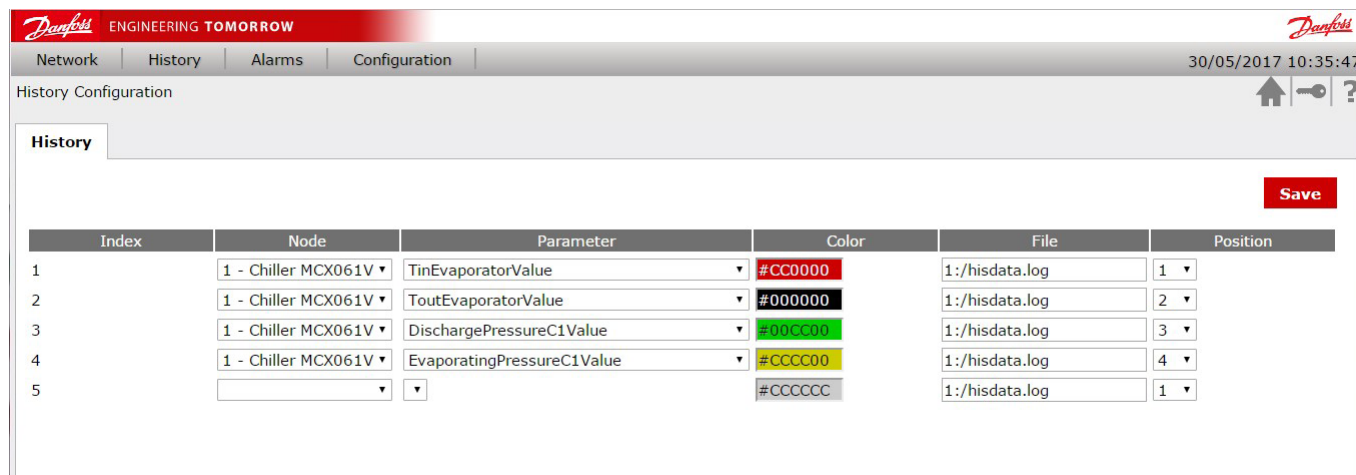

Define the variables to be shown in a graph (max 32) in the History pages. You must define:

- Node to which the variable belongs.  
WARNING. It is possible to plot a graph of data only from the MCX061V or MCX152V where the web server is running, therefore you must select only this node.
- Parameter: variable to view in the History page. All the variables defined in the application software are listed but only the variables saved by application software must be selected. Please refer to the documentation of the specific application software.
- Color: defines the line color (hex code) in the graph in the History page.
- File: defines the file from which the variable value is taken, whether it is stored in the internal memory (0:/) or external memory card (1:/). Please refer to the documentation of the specific application software.
- Position: the position (column) of the variable in the file. Please refer to the documentation of the specific application software.

Example of software developed with MCXDesign:

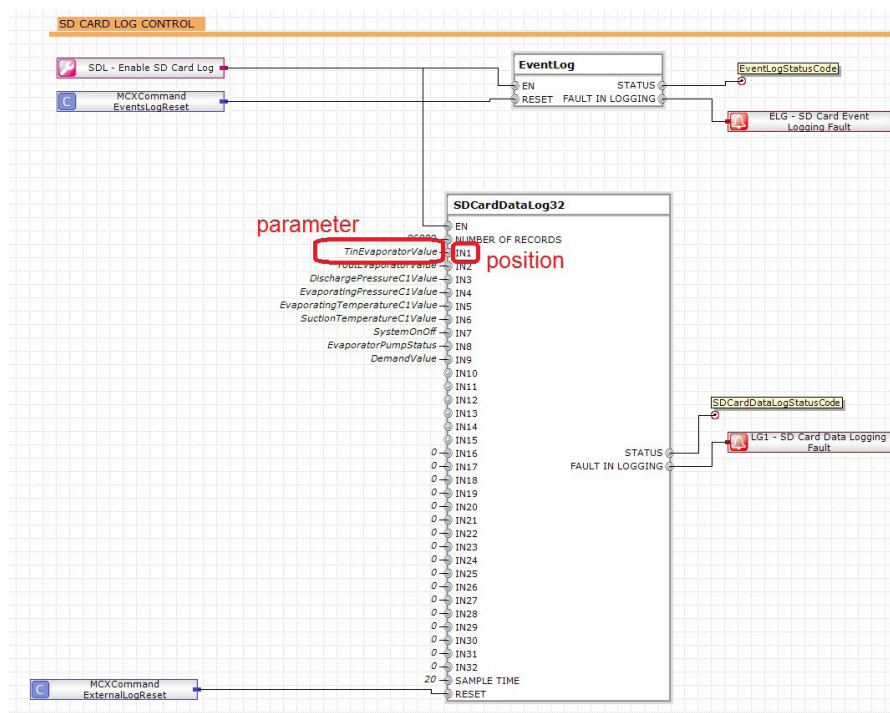

## 5.7 Device Pages

From the home page, if you click on a specific device you will enter the device-specific pages.

### 5.7.1 Device Overview

The overview page is typically used to show the main application data. The default page is empty.

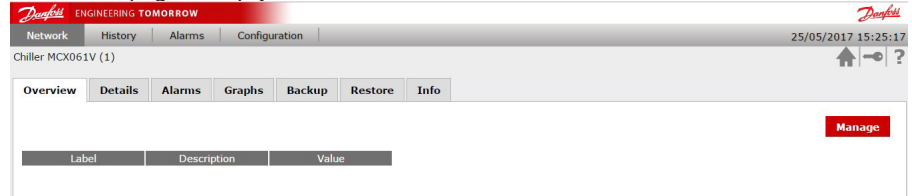

By pressing the Manage button you can select the main parameters to display in this page.

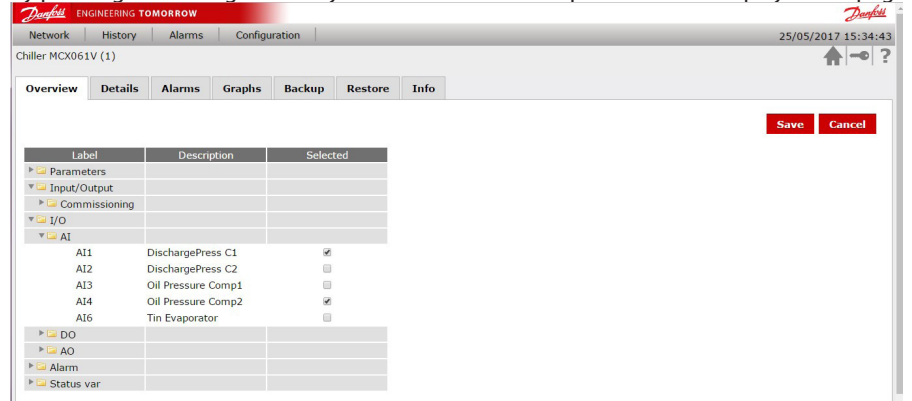

When you have selected all the variables you need, press Save and you will see them on the Overview page



### 5.7.1.1 Customization of the Overview Page

This page can be customized with images and command buttons, by defining the HTML page to be used as interface. The customized HTML page is placed in the /http folder of the MCX061V-MCX152V server. The name is DeviceOverview\_<applicationname>.html where <applicationname> is the name of the application defined in the MCXShape tool.

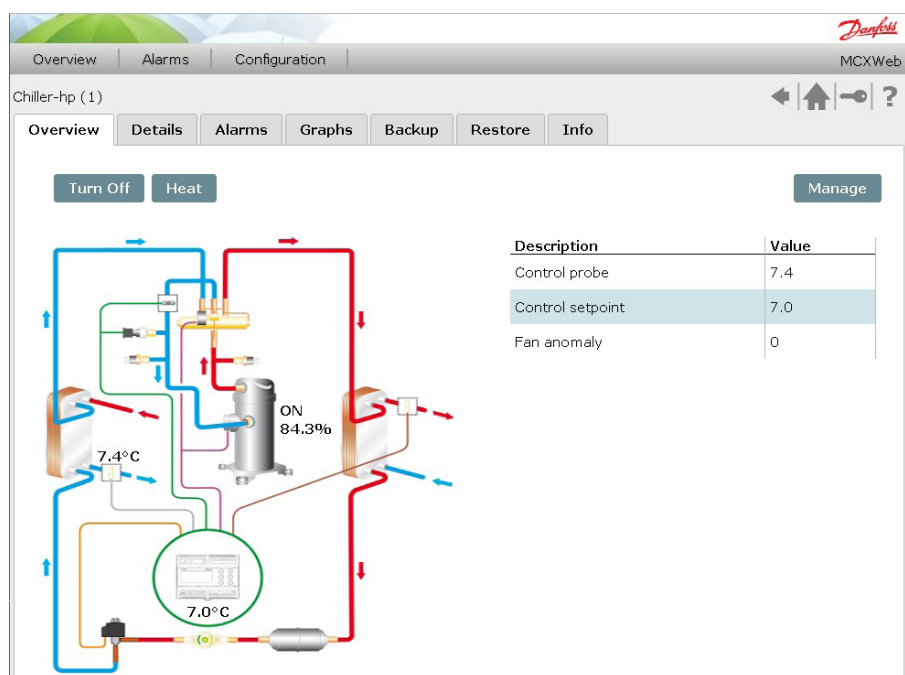
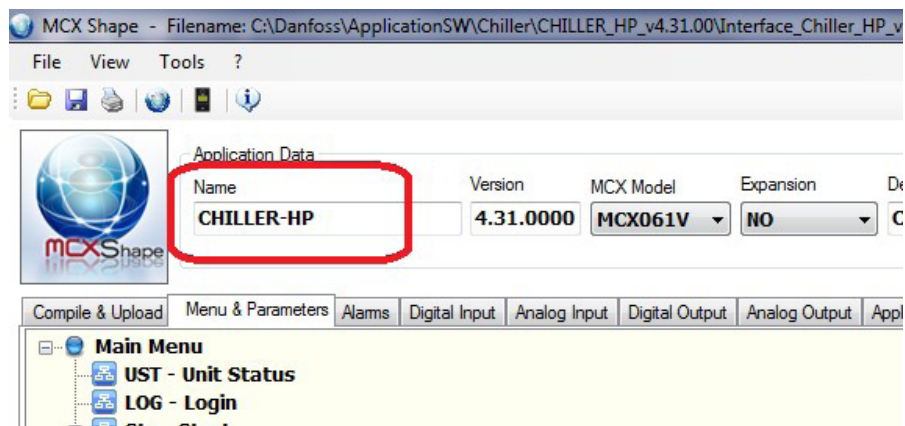

### 5.7.2 Device Details

This page gives you access to the different parameters and variable values by navigating the menu tree.

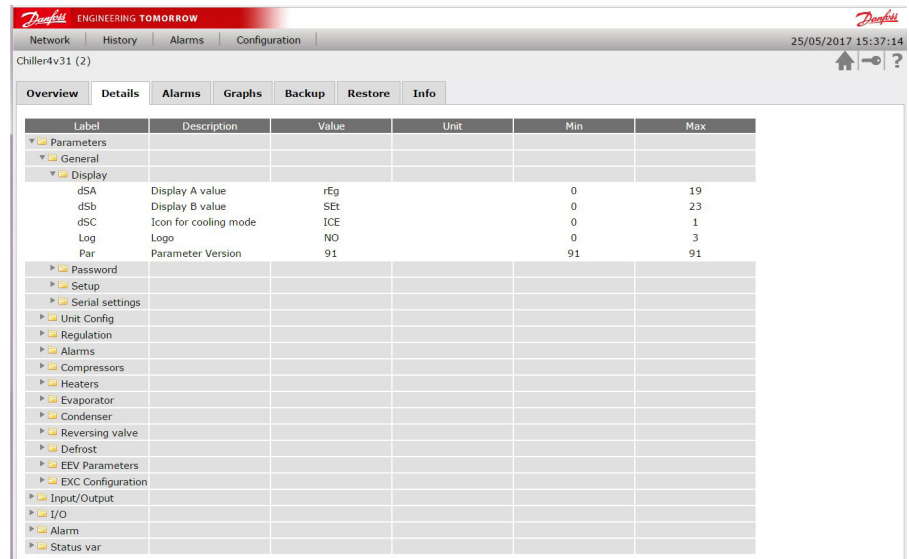

When the parameters are displayed, you can check the current value, the unit of measurement and the minimum and maximum values for each of them. To change the current value of the parameter, click on it.

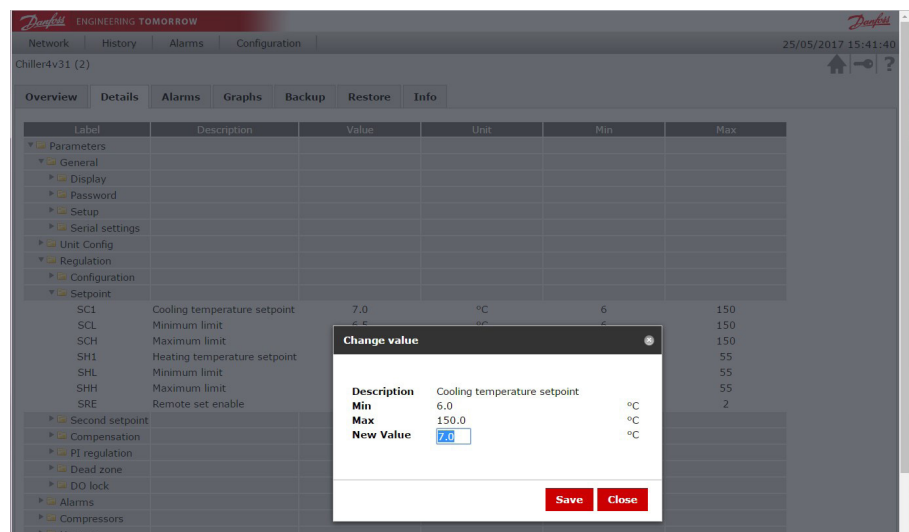

### 5.7.3 Device Alarms

This page displays all the alarms active in the device.

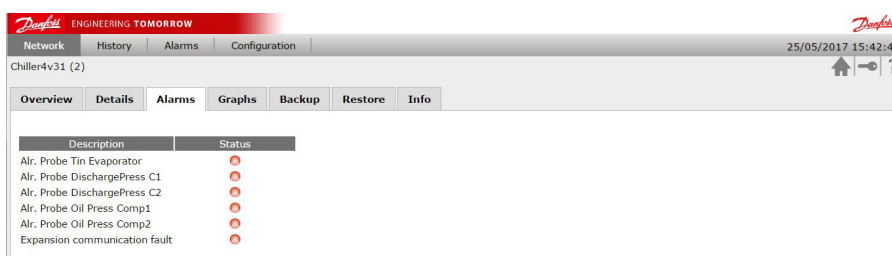

### 5.7.4 Device Graphs

This page lets you select the variables to populate the real-time graph. Press “Change Selected”, navigate the menu tree and select the variable you want to display in a graph.

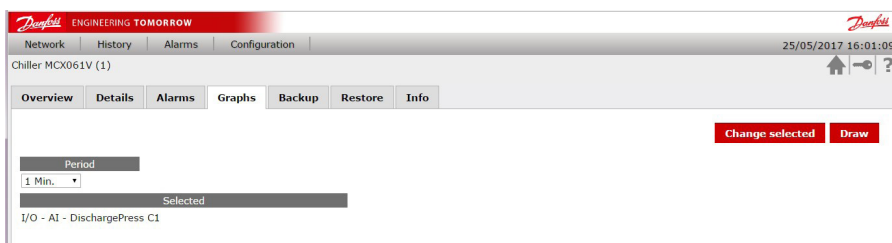

The period to display in the graph window can be configured in the range of 1 to 24 hours.

Once variables and period have been selected, press the Draw button to start plotting the graph using the real-time variables value.

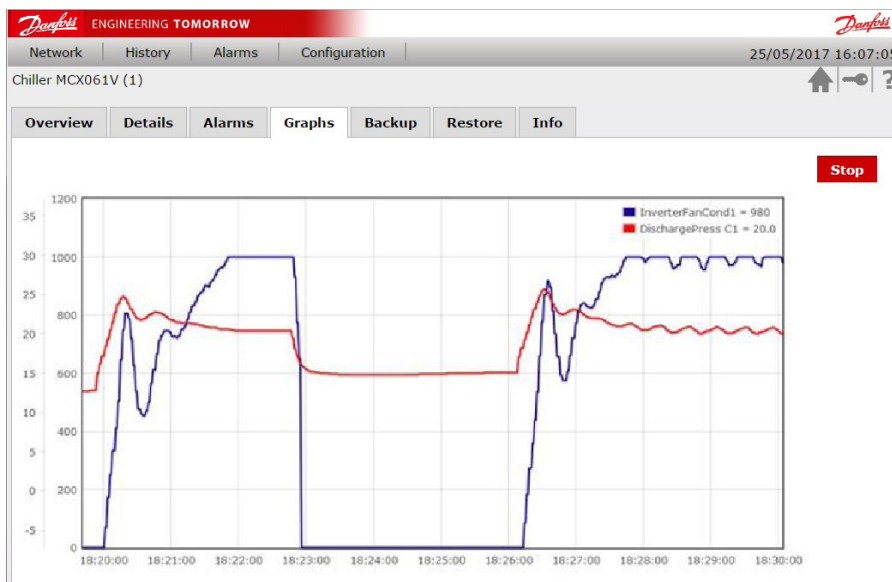

### 5.7.5 Device Backup

This page is used to save the current value of the parameters. It allows you to make a backup of your configuration and to replicate the same configuration in a different device where the same software application is running. The parameters selected in this page (all by default) will be saved into the file specified in a dialog box.

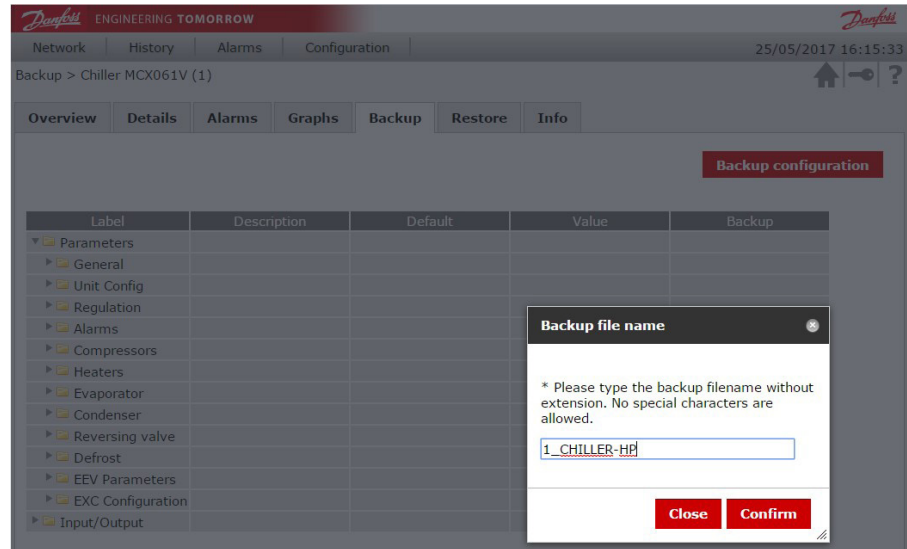

By default, the file name is *ID\_Applicationname.bak*, where *ID* is the address in the CANbus network and *Applicationname* is the name of the application running in the device. The backup file is saved in the /user folder in the MCX061V-MCX152V server.

### 5.7.6 Device Restore

This page contains all the backup files in the \user folder in the MCX061V-MCX152V server.

Only the backup file created with the same application running in the current device will be accepted upon restoring.

To start the restore process of the saved parameters, click the selected backup file.

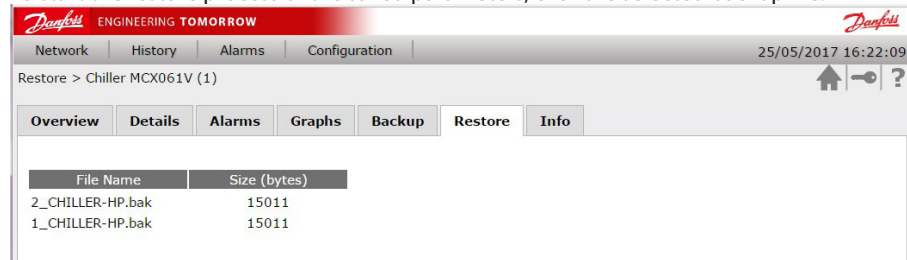

If you select a backup file that is not compatible with the application running in the current device, you will stay in the previous page. Otherwise the following page will appear

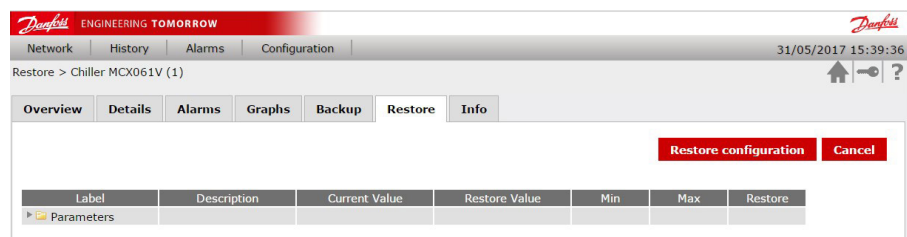



Then deselect the parameters you do not want to restore and press “Restore configuration” to start the process. A pop up window will show you the progress and finally a status report.

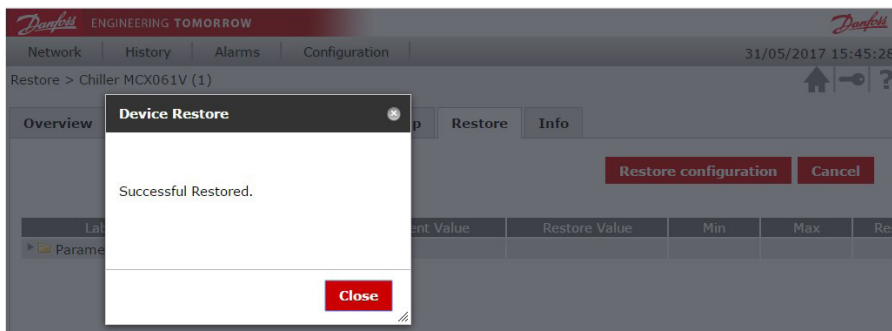

### 5.7.7 Device Info

This page displays the following information relating to the current device:  
 Application name and version  
 BIOS version  
 Serial number of the hardware



## 6. MCXWeb Simulator

You can simulate the web interface of MCX061V-MCX152V with the Simulator in your MCXShape-based software application in the following way:

- Ensure you have the latest MCXWeb folder in the root of your application software:

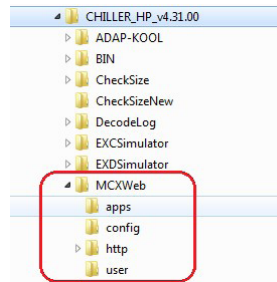

- Enable the generation of the template file from MCXShape. Go into the Tools-Gateway Configuration menu in MCXShape and select the “Enable Saving Web File” check box.

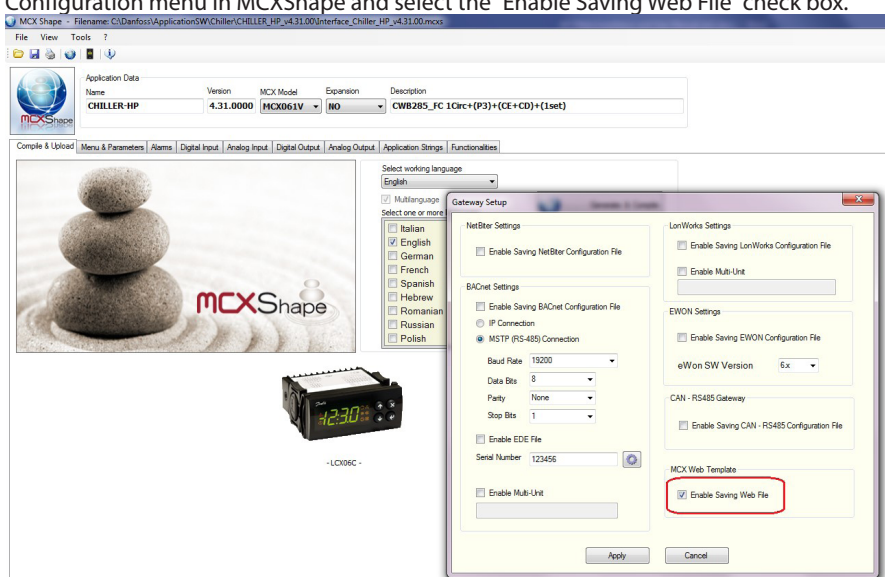

- Generate and compile
- Run the Simulator and press the Configuration button: enable the MCXWeb simulation if not done already.

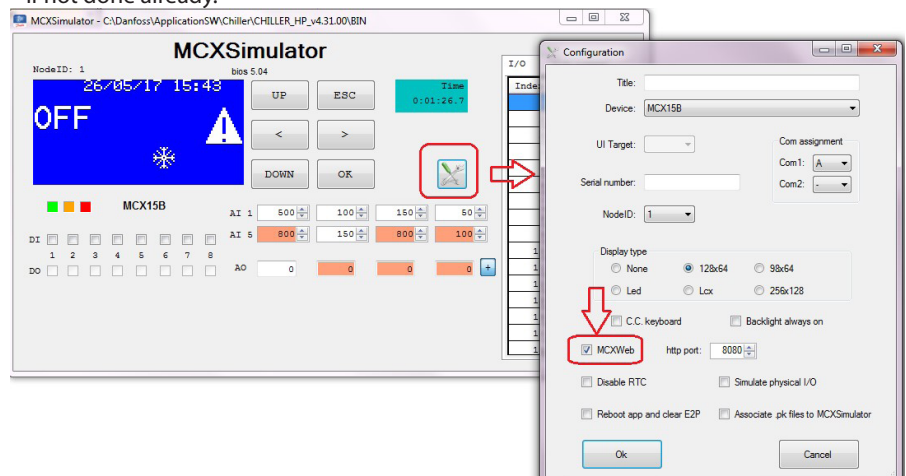

- A Web button will be displayed in the MCXSimulator to start the MCXWeb simulation.

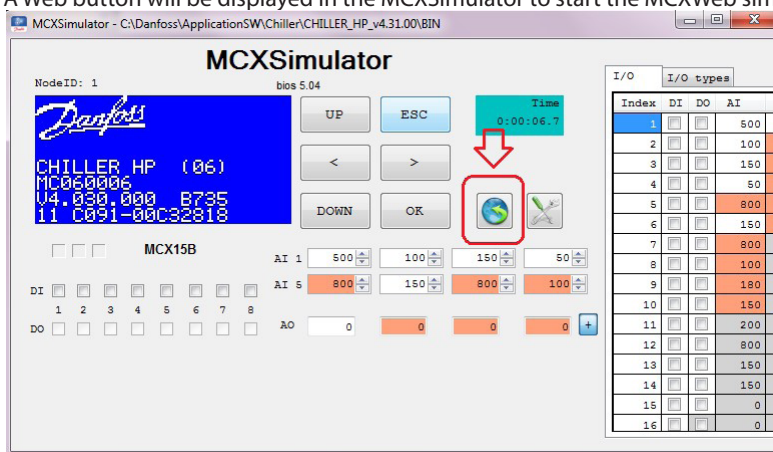

- Press the Web button and the MCXWeb login page will be opened in your default web browser. Insert login (admin) and password (PASS) and you are ready to start. Pages will be populated with data from the simulator.

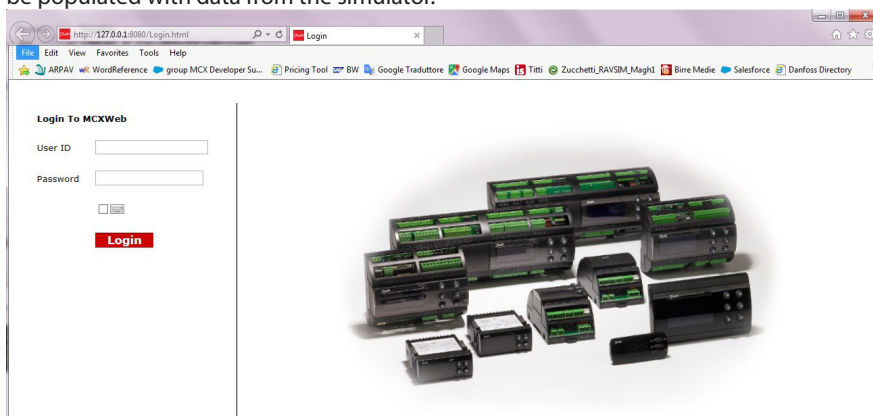

## 7.7 Appendix - Application template XML structure

File name: /app/application\_template\_name.xml

XML structure:

```

<?xml version="1.0" encoding="UTF-8"?>
<Template>
    <VarInfo>
        <AppName></AppName>
        <AppDescr></AppDescr>
        <AppCode></AppCode>
        <AppID></AppID>
        <AppVer></AppVer>
        <TemplateVer></TemplateVer>
    </VarInfo>
<VarList>
    <Var>
        <VarCat></VarCat>
        <VarName></VarName>
        <VarAddr></VarAddr>
        <VarType></VarType>
        <VarLabel></VarLabel>
        <VarDescr></VarDescr>
        <VarBitMask></VarBitMask>
        <VarShift></VarShift>
        <VarScale></VarScale>
        <VarOffset></VarOffset>
        <VarDecimal></VarDecimal>
        <VarMax></VarMax>
        <VarMin></VarMin>
        <VarDefault></VarDefault>
        <VarAccess></VarAccess>
        <VarRW></VarRW>
        <VarVisibility></VarVisibility>
        <VarConstant></VarConstant>
        <VarEnumList><VarEnum>
        </VarEnum></VarEnumList>
        <VarGroupList>
        <VarGroup></VarGroup>
        </VarGroupList>
        <VarAlarmGroup></VarAlarmGroup>
    </Var>
    ....
</VarList>
</Template>
  
```

\* <Var></Var> tag MUST be written in a single row with “\r\n” terminator.

Var tag structure:

Tag	Description	Notes
VarCat	Var category	0 undefined 1 parameter 2 DI /DO 3 alarms 4 status var
VarName	Var identification	
VarAddr	Modbus address	Decimal representation
VarType	Var type	s16 u16 s32 u32
VarLabel	Var label	
VarDescr	Var description	Max 60 chars
VarBitMask	Bitmark filter ( used for packed alarms )	32 bits bitmask
VarShift	Number of right shift to applied after VarBitMask's filter.	
VarScale	Scale to be applied to the value returned from read var request	
VarOffset	Offset to be applied to the value returned from read var request	
VarDecimal	Number of decimals to be applied to the value returned from read var request	
VarMax	Maximum value	
VarMin	Minimum value	
VarDefault	Default value	
VarRW	Read Only / Read-Write	0 read only 1 read write
VarVisibility	Is visible	0 hidde 1 visible
VarConstant	Is constant	0 editable 1 constant
VarEnumList	List of VarEnum tag	VarEnum tags represents the list of descriptions to be applied to the value returned from read var request.
VarGroupList	List of VarGroup tag	VarGroup tag sequence represents the tree structure of groups.
VarAlarm-Group	Alarms group	Identifier of alarms group. The value is considered as bit-mask of 32 alarms.

ENGINEERING  
TOMORROW

*Danfoss*

---

Danfoss can accept no responsibility for possible errors in catalogues, brochures and other printed material. Danfoss reserves the right to alter its products without notice. This also applies to products already on order provided that such alterations can be made without subsequential changes being necessary in specifications already agreed. All trademarks in this material are property of the respective companies. Danfoss and the Danfoss logotype are trademarks of Danfoss A/S. All rights reserved.