

ENGINEERING  
TOMORROW

*Danfoss*

User Guide

# Optyma™ control

## AK-RC 113 three phase



<b>Contents</b>	
	<b>1.0 Introduction</b>
	1.1 General.....3
	<b>2.0 Technical Characteristics</b>
	2.1 Product ID Codes.....3
	2.2 Product Series – Technical Characteristics .....3
	2.3 Overall dimension.....4
	2.4 Identification Data .....4
	2.5 Transport and Storage.....4
	<b>3.0 Functionality</b>
	3.1 Functions managed by the AK-RC 113 electrical panel .....4
	<b>4.0 Installation</b>
	4.1 Standard equipment for assembly and use .....5
	4.2 Mechanical assembly of the panel .....5
	4.3 Electrical wirings .....6
	4.4 Connection of the front panel.....7
	4.5 Pre-use checks.....7
	4.6 Compressor motor circuit breaker calibration .....8
	4.7 Closing the electrical panel.....8
	<b>5.0 Parameter programming</b>
	5.1 Control panel .....9
	5.2 Front keypad.....9
	5.3 LED display .....9
	5.4 General.....10
	5.5 Key to symbols .....10
	5.6 Setting and displaying the set points.....10
	5.7 Level 1 programming (user level).....10
	5.8 List of Level 1 variables (user level).....11
	5.9 Level 2 programming (installer level).....11
	5.10 List of Level 2 variables (installer level) .....11
	5.11 Switching on the AK-RC 113 electronic controller .....14
	5.12 Cold/hot activation/deactivation conditions .....14
	5.13 Manual defrost activation / deactivation .....14
	5.14 Defrost with thermostated resistances .....14
	5.15 Hot gas defrost.....14
	5.16 Pump down function.....14
	5.17 Password function .....14
	<b>6.0 Modbus connection</b>
	6.1 Net configuration with modbus-RTU protocol .....15
	<b>7.0 Diagnostics</b>
	7.1 Diagnostics by means of alarm codes .....15
	7.2 Troubleshooting .....16
	<b>8.0 Maintenance</b>
	8.1 General safety rules .....17
	8.2 Maintenance .....17
	<b>9.0 Appendices</b>
	9.1 AK-RC 113 wiring diagram.....18
	9.2 Part List .....19
	<b>10.0 Ordering</b> .....19

## 1.0 Introduction

### 1.1 General

The OPTYMA™ Control three-phase is a controller for refrigeration systems with a three-phase compressor or for controlling the three-phase evaporating unit only, for complete cold room management. Front access to the automatic fuse and motor protector for the compressor and an innovative design combine to make it the ideal choice for effective refrigeration control.

#### Applications:

- Complete management of three-phase refrigerating systems up to 7.5 HP static or ventilated, with off-cycle or electrical defrosting.

## 2.0 Technical Characteristics

### 2.1 Product ID Codes

Line of electrical panel of OPTYMA™ Control (4 HP):

Code Numbers	
Identification codes	Compressor motor circuit breaker range
080Z3221	4,5 – 6,3 A
080Z3222	7 – 10 A

Line of electrical panel of OPTYMA™ Control (7 HP):

Code Numbers	
Identification codes	Compressor motor circuit breaker range
080Z3226	11 – 16 A
080Z3227	14 – 20 A

### 2.2 Product Series – Technical Characteristics

Technical characteristics	OPTYMA™ Control (4 HP)	OPTYMA™ Control (7.5 HP)
Box dimensions	400 x 300 x 135 mm	400 x 300 x 135 mm
Weight	9 kg	10 kg
Protection rating	IP 65	IP 65
Power supply (3F+N+T)	400 V AC ±10% 50/60Hz	400 V AC ±10% 50/60Hz
Load type	3-phase	3-phase
Operating temperature	- 5 – 40 °C	- 5 – 40 °C
Storage temperature	-25 – 55 °C	-25 – 55 °C
Relative ambient humidity	from 30% to 95% RH w/out condensate	from 30% to 95% RH w/out condensate
Altitude	< 1000 m	< 1000 m
Main switch / general protection	4 poles magnetothermic 16A "D"	4 poles magnetothermic 25A "D"
Interruption power	Icn=6kA / Ics=8kA / Icu=15kA	Icn=6kA / Ics=8kA / Icu=15kA
Compressor protection	Adjustable motor circuit breaker	Adjustable motor circuit breaker
Defrosting	Electrical	Electrical
Status indicators	LED + display	LED + display
Alarm signals	LED + buzzer	LED + buzzer
<b>Inputs</b>		
Ambient probe	NTC 10K 1%	NTC 10K 1%
Evaporator probe	NTC 10K 1%	NTC 10K 1%
Door switch	Present	Present
High/low pressure switch	Present	Present
Kriwan® connection	Present	Present
Compressor functioning mode selection	Pump-down / thermostat	Pump-down / thermostat
<b>Outputs</b>		
Compressor	See motor circuit breaker thermal range relative to panel ID code	See motor circuit breaker thermal range relative to panel ID code
Condenser fans output 1	800 W (1 phase)	800 W total (1 phase)
Condenser fans output 2 (separated)		
Evaporator fans	500 W (1 phase)	2000 W (1phase / 3 phases)
Defrosting heaters	6000 W (AC1) eq. resistive load	9000 W (AC1) eq. resistive load
Room light	800 W (AC1) resistive load	800 W (AC1) resistive load
Solenoid valve	Present	Present
Compressor oil heater	Present	Present
Aux1	100 W	100 W
Aux2	100 W	100 W
Supervision system	Modbus	Modbus

**2.3 Overall dimension**

**2.4 Identification Data**

The device described in this manual is provided on the side of a tag showing its identification data:

- Manufacturer's Name
- Code of the electrical panel
- Serial number (S.N.)
- Power supply
- Compressor range

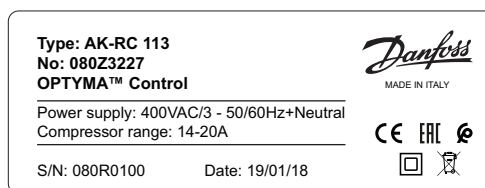
**2.5 Transport and Storage**

Each electrical panel is supplied packed to be shipped without being damaged under normal conditions of transport. In the case of subsequent transport, it must be verified that:

- There are no objects or free parts inside the panel
- The door of the panel is correctly closed and locked
- If the original packaging is not used, adequately protect the product to allow transport without damage.

The storage room must have an adequate temperature and a low humidity value; in addition, avoid that the electrical panel may come into contact with aggressive contaminants, which could compromise its functionality and electrical safety.

**3.0 Functionality**
**3.1 Functions managed by the AK-RC 113 electrical panel**

Signaling with LED icons of the plant status.

Applications:

Complete management of 3 phase static or ventilated refrigeration systems, with off-cycle or electrical defrosting and with direct or pump-down compressor stop.

Main characteristics:

- Cold room temperature displaying and regulation with decimal point.
- Evaporator temperature with decimal point displaying from parameter.
- Plant control activation/deactivation.
- Plant alarms signaling (probe error, minimum and maximum temperature alarm, compressor protection, door alarm).
- LED indicators and large display illustrate system status.
- User-friendly keypad.
- Evaporator fans management.
- Manual and automatic defrost (static, through heaters, through heaters with temperature control, through cycle reversal).
- Direct or pump-down management and control of condensing unit up to 2HP.
- Cold room light activation through key on the panel or through door-switch.
- Direct control of compressor, defrosting elements, evaporator fans, room light with outputs directly connectable to the various units.
- Air recirculation management.
- 2 auxiliary relays with parameter-configured.
- Integrated RS-485 Modbus connection for Danfoss System Manager or standard Modbus-RTU network
- Emergency operation in the event of a faulty probe environment.
- Smart defrost (energy saving).
- Reduced set (night set) from digital input.
- Can be configured for hot or cold applications.
- Configurable digital inputs.

## 4.0 Installation

### 4.1 Standard equipment for assembly and use

The AK-RC 113 electrical panel, for assembly and use, is equipped with:

- Nr 4 sealing gaskets, to be placed between the fixing screw and the back of the box
- Nr 1 use and maintenance manual
- Nr 1 wiring diagram
- Nr 1 drilling layout
- Nr 2 NTC probes 10K 1%

### 4.2 Mechanical assembly of the panel

- Each panel is designed for wall mounting; choose an appropriate fixing system, depending on the weight of the panel and the type of support on which it will be fixed.
- Install the panel in places that respect its IP rating.
- Keep the IP protection level of the appliance intact by properly assembling the cable glands and/or the pipe clamps with appropriate characteristics.
- Install the panel at a height that allows the operator an easy use and internal access. The operator should not come to be in a dangerous situation when he is working on the panel. The height must however be between 0.6 and 1.7 meters from the floor.
- Install the electrical panel in an area away from sources of heat and possibly protected from atmospheric agents.

Following are the steps to perform a correct mechanical installation of the panel:



Fig 1. Lift the transparent protection cover of the general magneto-thermal switch.

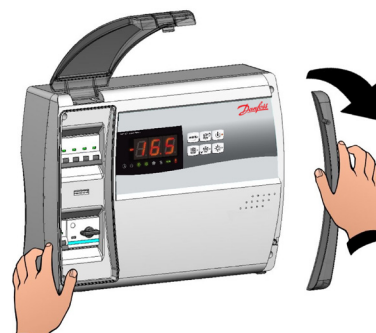

Fig 2. Remove the screw cover on the right side.



Fig 3. Unscrew the 4 fixing screws of the front panel.

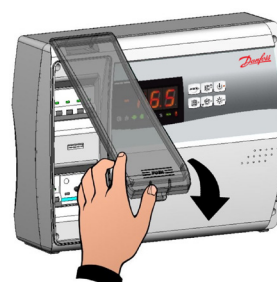

Fig 4. Close the transparent protection cover of the general magnetothermal switch.

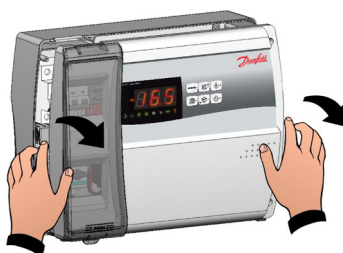

Fig 5. Open the front of the panel by lifting it up and sliding the two black hinges up to the end of the stroke.

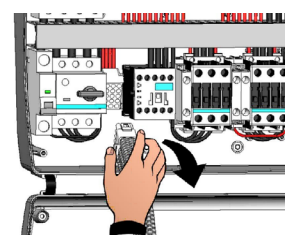

Fig 6. Flex the hinges and rotate the front panel 180° downwards to access the inside of the panel and disconnect the electronic board connector.

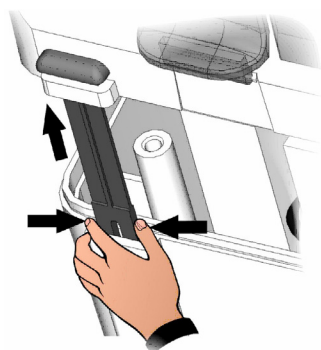

Fig 7. Apply pressure on the sides of each individual hinge to remove it from its seat and completely remove the front panel.

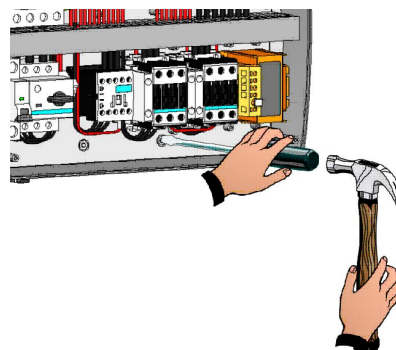

Fig 8. Using a screwdriver, press the four pre-set holes on the back to make the four fixing holes of the electrical panel.

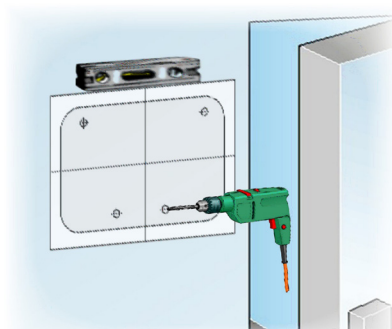

Fig 9. Using the supplied drilling layout, make the four fixing holes on the wall.

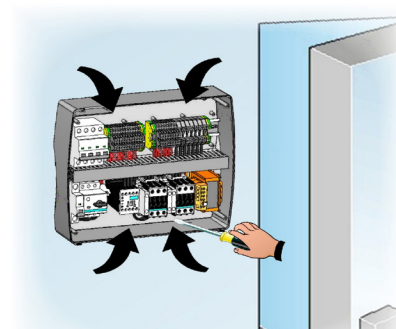

Fig 10. Using the four holes made previously, fix the back of the box using four screws of adequate length in relation to the thickness of the wall. Place a rubber washer (supplied) between each fastening screw and the back of the box.

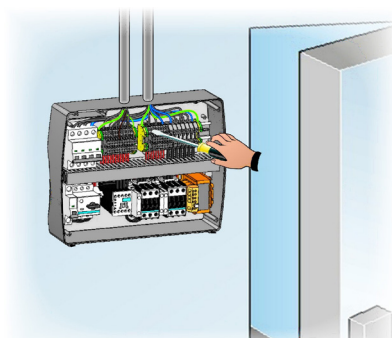

Fig 11. Now make the electrical connections as indicated in the following chapter.

### 4.3 Electrical wirings

- For electrical connections, refer to the specific wiring diagram and to the technical characteristics of the panel model to be installed.
- The power supply to the panel must be carried out exclusively with a dedicated line, upstream of which a device suitable for protection against indirect contacts (differential switch) must be installed.
- Avoid putting power cables and signal cables (probes and digital inputs) in the same conduits (or pipes).
- Avoid using multipolar cables in which there are conductors connected to inductive and power loads and signal conductors such as probes and digital inputs.
- Reduce the lengths of the connecting cables as much as possible, preventing the wiring from taking the spiral shape that is harmful to possible inductive effects on the electronics.
- If it's necessary to extend the probes, conductors must be used with a suitable section and in any case not less than 1 mm<sup>2</sup>.

- For connections to the electrical panel, cables with a section suitable for the current passing through them must be used. The degree of insulation must also be compatible with the applied voltages. Prefer cables with flame retardant insulator and with a low emission of toxic fumes if affected by fire.

It's **mandatory** to connect the clamp marked with the initials **PE** to the ground system of the power supply network. If necessary, check the efficiency of the ground system.

Other conductors with the exception of the external protection conductor must not be connected to the **PE** terminal.

#### 4.4 Connection of the front panel

Re-hook the front panel and reconnect the connector of the electronic board as indicated below.

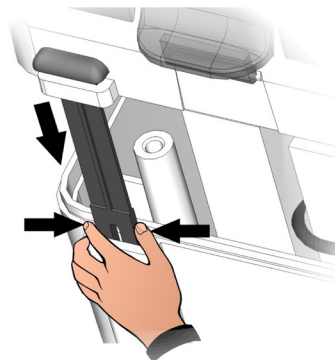

Fig 12. Re-hook the front panel at the back of the box by reinserting the two black hinges in the appropriate seats.

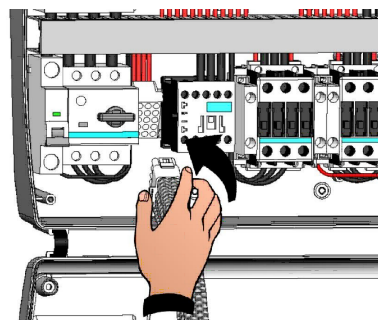

Fig 13. Flex the hinges and rotate the front panel 180° downwards to access the inside of the panel and reconnect the connector of the electronic board.

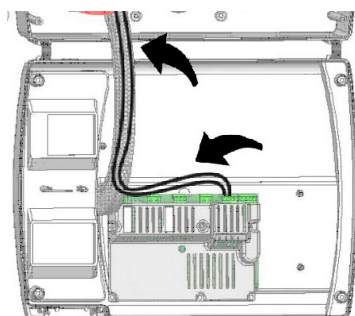

Fig 14. In case panel is connected with Modbus network and/or Alarm/Aux relays are used, wirings must be done directly on the electronic card clamps. It's suggested to put that wirings beside the connection cables from electronic card and bottom of the box. For further clarification on the clamps please refer to the chapter 6.

#### 4.5 Pre-use checks

- After having carried out the wiring, check the correct execution of the same by means of the wiring diagram.
- Make sure that the screws on the clamps are properly tightened. Check, when possible, the correct functioning of external protection devices.
- Make a correct calibration of the motor protection switch (if present) dedicated to the compressor motor, as indicated in the following chapter.
- After turning on the electrical panel, check the correct current absorption of the various loads. After operating the system for a few hours, it is advised to check the correct tightening of the terminal board screws (including the connection of the power supply line).

**Caution:** before carrying out this operation, the panel must be switched off by cutting off the supply line upstream and blocking the sectioning with a padlock to ensure maximum safety. Check the absence of voltage with a Tester before any operation.

4.6 Compressor motor circuit breaker calibration

Below we show step by step how to correctly calibrate motor circuit breaker dedicated to the compressor.

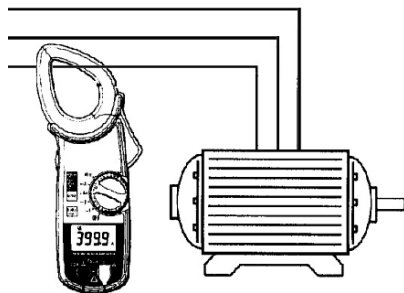

Fig 15. When the system is started for first time it's suggested to calibrate the motor circuit breaker on the compressor power circuits. Using an ammeter verify the effective absorption.

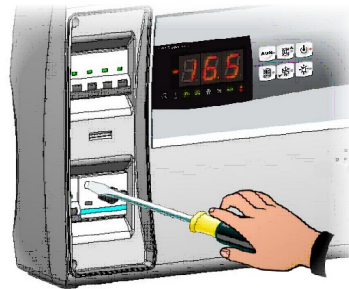

Fig 16. Make the motor circuit breaker calibration basing on the measured absorption. Any way the set up value must not be higher than the one expected by the compressor manufacturer.

**Caution:** incorrect calibration may cause compressor failure or unwanted action of the motor protection switch.

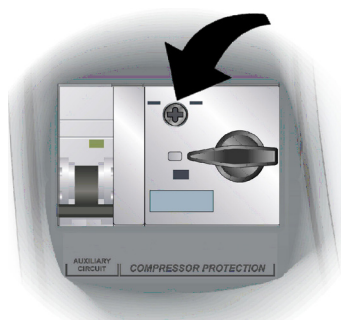

Fig 17. To carry out the calibration, use the adjustment screw on the front of the motor protection switch.

4.7 Closing the electrical panel

Once the electrical connections, checks and calibrations have been completed, the electrical panel can be closed.

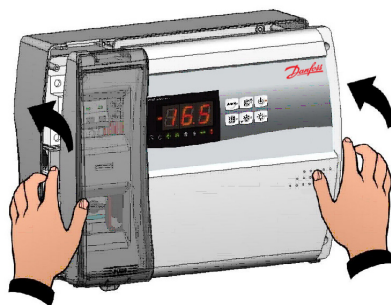

Fig 18. Close the front panel, making sure that all cables are inside the box and that the box gasket is correctly housed.



Fig 19. Tighten the front panel using the 4 screws. Refit the cover of the screws on the right side.

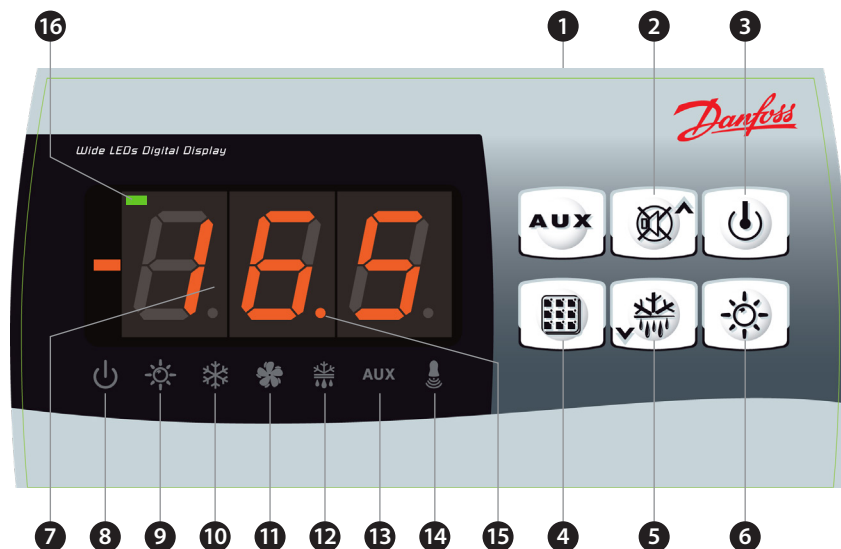

Fig 20. Power up the panel and carry out thorough reading/programming of all the parameters.









## 5.0 Parameter programming





### 5.1 Control panel





### 5.2 Front keypad

- 
**Auxiliary relay control**  
 (controls the relays manual if parameter AU1/AU2 = 2/-2)
- 
**Up/Mute buzzer alarm**
- 
**Stand by** (if the system shuts down the LED flashes)
- 
**Room temperature setting**
- 
**Down/Manual defrost**
- 
**Room light**

### 5.3 LED display

- 
**Cold room temperature parameter / settings**
- 
**Stand-by icon**  
 LED OFF = Electrical panel OFF  
 LED ON = Electrical panel ON and in regulation  
 LED flashing = Electrical panel in stand-by (outputs are disabled)
- 
**Door Switch / Room Light Icon**  
 LED OFF = Door switch disabled or not in use and room light OFF  
 LED ON = Room light ON  
 LED Flashing = Door switch enabled and room light ON
- 
**Cold Call Icon**  
 LED OFF = Cold call OFF  
 LED ON = Cold call ON
- 
**Fan Call Icon**  
 LED OFF = Fan call OFF  
 LED ON = Fan call ON  
 LED Flashing = Fans paused after defrost (see parameter F4)

- 12

**Defrost Call Icon**  
 LED OFF = Defrost call OFF  
 LED ON = Defrost call ON  
 LED Flashing = Dripping phase in progress after defrost (see parameter d7)
- 13

**Auxiliary Relay Icon** (AUX relay call signaling if AU1/AU2 = ± 2 or ± 3)  
 LED OFF = Aux relay call OFF  
 LED ON = Aux relay call ON
- 14

**Alarm Icon**  
 LED OFF = No alarm in progress  
 LED ON = Alarm activated then stopped  
 LED Flashing = Alarm in progress
- 15

**Decimal Point**  
 (flashing in night mode)
- 16

**Hot Mode**  
 (signaling of activation of resistances)

#### 5.4 General

To enhance safety and simplify the operator's work, the AK-RC 113 has two programming levels; the first level (Level 1) is used to configure the frequently-modified SETPOINT parameters. The second programming level (Level 2) is for general parameter programming of the various controller work modes.

It is not possible to access the Level 2 programming directly from Level 1: you must exit the programming mode first.

#### 5.5 Key to symbols

For purposes of practicality the following symbols are used:

(▲) the UP key  is used to increase values and mute the alarm.

(▼) the DOWN key  is used to decrease values and force defrosting.

#### 5.6 Setting and displaying the set points

1. Press the **SET key** to display the current **SETPOINT** (temperature).
2. Hold down the **SET key** and press the (▲) or (▼) keys to modify the **SETPOINT**. Release the **SET key** to return to cold room temperature display: the new setting will be saved automatically.

#### 5.7 Level 1 programming (user level)

To gain access to the Level 1 configuration menu proceed as follows:

1. Press the (▲) and (▼) keys simultaneously and keep them pressed for a few seconds until the first programming variable appears on the display.
2. Release the (▲) and (▼) keys.
3. Select the variable to be modified using the (▲) or (▼) key.
4. When the variable has been selected it is possible:
  - to display the setting by pressing SET key.
  - to modify the setting by pressing the SET key together with the (▲) or (▼) key.

When configuration values have been set you can exit the menu by pressing the (▲) or (▼) keys simultaneously for a few seconds until the cold room temperature reappears.
5. The new settings are saved automatically when you exit the configuration menu.

**5.8 List of Level 1 variables (user level)**

Variables	Meaning	Value	Default
r0	<b>Temperature difference</b> compared to main SETPOINT	0.2 – 10 °C	2 °C
d0	<b>Defrost interval</b> (hours) If d0 = 0 cyclical defrosts Off	0 – 24 hours	4 hours
d2	<b>End-of-defrost setpoint</b> Defrost is not executed if the temperature read by the defrost sensor is greater than d2. (If the sensor is faulty defrost is stopped on time set by the d3 parameter)	-35 – 45 °C	15 °C
d3	<b>Max defrost duration</b> (minutes)	1 – 240 min	25 min
d7	<b>Drip duration</b> (minutes) At the end of defrost the compressor and fans remain at standstill for time d7, the defrost LED on the front panel flashes.	0 – 10 min	0 min
F5	<b>Fan pause</b> after defrost (minutes) Allows fans to be kept at standstill for a time F5 after dripping. This time begins at the end of dripping. If no dripping has been set the fan pause starts directly at the end of defrost.	0 – 10 min	0 min
A1	<b>Minimum temperature alarm</b> Allows user to define a minimum temperature for the room being refrigerated. Below value A1 an alarm trips: the alarm LED flashes, displayed temperature flashes and the buzzer sounds to indicate the problem.	-45 – (A2-1) °C	-45 °C
A2	<b>Maximum temperature alarm</b> Allows user to define a maximum temperature for the room being refrigerated. Above value A2 an alarm trips: the alarm LED flashes, displayed temperature flashes and the buzzer sounds to indicate the problem.	(A1+1) – 99 °C	99 °C
tEu	<b>Evaporator sensor temperature display</b> (displays nothing if dE = 1)	evaporator temperature	read only

**5.9 Level 2 programming (installer level)**

To access the second programming level press the UP (▲) and DOWN (▼) keys and the LIGHT key simultaneously for a few seconds.

When the first programming variable appears the system automatically goes to stand-by.

1. Select the variable to be modified by pressing the UP (▲) and DOWN (▼) keys.  
When the parameter has been selected it is possible to:
  2. View the setting by pressing the SET key.
  3. Modify the setting by holding the SET key down and pressing the (▲) or (▼) key.
  4. When configuration settings have been completed you can exit the menu by pressing the (▲) and (▼) keys simultaneously and keeping them pressed until the room temperature reappears.
  5. Changes are saved automatically when you exit the configuration menu.
  6. Press the STAND-BY key to enable electronic control.

**5.10 List of Level 2 variables (installer level)**

Variables	Meaning	Value	Default
F3	<b>Fan status with compressor off</b>	0 = Fans run continuously 1 = Fans only run when compressor is working 2 = Fans disabled	1
F4	<b>Fan pause during defrosting</b>	0 = Fans run during defrost 1 = Fans do not run during defrost	1
F6	<b>Evaporator fans activation for air recirculation.</b> The fans are activated for a time defined by F7 if they have not started operating for the time F6. If the time of activation coincides with the defrost phase, the defrost end is still awaited.	0 – 240 min 0 = (function not activated)	0 min
F7	<b>Duration of activation of the evaporator fans for air recirculation</b> Fans working time for F6	0 – 240 sec	10 sec
dE	<b>Evaporator probe presence</b> If the evaporator sensor is disabled, defrosts are carried out cyclically with period d0: defrosting ends when an external device trips and closes the remote defrost contact or when time d3 expires.	0 = evaporator sensor present 1 = no evaporator sensor	0

<i>d1</i>	<b>Defrost type:</b> with heater elements, cycle inversion (hot gas) or with thermostatic resistance. <b>Warning:</b> do not set d1=1 in this type of panel; see Section 5.15.	0 = element 1 = hot gas (see section 5.15) 2 = with thermostatic resistance	0
<i>dPo</i>	<b>Defrost at Power On</b>	0 = disabled 1 = defrost at power-on (if possible)	0
<i>dSE</i>	<b>Smart defrost</b>	0 = disabled 1 = enabled	0
<i>dSt</i>	<b>Smart defrost Setpoint (if dSE=1)</b> The count of the time between defrosts is increased only if the compressor is on and the evaporator temperature is lower than dSt.	-30 – 30 °C	1 °C
<i>dFd</i>	<b>Display during defrost</b>	0 = current temperature 1 = room temperature at the beginning of the defrost 2 = "DEF"	1
<i>Ad</i>	<b>Modbus Network address</b>	0 – 247	0
<i>Bdr</i>	<b>Modbus baudrate</b>	0 = 300 baud 1 = 600 baud 2 = 1200 baud 3 = 2400 baud 4 = 4800 baud 5 = 9600 baud 6 = 14400 baud 7 = 19200 baud 8 = 38400 baud	8
<i>Prt</i>	<b>Modbus parity check</b>	0 = none 1 = even 2 = odd	1
<i>Ald</i>	<b>Minimum and maximum temperature signalling and alarm display delay</b>	0 – 240 min	120 min
<i>C1</i>	<b>Minimum time between shutdown and subsequent switching on of the compressor.</b>	0 – 15 min	0 min
<i>CAL</i>	<b>Cold room sensor value correction</b>	-10 – 10 °C	0 °C
<i>CE1</i>	<b>Compressor ON operating time in the event of a faulty ambient probe.</b> (emergency operation). With CE1=0 the emergency operation in the presence of error E0 remains disabled, the compressor remains off and defrosts are inhibited to preserve the residual cold.	0 – 240 min 0 = disabled	0 min
<i>CE2</i>	<b>Compressor OFF operating time in the event of a faulty ambient probe.</b>	5 – 240 min	5 min
<i>doC</i>	<b>Compressor safety time for door switch:</b> when the door is opened the evaporator fans shut down and the compressor will continue working for time doC, after which it will shut down.	0 – 5 min	0 min
<i>tdo</i>	<b>Compressor restart time after door opening.</b> when the door is opened and after tdo time, it's setted back the normal functioning giving door open alarm (Ed) If the door switch is closed and the light stays on for a longer time than tdo light cell alarm is signaled (E9). With tdo=0 the parameter is disabled.	0 – 240 min 0 = disabled	0 min
<i>Fst</i>	<b>FAN shutdown TEMPERATURE</b> The fans will stop if the temperature value read by the evaporator sensor is higher than this value.	-45 – 99 °C	99 °C
<i>Fd</i>	<b>Fst differential</b>	1 – 10 °C	2 °C
<i>LSE</i>	<b>Minimum value attributable to setpoint.</b>	-45 – (HSE-1) °C	-45 °C
<i>HSE</i>	<b>Maximum value attributable to setpoint.</b>	(LSE+1) – 99 °C	99 °C

<i>AU1</i>	<b>Auxiliary/alarm relay 1 control</b>	<p>-6 (NC) = relay de-energised during stand-by</p> <p>-5 (NC) = Contact for casing element control (AUX relay closed with compressor output inactive).</p> <p>-4 (NC) = pump down function (NC, see CHAP 5.16)</p> <p>-3 (NC) = automatic auxiliary relay managed by StA temp. setting with 2°C differential (NC)</p> <p>-2 (NC) = manual auxiliary relay controlled via AUX key (NC)</p> <p>-1 (NC) = alarm relay (NC)</p> <p>0 = relay deactivated</p> <p>1 (NO) = alarm relay (NO)</p> <p>2 (NO) = manual auxiliary relay controlled via AUX key (NO)</p> <p>3 (NO) = automatic auxiliary relay managed by StA temp. setting with 2°C differential (NO)</p> <p>4 (NO) = pump down function (NO, see CHAP 5.16)</p> <p>5 (NO) = free voltage contact for condensing unit (AUX relay and compressor relay in parallel)</p> <p>6 (NO) = relay excited during stand-by</p>	-1
<i>AU2</i>	<b>Auxiliary/alarm relay 2 control</b>	(like AU1 )	5
<i>StA</i>	<b>Temperature setting for auxiliary relay</b>	-45 – 45 °C	0 °C
<i>nSC</i>	<b>Correction factor for the SET button during night operation</b> (energy saving) (with In1 or In2 = 8 or -8) During night operation the control set is: Set Control = Set + nSC In night mode decimal point flashes.	-20 – 20 °C	0 °C
<i>In1</i>	<b>INP-1 input setting</b>	<p>8 = Night mode digital input (energy saving, N.O.)</p> <p>7 = Stop defrosting remotely (N.O.) (reads rising edge of impulse)</p> <p>6 = Start defrosting remotely (N.O.) (reads rising edge of impulse)</p> <p>5 = Stand-by remotely (N.O.) (In order to indicate Stand-By mode, the display shows 'In5' alternating with the current view)</p> <p>4 = Pump-down pressure switch (N.O.)</p> <p>3 = Man-in-room alarm (N.O.)</p> <p>2 = Compressor protection (N.O.)</p> <p>1 = Door switch (N.O.)</p> <p>0 = disabled</p> <p>-1 = Door switch (N.C.)</p> <p>-2 = Compressor protection (N.C.)</p> <p>-3 = Man-in-room alarm (N.C.)</p> <p>-4 = Pump-down pressure switch (N.C.)</p> <p>-5 = Stand-by remotely (N.C.) (In order to indicate Stand-By mode, the display shows 'In5' alternating with the current view)</p> <p>-6 = Start defrosting remotely (N.C.) (reads falling edge of impulse)</p> <p>-7 = Stop defrosting remotely (N.C.) (reads falling edge of impulse)</p> <p>-8 = Night mode digital input (energy saving, N.C.)</p>	2

In2	INP-2 input setting	(like In1)	1
bEE	Buzzer enable	0 = disabled 1 = enabled	1
mOd	Operating mode Thermoregulator	0 = Cold call 1 = Hot call (with mOd=1 the defrosts and the fan block Fst are excluded)	0
P1	Password type of protection (active when PA is not equal 0)	0 = only display set point 1 = display set point, AUX, light access 2 = access in programming not permitted 3 = access in second level programming not permitted	3
PA	Password (see P1 for the type of protection)	0...999 0 = not active	0
reL	Software release	indicates software version	2 (read only)

### 5.11 Switching on the AK-RC 113 electronic controller

After completing the wiring of the electrical panel, power it by operating the main switch; immediately the electrical panel will emit a sound for a few seconds and at the same time all the LEDs will light up on the display.

### 5.12 Cold/hot activation/deactivation conditions

**In cold mode (mOd=0)**, the AK-RC 113 controller activates the compressor when cold room temperature exceeds setting + differential (r0); it deactivates the compressor when cold room temperature is lower than the setting.

If Pump-Down function is selected (parameter AU1/AU2 = 4/-4), see chapter 5.16 for compressor activation/deactivation conditions.

**In hot mode (mOd=1)**, the AK-RC 113 controller activates the heat output (COMPR output) when cold room temperature drops below setting-differential (r0); it deactivates the heat output (COMPR output) when cold room temperature is higher than the setting.

### 5.13 Manual defrost activation /deactivation

To activate the defrost, simply press the dedicated key (see Chapter 5.2) in this way the resistance relay is activated. Defrost is not activated if the set end defrost temperature (d2) is lower than the temperature detected by the evaporator probe. Defrost will end when the end defrost temperature (d2) is reached or for maximum defrost duration (d3) or for manual defrosting end forcing (defrost end button or digital input).

### 5.14 Defrost with thermostated resistances

Set the parameter **d1=2** for the management of the resistance defrost with time limit. During defrosting, the defrost relay is activated if the temperature read by the defrost probe is less than **d2**. The defrost phase lasts **d3** minutes, regardless of the state of the relay. This allows a better defrosting of the evaporator with a consequent energy saving.

### 5.15 Hot gas defrost

**Warning: do not set d1 = 1 in this type of electrical panel.**

The hot gas defrost is not available for this type of electrical panel.

### 5.16 Pump down function

Selection of PUMP DOWN functioning mode for the compressor working on X1 terminal block, changing the selection connection as indicated in the wiring diagram.

**Warning:** Parameters AU1 / AU2 must never be set to 4 / -4 because the PUMP DOWN function is made in electromechanical inside the electrical panel.

### 5.17 Password function

When parameter PA is setting with value different to 0 the protection function is activated. See parameter P1 for the different protection.

When PA is setting the protection start after two minutes of inactivity. On display appear 000.

With up/down modify the number, with set key confirm it.

Use universal number 100 if you don't remember the password.

## 6.0 Modbus connection

### 6.1 Net configuration with modbus-RTU protocol

For RS-485 connections with Modbus-RTU protocol follow the scheme below.

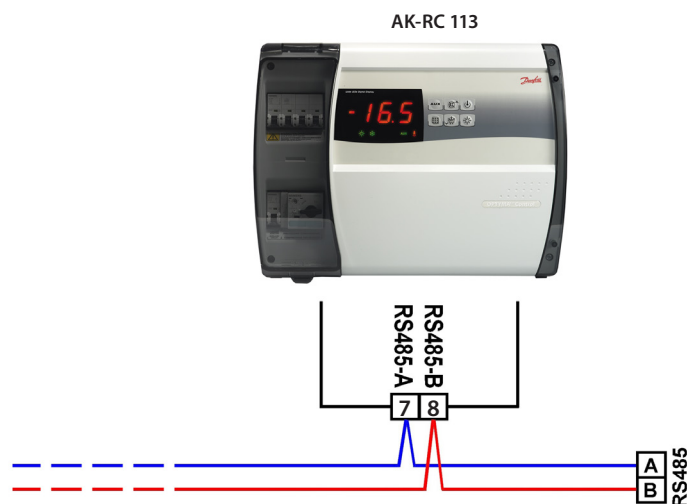

## 7.0 Diagnostics



### 7.1 Diagnostics by means of alarm codes

In the event of any anomalies of the AK-RC 113, it notifies the operator by means of the alarm codes displayed on the display and an audible signal emitted by a buzzer inside the control panel. The EL and EH temperature alarms remain visible even after their return (alarm icon lights on) until their acknowledgment (by pressing the key). If an alarm condition occurs, one of the following messages will be displayed on the display:

Alarm code	Possible cause	Solution
E0	Cold room temperature sensor not working properly	<ul style="list-style-type: none"> <li>Check that cold room temperature sensor is working properly</li> <li>If the problem persists, replace the sensor</li> </ul>
E1	Defrost sensor not working properly (In this case defrosts will last time d3)	<ul style="list-style-type: none"> <li>Check that defrost sensor is working properly</li> <li>If the problems persists, replace the sensor</li> </ul>
E2	Eeprom alarm An EEPROM memory alarm has been detected (All outputs except the alarm one are deactivated)	<ul style="list-style-type: none"> <li>Switch unit off and back on</li> </ul>
E8	Man in cold room alarm	<ul style="list-style-type: none"> <li>Reset the alarm input inside the cold room</li> </ul>
Ec	Compressor protection tripped (e.g. thermal protection or max pressure switch) (All outputs except the alarm one – where applicable – are deactivated)	<ul style="list-style-type: none"> <li>Check that compressor is working properly</li> <li>Check compressor absorption</li> <li>If the problem persists, contact the technical assistance service</li> </ul>
Ed	Open door Alarm. When the door is opened and after tdo time, it's settled back the normal functioning giving door open alarm (Ed).	<ul style="list-style-type: none"> <li>Check door switch status</li> <li>Check door switch connections</li> <li>If the problem persists contact the technical assistance service</li> </ul>
E9	Cell light alarm. The light of the cell has been on for a time greater than tdo.	<ul style="list-style-type: none"> <li>Turn off the light</li> </ul>
EH	Maximum temperature alarm. The temperature inside the cold room has exceeded the max. temperature alarm setting (see variables A2, user programming level)	<ul style="list-style-type: none"> <li>Check that the compressor is working properly.</li> <li>Sensor not reading temperature properly or compressor start/stop control not working.</li> </ul>
EL	Minimum temperature alarm. The temperature inside the cold room has exceeded the min. temperature alarm setting (see variables A1, user programming level).	<ul style="list-style-type: none"> <li>Check that the compressor is working properly.</li> <li>Sensor not reading temperature properly or compressor start/stop control not working.</li> </ul>

**7.2 Troubleshooting**

If there is not an alarm code, we list below some of the most common causes that can cause anomalies. These causes can be due to problems internal or external to the electrical panel.

Event	Possible cause	Operation to be performed
The compressor doesn't start Display is OFF	Absence of power supply.	<ul style="list-style-type: none"> <li>• Check that the display on the panel and the plant in operation green light  are on.</li> <li>• Check the connections of the ambient probe.</li> <li>• If the problem persists replace the sensor.</li> </ul>
	Intervention of the general protection circuit breaker.	<ul style="list-style-type: none"> <li>• Before reinserting the circuit breaker, check that there are no short circuits. Then reinsert the circuit breaker checking all the absorptions to identify any anomalies.</li> </ul>
	Intervention of the circuit breaker of the auxiliary circuits.	<ul style="list-style-type: none"> <li>• Before reinserting the circuit breaker, check that there are no short circuits. Then reinsert the circuit breaker checking all the absorptions to identify any anomalies.</li> </ul>
	Intervention of the secondary circuit protection fuse on the transformer.	<ul style="list-style-type: none"> <li>• Restore the fuse (Glass fuse 10x20 F250mA 250V).</li> <li>• Check that the absorption on the secondary of the transformer does not exceed 0.25A.</li> <li>• Check that no other users have been connected to the Kriwan power supply terminals.</li> <li>• Check that there are no short circuits on the secondary circuit.</li> </ul>
The compressor doesn't start	The panel is in stand-by.	<ul style="list-style-type: none"> <li>• Verify that the panel is not in standby mode (flashing  green light). In this case, press the key to reactivate the panel (green light  on steady).</li> </ul>
	Intervention or anomaly of pressure switches or kriwan.	<ul style="list-style-type: none"> <li>• Check the electrical connections, the calibrations and the correct functioning of the sensors and the compressor.</li> <li>• If it is the first ignition, check the presence of the "PumpDown / Thermostat" operating mode selection bridge on terminal board X1 and jumper the consent terminals of the devices not present in the system (Pressure Switches, Kriwan)</li> </ul>
The defrost cycle is not performed	Incorrect setting of the parameters relating to the defrost cycle	<ul style="list-style-type: none"> <li>• Check the correct entry of the parameters.</li> </ul>



## 8.0 Maintenance

### 8.1 General safety rules

Whatever the nature of the maintenance, it must be performed exclusively by specialized technical personnel.



In the event of a fault or maintenance to the electrical system, before proceeding with any checks, the panel must be disconnected from the mains power switch in the open position (O). Check the absence of voltage with a Tester before any operation. Each element of the electrical panel, if it proves to be faulty, must be replaced only with original parts.

If maintenance involves parts outside the panel, perform the following steps:

- Securely and safely isolate the panel power supply in one of the following ways:
  - Turn the AK-RC 113 main switch OFF and padlock the front cover.
  - Isolate the power supply upstream of our panel permanently, by tapping it to OFF.
- Put signals to indicate that the machine is under maintenance.

Before proceeding with maintenance operations, carry out the following safety instructions:



- The electrical panel must be disconnected from the power supply.
- Prevent unauthorized personnel from being present in the intervention area.
- Put signals to indicate that the machine is under maintenance.
- Wear work clothes (suits, gloves, shoes, headgear) suitable and free of free appendages.
- Remove, if worn, any object that can get caught in protruding parts of the electrical panel.
- Have accident prevention equipment and tools suitable for operations.
- Tools must be clean and degreased.
- Have available the technical documentation necessary to perform the maintenance intervention (wiring diagrams, tables, drawings, etc.).
- At the end of the maintenance operations, remove all the residual materials and carefully clean the panel.

**NOTE:** It's absolutely forbidden to accommodate additional parts inside the panel.

The manufacturer declines every responsibility if the points in this chapter are not observed.

### 8.2 Maintenance

Scheduled maintenance is necessary to guarantee the functionality of the electrical panel over time and to prevent the deterioration of some elements from being a source of danger for people. It must only be carried out by specialized technical personnel and in compliance with the general safety regulations.

Device	Type of intervention	Frequency
Terminal block	Wires tightening	After first 20 days of functioning
Terminal block	Wires tightening	Annual

9.0 Appendices

9.1 AK-RC 113 wiring diagram

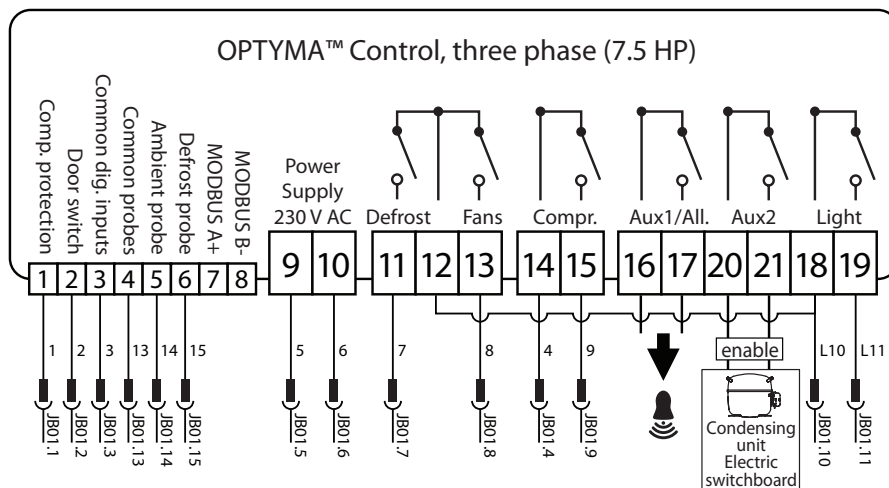
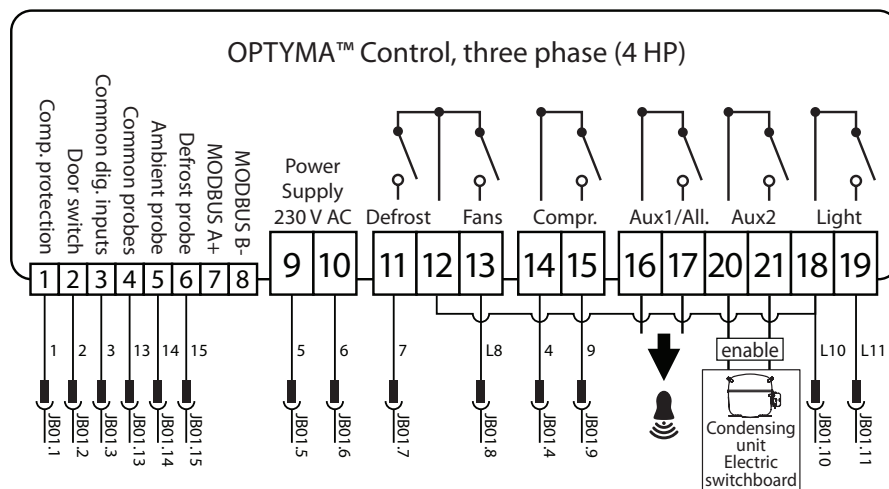

9.2 Part List

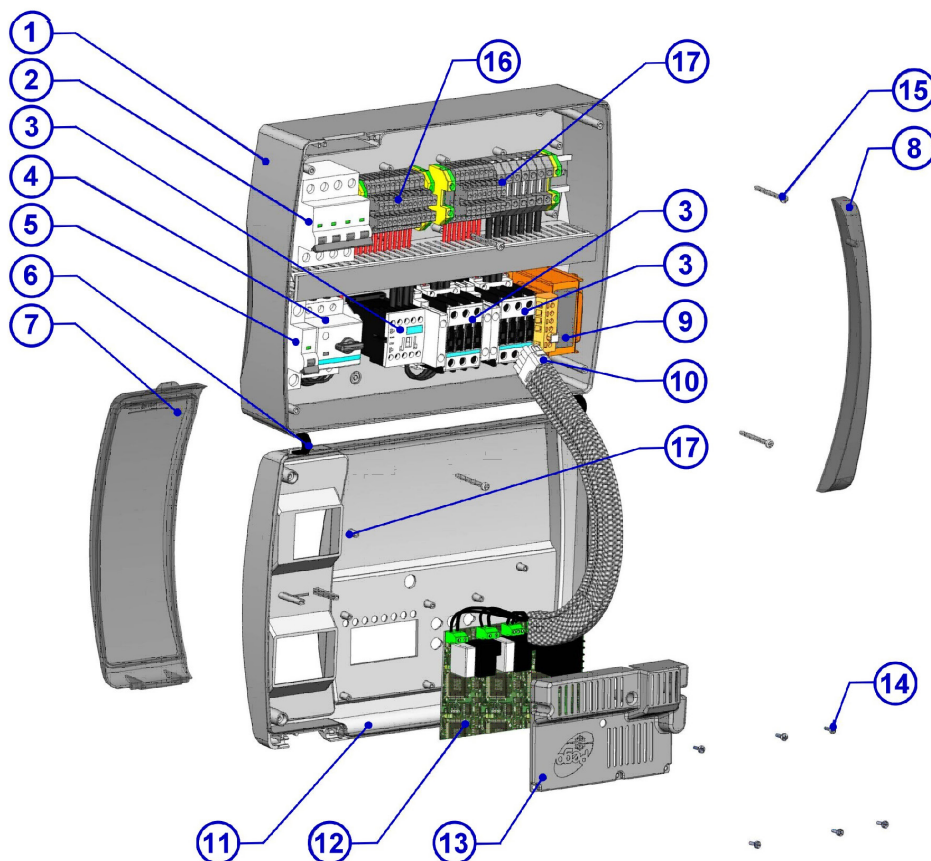

Key	
Ref.	Description
1.	Box rear in Abs
2.	4 poles magnetothermic circuit breaker with general switch / general protection function
3.	Contactors for units control
4.	Compressor protection motor circuit breaker
5.	Auxiliary protection 1-pole magnetothermic circuit breaker
6.	Box front opening hinges
7.	Front cover in transparent polycarbonate
8.	Transparent polycarbonate screw cover
9.	Auxiliary circuits transformer (N.B. with inside a glass fuse 10 x 20 F250 mA 250 V)
10.	Connector for linking panel and the electronic card
11.	Front panel
12.	Electronic card
13.	Electronic card cover
14.	Electronic card fixing screws
15.	Box closure screws
16.	Auxiliary terminal block X1
17.	Power terminal block X2

10.0 Ordering

Type	Code No.
Optyma Control, three phase (4HP), including 2 sensors, 4.5 – 6.3 A	080Z3221
Optyma Control, three phase (4HP), including 2 sensors, 7 – 10 A	080Z3222
Optyma Control, three phase, (7.5HP), including 2 sensors, 11 – 16 A	080Z3226
Optyma Control, three phase, (7.5HP), including 2 sensors, 14 – 20 A	080Z3227
Sensor EKS 221 (spare part)	084N3210

ENGINEERING  
TOMORROW



---

Danfoss can accept no responsibility for possible errors in catalogues, brochures and other printed material. Danfoss reserves the right to alter its products without notice. This also applies to products already on order provided that such alterations can be made without subsequential changes being necessary in specifications already agreed. All trademarks in this material are property of the respective companies. Danfoss and the Danfoss logotype are trademarks of Danfoss A/S. All rights reserved.

---