

User Guide

Capacity controller for dry cooler AK-PC 420

ADAP-KOOL® Refrigeration control systems

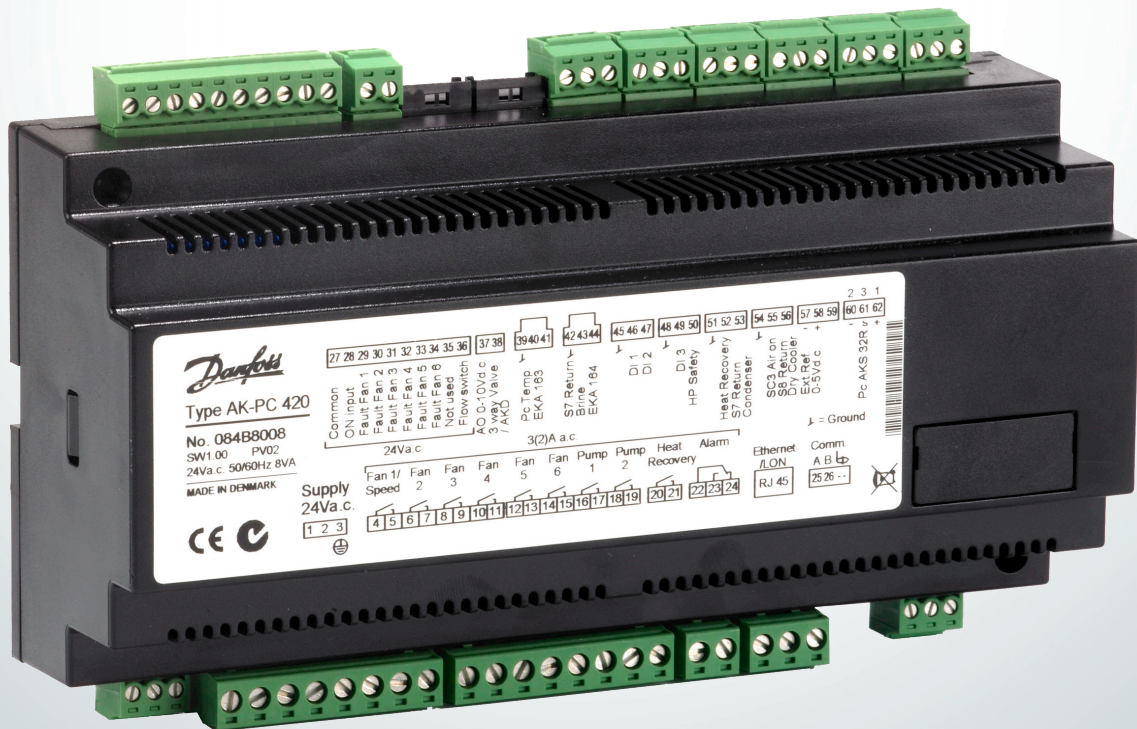

Introduction

Application

The controller is used for capacity regulation of a dry cooler including fans, three-way valve and pumps.

Advantages

- Complete dry cooler control
- Several combination options for sensor selection
- Heat recovery acc. to external voltage signal.

Regulation

Capacity regulation can include fans combined with a three-way valve or just fans. The following sensor signals can be used in regulation:

- Condensing pressure Pc
- Brine temperature S7, located immediately after the three-way valve outlet
- Brine temperature S8, located by the outlet from the dry cooler
- Outdoor temperature sensor Sc3, located by the air inlet to the dry cooler.

- Either S7, Pc or S8 can be used as a regulation sensor.

Functions

- Three-way valve control
- Speed regulation or step-by-step coupling of up to six fans
- Safety monitoring of fans
- Overriding of reference acc. to external voltage signal or outdoor temperature
- Separate reference for heat recovery
- Control and monitoring of twin pumps
- Monitoring of flow switch
- Contact inputs to alarms
- External start/stop of regulation
- Data communication via extra module

Operation

All operation takes place either via data communication or via connection of a display type EKA 164.

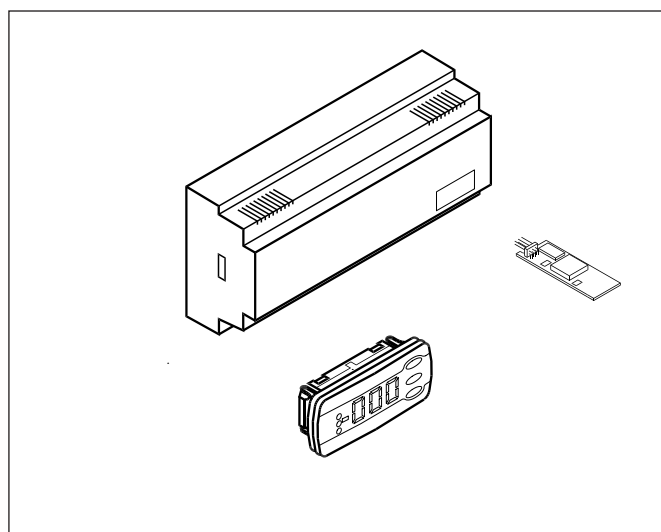
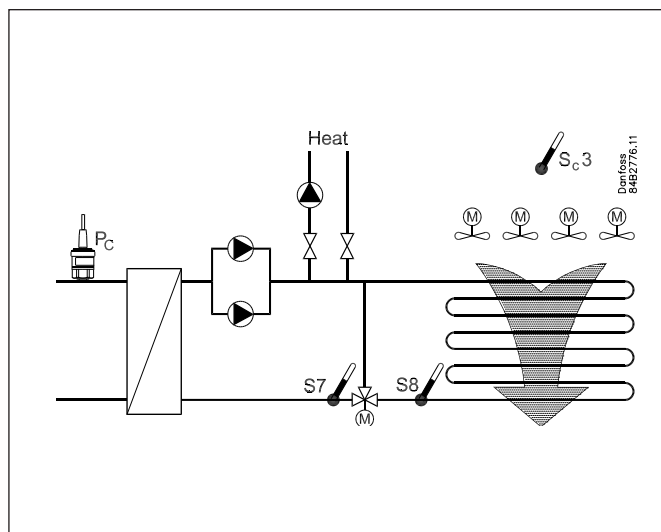

Contents

Introduction	2
Function	3
Survey of functions	8
Operation	13
Menu survey	14
Connections	16
Data	17
Ordering	17
Montage	17
Appendix - Reference and regulation	18

Function

Application

Regulation sensor and system type are selected via one single setting. The setting will define both the regulation sensor, if a three-way valve is being used, and how the fans are to be controlled. The fans are controlled either in steps or together with a speed control. If steps are used, up to six fans can be controlled.

Regulation (o61)	Regulation sensor	Optional sensor	3-way valve	Fan control
1	S7	S8 (P + PI)	x	Step
2	S7	S8 (P + PI)	x	Speed
3	Pc	S7 / S7+S8 (PI)	x	Step
4	Pc	S7 / S7+S8 (PI)	x	Speed
5	S8			Step
6	S8			Speed

Application 1-4

The capacity here is controlled via the fans combined with a three-way valve.

Applications 1 and 2 use brine return temperature S7 at the three-way valve outlet as regulation sensor and the fan capacity is controlled either in steps or via speed control.

The S8 sensor, which is fitted to the dry cooler's outlet should be used in the control if there is a large distance between the dry cooler and the three-way valve. Use of the S8 sensor will provide more robust regulation, which takes long pipe lengths into account. The S8 sensor must be fitted close to the dry cooler's outlet.

Applications 3 and 4 use brine condensation pressure Pc as regulation sensor and the fan capacity is controlled either in steps or via speed control.

For PI control the use of the S7 and S8 sensors is optional but they should be fitted if there is a large distance between the dry cooler and the three-way valve. Use of the sensors will provide more robust regulation, which takes long pipe lengths into account. The S8 sensor must be fitted close to the dry cooler's outlet.

For P control the S7 and S8 sensors are not used in the regulation, but they can be fitted to ensure that the emergency control functions in the even of the Pc signal failing.

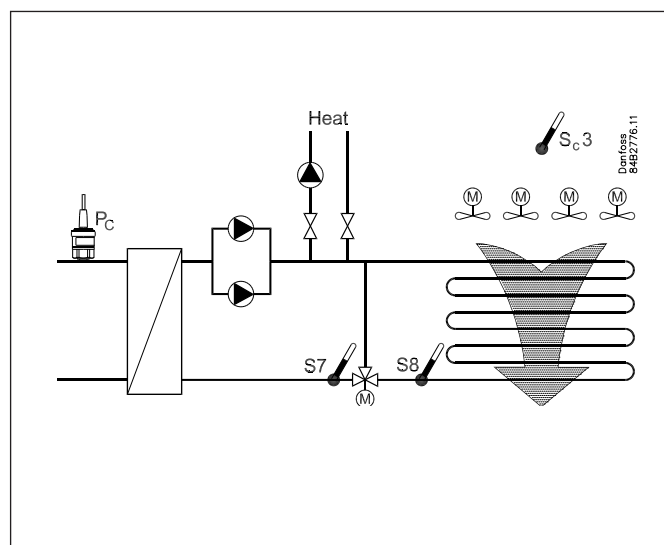

Applications 5-6

Here the capacity is controlled via step-by-step coupling or speed control on the basis of the dry cooler's discharge temperature S8. This application is used in particular when another controller takes care of the regulation of the three-way valve, e.g. to cool several parallel-coupled condensers.

NB.

The sensors Pc and S7 must not be located in positions other than those specified, as they are used for emergency regulation if the primary regulation sensor develops a fault.

The S8 sensor can be located in a different position than the one indicated if it is not used in the control.

If the S8 sensor is required in the control, the setting "o96, S8 optional" must be selected as ON.

If the S8 sensor is not used in the regulation, it can be located anywhere.

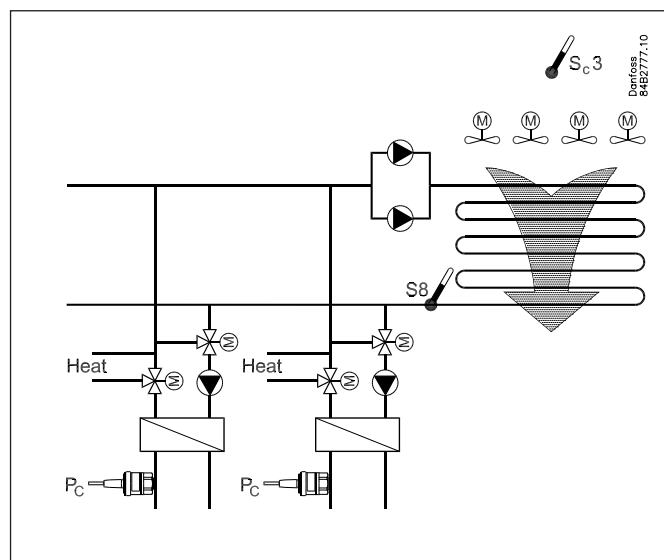

Capacity regulation

Three-way valve + step-by-step coupling of fans (applications 1 and 3)
Capacity regulation takes place via a P or PI regulation, which controls the three-way valve and subsequent step-by-step coupling of the fans.

First of all regulation takes place on the three-way valve via the analogue output. The output can be set at 0-10V or 10-0V, depending on which valve function is desired. Only when the three-way valve is fully open do the fans start up.

The capacity of the three-way valve is 50% of the total capacity. The P/PI controller has separate regulation settings (proportional band and integration time) for the three-way valve and the fans respectively.

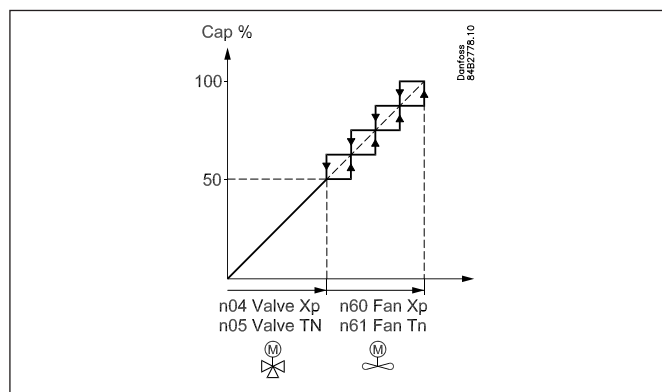

Capacity overlap – start of fans

As mentioned above, the three-way valve comprises a fixed 50% of the total capacity. In some systems it may be necessary to start the fans slightly before (or slightly after) the three-way valve has been fully opened. An overlap is created here between the three-way valve and the start of the fans. This is done by changing the setting “FanCap OFF%” from 50% to, for example, 40% (the setting defines the capacity at which the last fan stops). In this case the fans are started before the three-way valve is fully open.

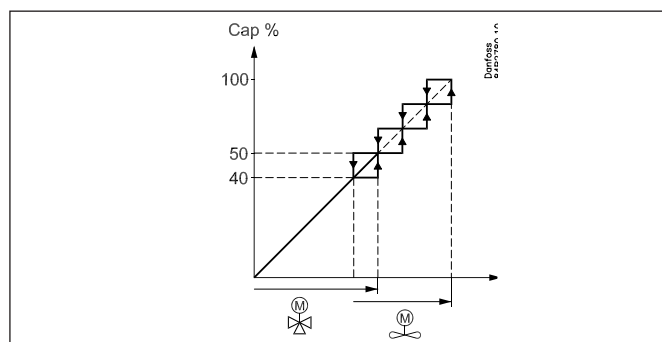

Three-way valve + speed control of fans (applications 2 and 4)

Capacity regulation takes place via a P or PI regulator, which controls the three-way valve and subsequent speed control of the fans. Here the analogue output signal is divided between the three-way valve and the frequency converter (50% of the analogue output signal is always used for the three-way valve), i.e. if the analogue output signal is set at 0-10V, 0-5 V is used for the three-way valve.

The frequency converter/fans are controlled via the relay output for fan 1 on the basis of the setting “FanCapOFF%”.

In the event of falling capacity, the relay output for fan 1 will be disabled when the actual capacity has fallen to “FanCap OFF%”. To achieve hysteresis when starting/stopping the frequency converter, the relay output for fan 1 will, when capacity is increasing, be enabled when the desired capacity is “FanCap OFF%” + “10% fan capacity”.

If “FanCapOFF%” is set at above or below 50%, the frequency converter can be started after or before the three-way valve is fully opened.

The P/PI controller has separate regulation settings (proportional band and integration time) for the three-way valve and the fans respectively.

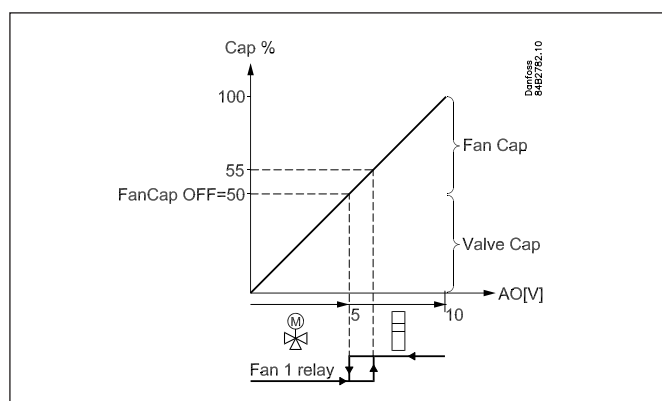

Fan control only (applications 5 and 6)

Capacity regulation takes place via a P or PI regulator, which controls the fans either with step-by-step coupling or speed control. The analogue output and a frequency converter are used for speed control. The relay output for fan 1 is used to start/stop the frequency converter.

In the event of falling capacity, the relay output for fan 1 will be disabled when the actual capacity has fallen to “FanCap OFF%”. To achieve hysteresis when starting/stopping the frequency converter, the relay will become enabled when the desired capacity is the fan capacity above “FanCap OFF%” (The 10% fan capacity will correspond to hysteresis of 1 V in the analogue output signal, when the signal is 0-10 V.)

The P/PI controller only uses regulation settings (proportional band and integration time) for the fans.

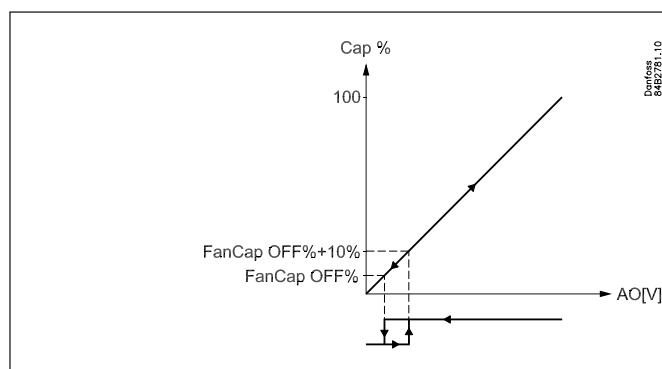

Linear/non-linear capacity curve for fans

The first fan step provides relatively more capacity than the subsequent capacity steps. The increase in capacity that an extra step/speed will generate falls gradually, as more and more steps are connected/the speed is increased.

The fan regulation therefore has a crooked capacity curve, which provides optimal reinforcement at both high and low capacities. However, for some systems a straight curve is required for capacity regulation, e.g. if the analogue signal is used for more than controlling fans. In this instance the capacity curve can be set at linear. (The capacity curve for the three-way valve will always be straight.)

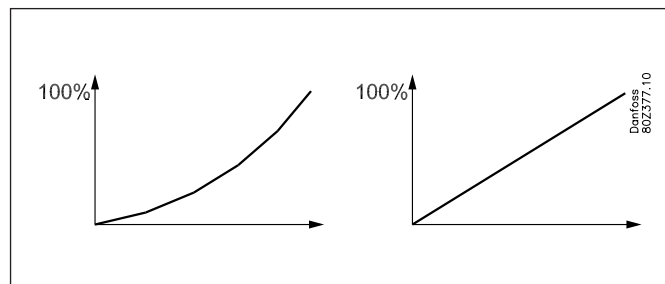

Step-by-step coupling of fans

The fans can either be connected in the sequence defined for them (sequentially) or they can be connected in rotation (sequentially with alternating start).

In sequential operation all fans are enabled at least once every 24 hours, so no fan rusts up due to being inactive for a longer period of time.

In rotation the various fans take turns in being first.

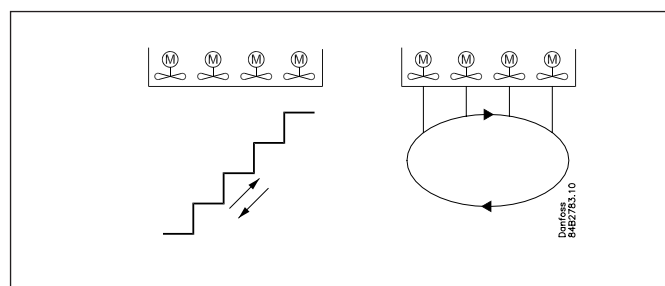

Monitoring fans

The controller must receive a signal of the status of each defined condenser step's safety circuit. The signal is taken directly from the safety circuit and connected to a "DI" input.

If the safety circuit is broken, the controller will lose the signal and emit an alarm.

The associated relay output will not be disconnected. The reason is that fans are often connected in pairs, but with one single safety circuit. If there is a fault in one fan, the other will continue to operate.

If no monitoring is desired, the input must be permanently wired at 24 V.

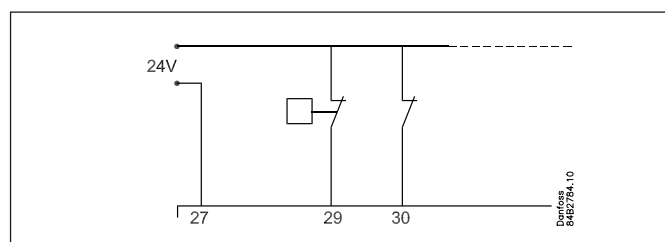

Reference

Regulation reference

The regulation reference can be defined in one of the following two ways:

- Fixed setting

The set point for the regulation sensor is set in °C.

If displacement is required, the reference can be displaced with a 0-10 V signal. During setup you define how great the displacement is to be at the signal's max. and min. value.

- Floating reference according to outdoor temperature

This function allows the reference to vary according to the outdoor temperature within a defined range.

The outdoor temperature is measured with the Sc3 sensor, and the reference will always fall within a fixed value (min. tm) above the measured outdoor temperature.

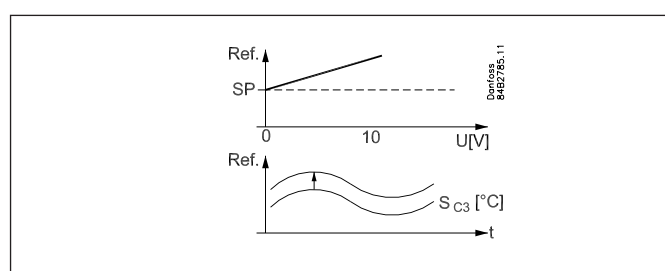

Heat recovery

When heat recovery is enabled via the digital input, the reference will switch to another set point "Heat SP", although this too can be overridden via the external 0-10 V signal. At the same time the relay for heat recovery is enabled, which then transmits a signal to either a pump or a valve. The reference's max. value (r30) is overridden from the set value to 99.9° C.

If heat recovery is in progress and the temperature by the regulation sensor is lower than the reference's set minimum value, the following happens (see also the following section on limiting the reference):

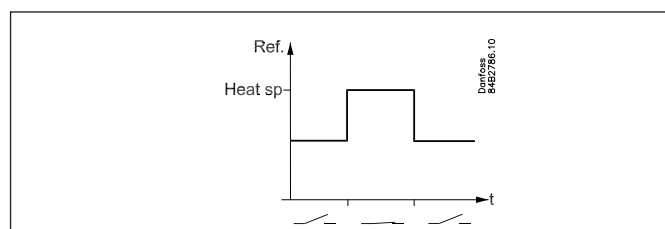

The heat recovery relay is disconnected and can only be re-enabled once the temperature by the regulation sensor has reached 2 K above the reference's minimum setting.

Ramp function

To avoid overshoot and undershoot of the reference, a ramp function has been included to guarantee that the reference cannot change more quickly than the preset ramp in Kelvin/minute.

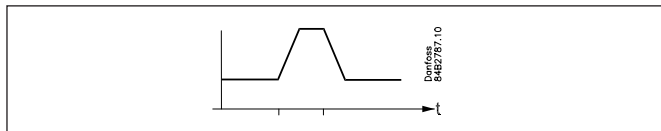

Limitation of reference

To protect against regulation reference that is too high or too low, a limit must be set for the reference. The limit is valid under normal regulation, but is increased during heat recovery to 99.9° C.

The upper limit is always an absolute value. The lower limit can either be an absolute value or it can vary in accordance with the outside temperature Sc_3 whereby the limit has a fixed value ("r56, Min tm") above the outside temperature. This means that a reference below the minimum value, making all fans run continuously, can be avoided.

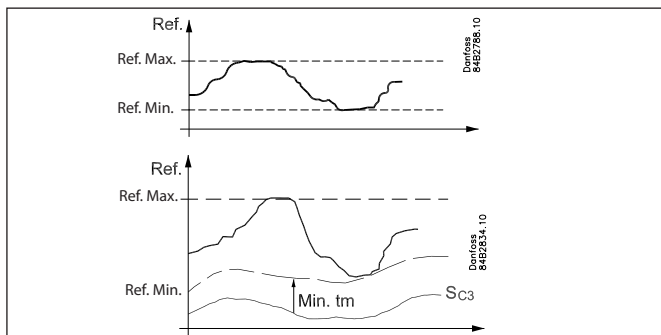

P or PI regulation with floating or fixed reference

See appendix.

Safety functions

Monitoring of condensation pressure

The controller has a safety function that provides protection against the condensation pressure being too high.

The function can be enabled in two ways.

- Digital input - HP safety

When the digital input is connected, full capacity is cut in to both fans and three-way valve. An alarm is emitted at the same time.

The capacity remains cut in until the digital input is interrupted, at which point the alarm is also cancelled. The digital input can possibly be connected to an external safety pressure control.

- Measuring the Pc/S7 temperature

This function always uses condensation pressure Pc if the pressure signal is connected. If Pc is not fitted, brine return temperature S7 is used instead.

The function cuts in all condenser steps and emits an alarm if the measured temperature is higher than 3 K below the set limit "S7/Pc max".

Normal capacity regulation is restored when the temperature (pressure) has once more fallen to 3 K below the limit, and a delay time of 60 seconds has passed.

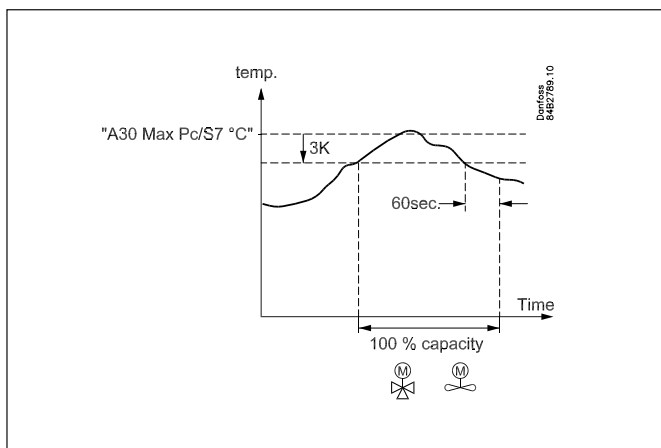

Pump control

The controller can control and monitor one or two pumps that circulates the brine.

If two pumps are used and operating time equalisation is selected, the controller can also execute a switch between the two pumps if operating alarms occur.

Pump selection is performed using the following settings:

- 0: Both pumps are stopped
- 1: Pump 1 is started
- 2: Pump 2 is started
- 3: Both pumps are started
- 4: Automatic switch between the pumps is permitted. Start before stop
- 5: Automatic switch between the pumps is permitted. Stop before start

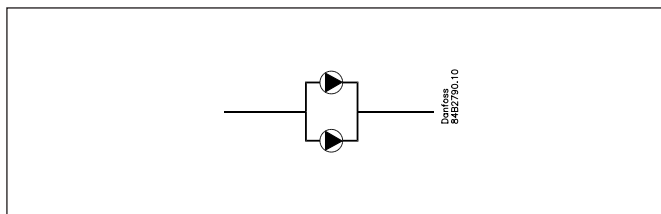

Automatic switch between the pumps. Start before stop

(only for setting = 4)

This setting allows a rotation between the two pumps, enabling a kind of operating time equalisation. The period time between the pump switches can be set as "p37 PumpCycle".

When switching, the pump will be kept running for the time "p36 PumpDel" until it stops.

Automatic switch between the pumps. Stop before start

(only for setting = 5)

This setting allows a rotation between the two pumps, enabling a kind of operating time equalisation. The period time between the pump switches can be set as "p37 PumpCycle".

When switching, the pumps will be stopped in the time "p36 PumpDel".

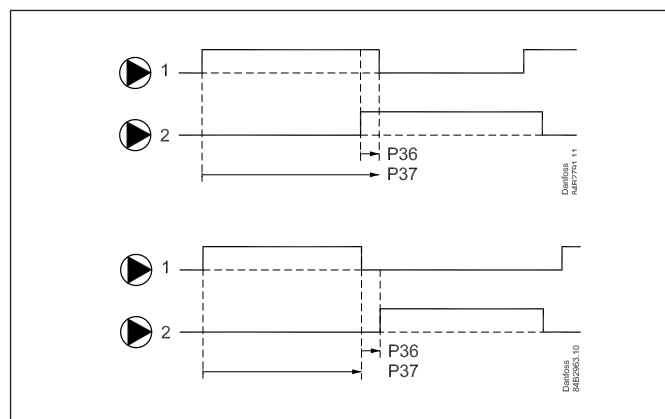

Monitoring pumps

The controller monitors the pumps' operation via the safety input "Flowswitch". The signal may, for example, originate from a pressure difference pressure switch or a flow switch.

Also set a delay time to define how the alarm is to be activated.

The delay time is the time from when the input loses the signal until the controller emits an alarm and executes a pump switch if necessary.

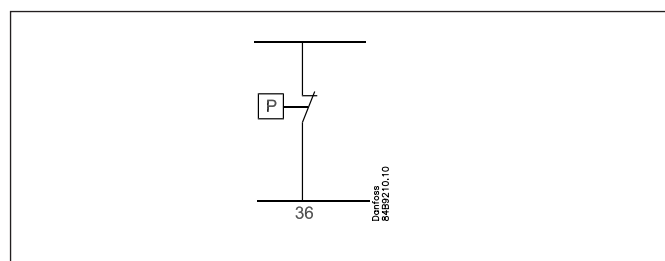

Special information about operating time equalisation

If the pumps are operating with operating time equalisation, the controller can perform a switching of the pumps in the event of a lack of flow (however, the pump switch will only be performed when the delay time on the alarm has expired).

Depending on whether the pump switch rectifies the alarm situation or not, the following happens:

1) The pump switch rectifies the alarm situation

If the pump switch rectifies the alarm situation, the non-faulty pump, which is now in operation, will run until the normal cycle time has expired. It then switches back to the "faulty pump", as it is assumed that this has been repaired. At the same time the alarm situation is reset (the alarm is acknowledged).

If the "faulty pump" has not been repaired, another alarm will be triggered and cause one more switch to the non-faulty pump. This is repeated until the situation has been rectified.

2) The pump switch does not rectify the alarm situation

If, however, the alarm is still active after the pump switch, the controller will also emit an alarm for the other pump. At the same time both pump outputs are enabled in an attempt to create sufficient flow for the alarm situation to be rectified. The controller will then have both pump outputs enabled until the normal cycle time has expired. A normal pump switch is then conducted and the active alarms are reset.

Separate alarm priorities can be set for the failure of one pump and the failure of both pumps. See section entitled "Alarms and messages".

Survey of functions

Function	Parameter	Parameter by operation via data communication
Normal display		
If the two displays are mounted: The regulation temperature is displayed on EKA 164 (the one with buttons) (Pc or S7 or S8) Pc will be shown on EKA 163. Both readouts will be in temperature		S7 °C Pc °C S8 °C
Reference		Condenser control
Unit Here you can select whether the display is to indicate temperatures in °C or °F 0: Will give °C / bar 1: Will give °F / psig	r05	Unit (In AKM only °C is used, whatever the setting)
Start/stop of refrigeration Start/stop of refrigeration may also be performed with an external contact function connected to the input named "ON input". (The input must be wired).	r12	Main Switch
Set point When "r33 ctrl.mode" is set at 1 or 3, it is regulated according to the set value + a possible displacement from a 0-10 V signal. See also page 18.	r28	Set Point °C
Reference variation. See also page 18. Regulation with setting 1 (or 2 if the reference is to vary with the outdoor temperature) will give the best regulation if the system is in balance. But if a lot of fans are connected, it may be necessary to select setting 3 instead (or 4, if there is regulation with the outdoor temperature). (Settings 3 and 4 will generally be preferable if a offset can be accepted between the reference and the actual regulation temperature) 1: No change of the reference. Regulation based on set setpoint + displacement with a 0-10 V signal. If there is a heat recovery signal, the reference will switch to the preset set point in "r64". 2: Outdoor temperature forms part of the reference. The outdoor temperature is measured with Sc3 sensor and the reference will always have a fixed value "r56 Min tm K" over the measured outdoor temperature. If there is a heat recovery signal, the reference will switch to the preset set point in "r64". Setting 1 and 2 operate with a PI regulation, but if the system is unstable and the PI regulation not satisfactory the I element may be left out, so that the controller will be with P regulation only. 3: As 1, but with P regulation (xp-band) 4: As 2, but with P regulation (xp-band) 5: As for 1, but with a minimum reference limit in accordance with outdoor temperature Sc3 6: As for 3, but with a minimum reference limit in accordance with outdoor temperature Sc3	r33	Ctrl. mode
Reference The regulation reference is shown here.	r29	Ref. °C
Set point limitation With these settings the setpoint can only be set between the two values. (This also applies to regulations where the Xp band lies above the reference).		
Max. permissible setpoint value. (Is set as an absolute value)	r30	RefMax °C
Min. permissible setpoint value. (Is set as an absolute value when "r33" = 1-4)	r31	RefMin °C
Correction of pressure measurement Pc An offset adjustment of the registered pressure can be made.	r32	AdjustPc
Dimensioning temperature Min tm The mean temperature difference across the condenser at low capacity (tm difference at max. load). This is the temperature difference between the air and condensing temperature. When "r33 Ctrl. Mode" is set at 2 or 4, regulation takes place according to a reference that is "Min tm" over the measured outdoor temperature.	r56	Min tm K
Reading of regulation temperature This is where you can see the actual temperature being measured by the sensor chosen for capacity regulation. The value is displayed in °C.	r58	Ctrl temp
Set point value for heat recovery When a heat recovery signal is received, regulation takes place according to the value set here + any displacement via 0-10 V signal.	r64	Heat SP°C
Average value for reference changes A switch in the reference will be ramped up or down over this period of time. Set in Kelvin/minute.	r65	RefRamp

Reference displacement at max. signal (Ext. ref.) Here the value is set by which the reference is to be displaced when the input signal Ext. ref. is max. (10 V).	r68	ExtRefMax
Reference displacement at min. signal (Ext. ref.) Here the value is set by which the reference is to be displaced when the input signal Ext. ref. is min. (0 V).	r69	ExtRefMin
Correction of signal from S7 Compensation possibility due to long sensor cable	r72	Adjust S7
Correction of signal from S8 Compensation possibility due to long sensor cable	r73	Adjust S8
Condenser capacity		
Definition of condenser and number of fans (may only be set if step-by-step coupling is being run, i.e. "o61 Applic mode" is set at 1, 3 or 5). Here you set how many fan steps are to be used for regulation (to max. 6). 1-6: All fans are connected with relays. Relay 1 is assigned fan 1, the next one number 2, etc. 7-10: Not used 11-16: Total number of fan relays (as 1-6), but here the starting sequence is altered after each time all fans have been stopped. NB The controller must receive a signal of the status of each condenser step's safety circuit. The signal must be connected to the associated DI input.	c29	Fan mode
Definition of output voltage to valve/speed control Output signal is 0-10 V or 10-0 V. The signal can be either linear or un-linear, so that it can be adapted to the desired characteristics. 1: 0-10 V, linear 2: 10-0 V linear (not at shunt and fan speed) 3: 0-10 V, unlinear 4: 10-0 V unlinear (not at shunt and fan speed)	c34	AO type
	-	--- Cond Cap % Read cut-in condenser capacity
Regulation parameters		
Proportional band xp for valve regulation (P = 100/Xp) If the Xp value is increased, the regulation becomes steadier	n04	Valve Xp K
I: Integration time Tn for valve regulation If the Tn value is increased, the regulation becomes steadier	n05	Valve Tn s
Manual control of condenser capacity This sets the capacity that is to be cut in when switching to manual control.	n52	ConManCap%
Manual control Manual control of the condenser capacity is enabled here. When set to ON, the capacity that is specified in "n52" is cut in. The setting will fall back to "Off" if the Main switch is set to Off or if there is a power outage.	n53	ConManCap
P: Proportional band xp for fan regulation (P = 100/Xp) If the Xp value is increased, the regulation becomes steadier	n60	Fan XP K
I: Integration time Tn for fan regulation If the Tn value is increased, the regulation becomes steadier	n61	Fan Tn s
Capacity overlap between valve and fans In valve regulation the first 50% of the capacity is controlled by the valve. When the valve is fully open continues with fan cut-in. The fans then take over. If the fans are to start before the three-way valve is fully open, a value must be set that is lower than 50%. If the fans are only to start after the three-way valve is fully open, a value must be set that is higher than 50%.	n62	FanCap OFF %
Alarm		
Alarm settings		
The controller can give alarm in different situations. When there is an alarm the light-emitting diodes (LED) will flash on the display and the alarm relay will cut in.		
Pc max. (Alarm and safety function, see also page 18.) Here you set when the alarm at too high condensing pressure is to enter into effect. The value is set as an absolute value.	A30	Max. Pc. / S7
Alarm delay DI1 (an interrupted input will give alarm). The time delay is set in minutes. At min. setting the alarm is cancelled.	A27	DI1AlrmDelay

Alarm delay DI2 (an interrupted input will give alarm). The time delay is set in minutes. At min. setting the alarm is cancelled.	A28	DI2AlrmDelay
Alarm delay DI3 (an interrupted input will give alarm). The time delay is set in minutes. At min. setting the alarm is cancelled.	A29	DI3AlrmDelay
Pump alarm delay The time delay is set in seconds. At min. setting the alarm is cancelled.	A63	Pump Al. Del
Give the top button a brief push to zeroset the alarm and to have the message shown on the display.		Reset alarm The function zerosets all alarms when set in pos. ON.
		With data communication the importance of the individual alarms can be defined. Setting is carried out in the " Alarm destinations " menu.
Miscellaneous		Miscellaneous
Choice of application The regulator can be configured in various ways. The application that is required out of the six applications available is set here. 1: S7 + 3-way valve + Step of fans 2: S7 + 3-way valve + VSD (speed) of fans 3: Pc + 3-way valve + Step of fans 4: Pc + 3-way valve + VSD (speed) of fans 5: S8 + Step of fans 6: S8 + VSD (speed) of fans	o61	Applc.Mode
Sensor type (Sc3, S7 and S8) Normally a Pt1000 sensor with great signal accuracy is used for temperature measurement. But a PTC sensor may also be used (r25 = 1000) in special situations. 0 =Pt1000 1 =PTC1000	o06	Sensor type
Pressure transmitter's working range Depending on the pressure, a pressure transmitter with a given working range is used. This working range must be set in the controller (e.g.: -1 to 34 bar The values must be set in bar if display in °C has been selected. And in psig, if °F has been selected.		If the values are to be set from the AKM programme, they must be set in bar.
Pc-Min. value	o47	PcMinTrsPres
Pc-Max. value	o48	PcMaxTrsPres
Use of DI4 input The digital input can be connected to a contact function, and the contact can now be used for one of the following functions: Setting / function: 0 : DI input not used 1 : Safety signal from high-pressure pressure control. If the signal is cut off, all capacity is cut in. There is no time delay.	o22	DI4 control
Operating hours The operating hours for the pump relays can be read and set in the following menus. The read value is multiplied by 1000 to obtain the number of hours (fx. shows 2.1 for 2100 hours). On reaching 99.9 hours the counter stops and must now be reset to, say, 0. There will be no alarm or error message for counter overflow.		(In the AKM display the hour number has not been multiplied)
Value for relay number 7 (pump 1)	o52	DO7 run hour
Value for relay number 8 (pump 2)	o53	DO8 run hour
Refrigerant setting (only if a Pc pressure transmitter is fitted) Before refrigeration is started, the refrigeration must be defined. You may choose between the following refrigerants: 1=R12. 2=R22. 3=R134a. 4=R502. 5=R717. 6=R13. 7=R13b1. 8=R23. 9=R500. 10=R503. 11=R114. 12=R142b. 13=User defined. 14=R32. 15=R227. 16=R401A. 17=R507. 18=R402A. 19=R404A. 20=R407C. 21=R407A. 22=R407B. 23=R410A. 24=R170. 25=R290. 26=R600. 27=R600a. 28=R744. 29=R1270. 30=R417A. 31=R422A. 32=R413A. 33=R422D. 34=R427A. 35=R438A. Warning: Wrong selection of refrigerant may cause damage to the compressor. Other refrigerants: Select setting 13 here, and subsequently three factors have to be set – fac1, fac2 and fac3 – via AKM.	o30	Refrigerant

Manuel operation (only via display and only when regulation has stopped (r12=off)) From this menu the relays can be cut in and out manually. 0 gives no override, but a number between 1 and 10 will cut in a belonging relay. 1 will cut in relay number 1, 2 relay 2, etc. 11-18 will produce voltage on the analog output. Setting 11 will give a voltage of 1.25 V, setting 12 will give 2.5 V, etc.	o18	---
Frequency Set the net frequency.	o12	50 / 60 Hz (50=0, 60=1)
Use of S8 sensor If application (o61) is selected to 1, 2, 3 or 4, the S8 sensor can be used for regulation or for monitoring. The S8 sensor, which has to be located near by the outlet of the dry cooler, should be used in the regulation if the distance between the dry cooler and the 3-way-valve is long. If the S8 sensor is want to be used in the regulation set o96 to ON. Is the S8 sensor not used in the regulation it can be located optional for monitoring purpose (o96 has to be set to OFF).	o96	S8 optional
Address If the controller is built into a network with data communication, it must have an address, and the master gateway of the data communication must then know this address. These settings can only be made when a data communication module has been mounted in the controller and the installation of the data communication cable has been completed. This installation is mentioned in a separate document "RC8AC".		Following installation of a data communication module, the controller can be operated on a par with the other controllers in ADAP-KOOL® refrigeration controls.
The address is set between 1 and 240 (gateway determined)	o03	
The address is sent to the gateway when the menu is set in pos. ON	o04	
Access code If the settings in the controller are to be protected by a numerical code, you can set a numerical value between 0 and 100. If not, you can cancel the function with setting OFF.	o05	
Status on relay outputs		
Status on relay 1 (fan 1 or start/stop of speed control)	p25	Fan 1 status
Status on relay 2 (fan 2)	p26	Fan 2 status
Status on relay 3 (fan 3)	p27	Fan 3 status
Status on relay 4 (fan 4)	p28	Fan 4 status
Status on relay 5 (fan 5)	p29	Fan 5 status
Status on relay 6 (fan 6)	p30	Fan 6 status
Status on relay 7 (pump 1)	p31	Pump 1
Status on relay 8 (pump 2)	p32	Pump 2
Status on relay 9 (Heat recovery)	p33	Heat recovery
Status on relay 10 (alarm)	p34	Alarm
Pump control Here you define how the pumps are to be controlled: 0: Both pumps are stopped 1: Only pump 1 is started 2: Only pump 2 is started 3: Both pump 1 and pump 2 are started 4: Automatic switch between pumps 1 and 2. Start before stop 5: Automatic switch between pumps 1 and 2. Stop before start	p35	Pump ctrl.
Pump-stop delay During pump switching both pumps can run for a short overlap. Here you set how many seconds.	p36	Pump del.
Run period in cyclic operation This is where you set the number of hours the pump will run. You then switch over to the other pump. Repeat this.	p37	Pump cycle
Status on DI 1	u10	DI 1 Status
Status on DI 2	u37	DI 2 Status
Reading temperature at Sc3 sensor	u44	Sc3 Status
Status on DI 3	u87	DI 3 Status
Status on DI 4	u88	HP safety
Status on DI 5	u89	Heat recov.
Reading temperature at S8 sensor	u93	S8 temp
Status on Flow switch input	u94	Flow switch
Read off the actual reference displacement received in the analogue input Ext. Ref.	u96	Ext. Ref°C
Read off the value on the analogue output to the valve/frequency converter.	u97	AO Volt
Reading temperature at S7 sensor	u98	S7 temp

Operating status	
The controller goes through some regulating situations where it is just waiting for the next point of the regulation. To make these "why is nothing happening" situations visible, you can see an operating status on the display. Push briefly (1s) the upper button. If there is a status code, it will be shown on the display. The individual status codes have the following meanings	Ctrl state (0 = regulation)
S10: Regulation stopped with the internal and external start/stop	10
S25: Manual regulation of outputs	25
Alarm messages	Alarms "Destinations"
A11: No refrigerant has been selected (cf. o30)	A11 No RFG Sel
A17: High Pc	A17 Hi Pc alarm
A28, A29, A30: External alarm. Interrupted signal on input "DI1" /2/3	A28 A30 DI_ Alarm
A34, A35, A36, A37, A46, A47: Fan alarm. Fan 1, 2, 3, 4, 5, 6	A34 A37, A46, A47 Fan_fault
A45: Regulation stopped with setting or with external switch	A45 Stand by
A77: Interrupted signal on input "Flow switch" while pump 1 was operating	A77 Pump 1 fault
A78: Interrupted signal on input "Flow switch" while pump 2 was operating	A78 Pump 2 fault
A79: Interrupted signal on input "Flow switch" while pump 1 and 2 were operating	A79 PMP1&2 fault
E1: Error in the controller	E1 Ctrl. fault
E2: Control signal outside the range (short-circuited/interrupted)	E2 Out of range

Safety functions

Criterion	Reference / control sensor	Capacity
Pc or S7 > Pc/S7 max (A30) - 3	No change	100% capacity until the signal has fallen below the limit for 60 seconds.
Pc signal failure	S7 is used instead and the reference is lowered 5 K.	Normal regulation
S7 signal failure	Pc is used instead and the reference is raised 5 K.	Normal regulation
Pc and S7 signal failure	No change	100% capacity
Sc3 signal failure	The floating reference is removed, and regulation takes place according to the set value for the reference – "r29".	Normal regulation
S8 signal failure	No change	When using app. 1-4, regulation continues without S8 sensor. When using app. 5-6, 100% capacity is cut in.

Operation

Data communication

If the controller is extended with data communication, the operation can be performed from a system unit. The parameter names for the functions can be viewed in the right-hand column on pages 8–12.

The importance of the alarms that are sent can be defined with the setting: 1 (High), 2 (Medium), 3 (Low) or 0 (No alarm).

Operation via external display

The values will be shown with three digits, and with a setting you can determine whether the pressures are to be shown in °C or in °F (bar/psig).

There are two options for the display.

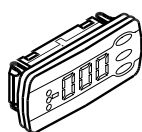

EKA 164

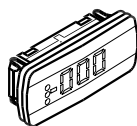

EKA 163

EKA 164

To operate the controller and view the regulation temperature. If the lowermost key is pressed, the temperature from one of the other sensors will be shown briefly in the display.

Regulation	Normal display	Alternative view
	Regulation sensor	(lowermost key)
1 and 2	S7	Pc
3 and 4	Pc	S7
5 and 6	S8	S7

EKA 163

If the alternative temperature is to be shown constantly, a display without operating keys can be connected.

The buttons on the display

When you want to change a setting, the upper and the lower buttons will give you a higher or lower value depending on the button you are pushing. But before you change the value, you must have access to the menu. You obtain this by pushing the upper button for a couple of seconds - you will then enter the column with parameter codes. Find the parameter code you want to change and push the middle button. When you have changed the value, save the new value by once more pushing the middle button.

Or short:

1. Push the upper button (long push) until a parameter is shown
2. Push one of the buttons and find the parameter you want to change
3. Push the middle button until the setting value is shown
4. Push one of the buttons and select the new value
5. Push the middle button again to conclude the setting

(A brief pushing will show the active alarm codes. See page 15.)

Menu survey

Configuration parameters can only be set when the regulation is stopped, r12=0.

SW: 1.2x

Function	Parameter	Min.	Max.	Fac. sett.
Normal display				
A display of the regulated temperature can be seen in EKA 164. (display with buttons)	-		°C	
Shows Pc in EKA 163	-		°C	
Reference				
Select unit (0=bar and °C, 1=Psig and °F)	r05	0	1	0
Start/Stop of regulation	r12	OFF	ON	OFF
Set regulation setpoint	r28	-25°C	75°C	30°C
Shows the total reference	r29		°C	
Limitation: reference max. value	r30	-99.9°C	99.9°C	55.0°C
Limitation: reference min. value	r31	-99.9°C	99.9°C	-99.9°C
Correction of signal from Pc-sensor	r32	-50 K	50 K	0.0
Pc reference variation. 1 and 2 are PI-regulation 1: Fixed reference. "r28" is used 2: Variable reference. Outdoor temperature (Sc3) included in the reference 3: As 1, but with P-regulation (Xp-band) 4: As 2, but with P-regulation (Xp-band) 5: As 1, but with min.-reference acc. to outdoor temperature 6: As 3, but with min.-reference acc. to outdoor temperature	r33	1	6	1
The mean temperature difference across the condenser at the lowest relevant capacity (min tm K)	r56	3.0	50.0	8.0
This is where you can see the actual temperature that is part of the regulation.	r58		°C	
Set point settings for heat recovery	r64	-25°C	75°C	35°C
Average period for reference changes.	r65	0.1 K/min.	50 K/min.	10 K/min.
Displacement of reference at external signal = 10 V	r68	-50 K	50 K	0.0
Displacement of reference at external signal = 0 V	r69	-50 K	50 K	0.0
Correction of signal from S7-sensor	r72	-50 K	50 K	0.0
Correction of signal from S8-sensor	r73	-50 K	50 K	0.0
Capacity				
Definition of fan relay 1-6: Total number of fan relays in sequential operation. 7-10: Not used 11-16: Total number of fan relays in cyclic operation.	c29	0/OFF	16	0
Definition of the analogue output voltage 0-10 V 1: 0-10 V, linear 2: 10-0 V, linear 3: 0-10 V, unlinear 4: 10-0 V, unlinear	c34	1	4	1
Proportional band Xp for (P= 100/Xp) valve regulation	n04	0.2 K	40.0 K	10.0 K
I: Integration time Tn for valve regulation	n05	30 s	600 s	120
Cutin condenser capacity with manual control. See also "n53"	n52	0 %	100 %	0

Manual control of condenser capacity (when ON, the value in "n52" will be used)	n53	OFF	ON	OFF
Proportional band Xp for (P= 100/Xp) fan regulation	n60	0.2 K	40.0 K	20.0 K
I: Integration time Tn for fan regulation	n61	30 s	600 s	240
Definition of where the first fan is connected. Set as a % of the total refrigeration capacity. Ex. 50%, if a three-way valve is also used.	n62	0 %	70 %	50 %
Alarm				
Delay time for a DI1 alarm	A27	0 min. (-1=OFF)	999 min.	OFF
Delay time for a DI2 alarm	A28	0 min. (-1=OFF)	999 min.	OFF
Delay time for a DI3 alarm	A29	0 min. (-1=OFF)	999 min.	OFF
Upper alarm and safety limit for Pc	A30	-10 °C	200°C	60.0°C
Pump alarm delay	A63	1 s	600 s	15 s
Miscellaneous				
Controllers address	o03*	1	990	
On/off switch (service-pin message)	o04*	-	-	
Access code	o05	1 (0=OFF)	100	OFF
Used sensor type for Sc3, S7 and S8 0=Pt1000, 1=PTC1000	o06	0	1	0
Set supply voltage frequency	o12	50 Hz	60 H	0
Manual control of outputs: 0: No override 1-10: 1 will cut in relay 1, 2 relay 2, etc. 11-18: Gives voltage signal on the analog output. (11 gives 1.25 V, and so on in steps of 1.25 V	o18	0	18	0
Use of DI4-input 0=not used. 1=Safety signal from high pressure pressostat	o22	0	1	0
Setting of refrigerant 1=R12. 2=R22. 3=R134a. 4=R502. 5=R717. 6=R13. 7=R13b1. 8=R23. 9=R500. 10=R503. 11=R114. 12=R142b. 13=User defined. 14=R32. 15=R227. 16=R401A. 17=R507. 18=R402A. 19=R404A. 20=R407C. 21=R407A. 22=R407B. 23=R410A. 24=R170. 25=R290. 26=R600. 27=R600a. 28=R744. 29=R1270. 30=R417A. 31=R422A. 32=R413A. 33=R422D. 34=R427A. 35=R438A.	o30	0	35	0
Pc pressure transmitter's working range - min. value	o47	-1 bar	0 bar	-1.0
Pc pressure transmitter's working range - max. value	o48	1 bar	200 bar	34.0
Operating hours of relay 7 (value time 1000)	o52	0.0 h	99.9 h	0.0
Operating hours of relay 8 (value time 1000)	o53	0.0 h	99.9 h	0.0

To be continued

* this setting is only possible if data communication module is mounted in the controller

Selection of application Regulation sensor and output are: 1: S7 + 3-way valve + Step of fans 2: S7 + 3-way valve + VSD (speed) of fans 3: Pc + 3-way valve + Step of fans 4: Pc + 3-way valve + VSD (speed) of fans 5: S8 + Step of fans 6: S8 + VSD (speed) of fans	o61	1	6	1
Use of S8 On: for regulation Off: for monitoring	o96	Off/0	On/1	Off/0
Service etc.				
Status on relay 1 (fan 1)	p25			
Status on relay 2 (fan 2)	p26			
Status on relay 3 (fan 3)	p27			
Status on relay 4 (fan 4)	p28			
Status on relay 5 (fan 5)	p29			
Status on relay 6 (fan 6)	p30			
Status on relay 7 (pump 1)	p31			
Status on relay 8 (pump 2)	p32			
Status on relay 9 (heat recovery)	p33			
Status on relay 10 (alarm)	p34			
Pump control: 0: Both pumps stops 1: Pump 1 only 2: Pump 2 only 3: Both pump 1 and pump 2 4: 2 pumps + rotation. Start before stop 5: 2 pumps + rotation. Stop before start	p35	0	5	1
Pump setting. Operating time with two pumps when switching takes place.	p36	0 s	60 s	10 s
Pump setting. After the operating time you then switch over to the other pump.	p37	1 h	500 h	24 h
Status on DI1 input	u10			
Status on DI2 input	u37			
Read temperature at sensor "Sc3"	u44			°C
Status on DI3 input	u87			
Status on DI4 input	u88			
Status on DI5 input	u89			
Read temperature at sensor "S8"	u93			
Status on "Flow switch"-input	u94			
Read reference displacement from the external signal	u96			
Read the value of the analogue output in V	u97			
Read temperature at sensor "S7"	u98			

Factory settings are indicated for standard units (see code numbers, page 1). Other code numbers have customized settings.

The controller can give the following messages		
E1	Error message	Fault in controller
E2		Regulation is outside the range, or the control signal is defective
A11	Alarm message	Refrigerant not selected
A17		High Pc
A28		DI 1 alarm. Terminal 46 interrupted
A29		DI 2 alarm. Terminal 47 interrupted
A30		DI 3 alarm. Terminal 49 interrupted
A34		Fan 1 alarm. Terminal 29 is open
A35		Fan 2 alarm. Terminal 30 is open
A36		Fan 3 alarm. Terminal 31 is open
A37		Fan 4 alarm. Terminal 32 is open
A45		Regulation stopped
A46		Fan 5 alarm. Terminal 33 is open
A47		Fan 6 alarm. Terminal 34 is open
A77		Pump 1 alarm. Terminal 36 interrupted
A78		Pump 2 alarm. Terminal 36 interrupted
A79	Pump 1 and 2 alarm. Terminal 36 interrupted	
S10	Status message	Refrigeration stopped by the internal or external start/stop function
S25		Manual control of outputs
PS	Info	Access code is required before you have access to the settings

Messages can be brought up on the display by briefly pressing the uppermost key. If there is more than one alarm, they can be scrolled through

Factory setting

If you need to return to the factory-set values, it can be done in this way:

- Cut out the supply voltage to the controller
- Keep the upper and the lower button depressed at the same time as you reconnect the supply voltage

Connections

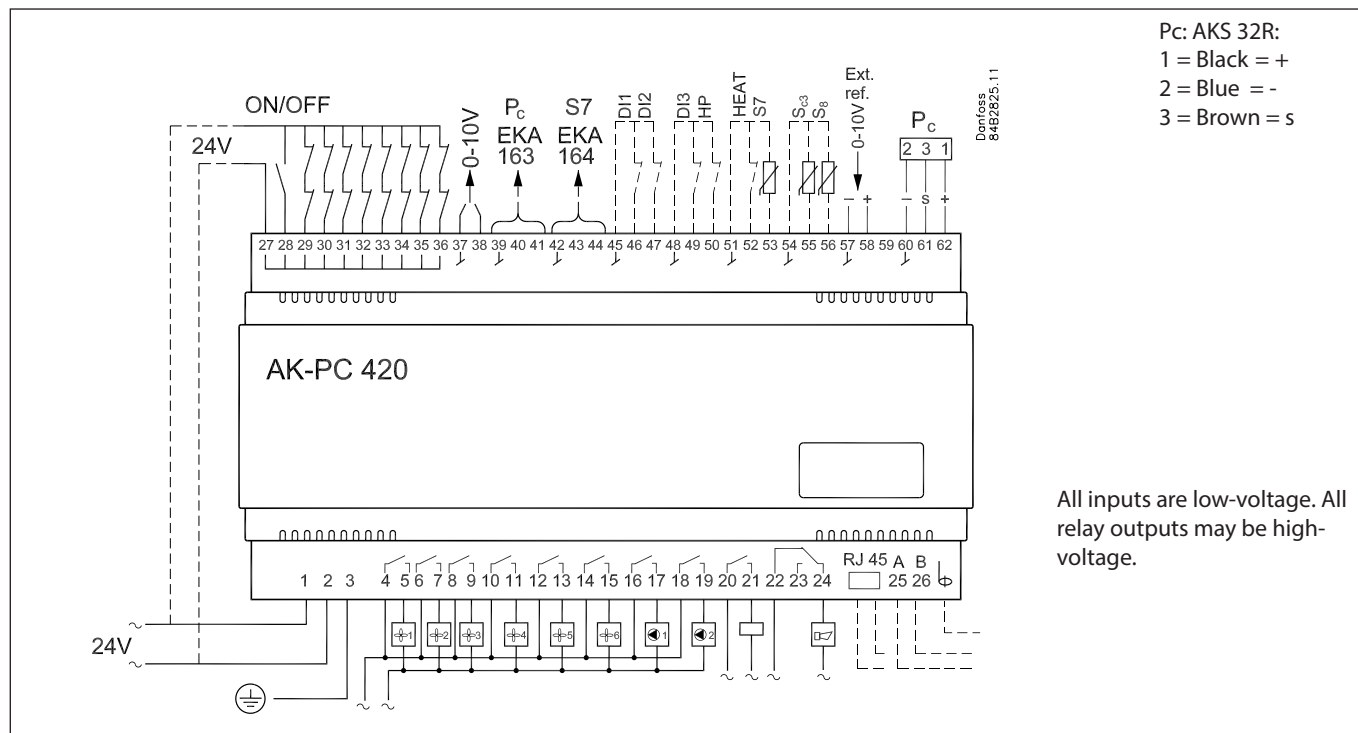

Terminals:

- 1-2 Supply voltage 24 V a.c.
 - 4- 15 Relay outputs for fan motors
 - 16-19 Relay output to pump 1 and pump 2
 - 20-21 Relay output to heat recovery
 - 22-24 Alarm relay
- There is connection between 22 and 24 in alarm situations and when the controller is dead

- 27-28 24 V signal to start / stop of regulation
- 27-29 24 V signal from the safety circuit fan 1
- 27-30 24 V signal from the safety circuit fan 2
- 27-31 24 V signal from the safety circuit fan 3
- 27-32 24 V signal from the safety circuit fan 4
- 27-33 24 V signal from the safety circuit fan 5
- 27-34 24 V signal from the safety circuit fan 6
- 27-35 (not used)
- 27-36 24 V signal from flow switch
- 37-38 Output signal 0-10 V d.c. to either 3-way valve or frequency transformer for fans
- 39-41 Possibility of connecting an external display type EKA 163 for display of Pc
- 42-44 Possibility of connecting an external display type EKA 164 for operation and temperature display
- 45-46 DI1 - Contact function for alarm signal
- 45-47 DI2 - Contact function for alarm signal
- 48-49 DI3 - Contact function for alarm signal
- 48-50 HP safety - contact function for receiving of high pressure-safety signal
- 51-52 Heat recovery - Contact function for receive of signal to start of heat recovery
- 51-53 S7 sensor. Sensor signal from AKS 11, AKS 12 or EKS 111
- 54-55 Sc3 sensor. Sensor signal from AKS 11, AKS 12 or EKS 111
- 54-56 S8 sensor. Sensor signal from AKS 11, AKS 12 or EKS 111
- 57-58 Signal for displacement of reference. 0-10 V d.c.
- 60-62 Condenser pressure. Voltage signal from AKS 32R.

Data communication

- 25-26 Mount only, if a data communication module has been mounted.
- For Ethernet communication the plug connection RJ45 must be used. (LON FTT10 can also be connected in this way.
- It is important that the installation of the data communication cable be done correctly. Cf. separate literature No. RC8AC.

Common Pc signal

- If AK-PC 420 is used together with another control for compressors, e.g.:
- AK-PC 530
 - AK-PC 730
 - AK-PC 840
 - AK-CH 650
- the same AKS 32R can emit a signal to both controls. But in this case separate 24 V power supplies must be used for the two controllers. In addition to this, the safety limit for "high condensation pressure" is set at the same value in the two controllers.

Data

Supply voltage	24 V a.c. +/-15% 50/60 Hz, 5 VA	
Input signal	1 pcs. pressure transmitter type AKS 32R	
	3 pcs. temperature sensor input for PT 1000 ohm/0°C or PTC 1000 ohm/25°C	
	External reference signal: 0-10 V d.c.	
Digital input from contact function.	1 pcs. for Start/stop of regulation	
	8 pcs. for monitoring of safety circuits	
	3 pcs. for alarm function	
	1 pcs. for start of heat recovery	
Relay output for fans	8 pcs. SPST	AC-1: 3 A (ohmic) AC-15: 2 A (inductive)
Relay output for twin pump	2 pcs. SPST	
Relay output heat recovery	1 pcs. SPST	
Alarm relay	1 pcs. SPDT	AC-1: 6 A (ohmic) AC-15: 3 (inductive)
Voltage output	0-10 V d.c.	
Display outputs	EKA 163	Pc display
	EKA 164	Operation, S7 display
Data communication	Possible to connect a data communication module	
Environments	0 - 55°C, during operation	
	-40 - 70°C, during transport	
	20 - 80% Rh, not condensing	
	No shock influence / vibrations	
Enclosure	IP 20	
Weight	0.4 kg	
Mounting	DIN rail or on wall	
Terminals	max. 2.5 mm ² multicore	
Approvals	EU Low voltage Directive and EMC demands re CE-marking complied with. LVD-tested acc. to EN 60730-1 and EN 60730-2-9 EMC-tested acc. to EN61000-6-2 and 3	

Pressure transmitter / temperature sensor

Please refer to catalogue RK0YG...

Ordering

Type	Function	Ordering
AK-PC 420	Capacity controller for dry cooler	084B8008
EKA 163B	Display unit	084B8574
EKA 164B	Display unit with operation buttons	084B8575
	Cable for display unit 2 m, 1 pcs.	084B7298
	Cable for display unit 6 m, 1 pcs.	084B7299
EKA 174	Data communication module, LON RS 485 (with galvanic separation)	084B7124
EKA 178B	Data communication module, MOD-bus (with galvanic separation)	084B8571

Montage

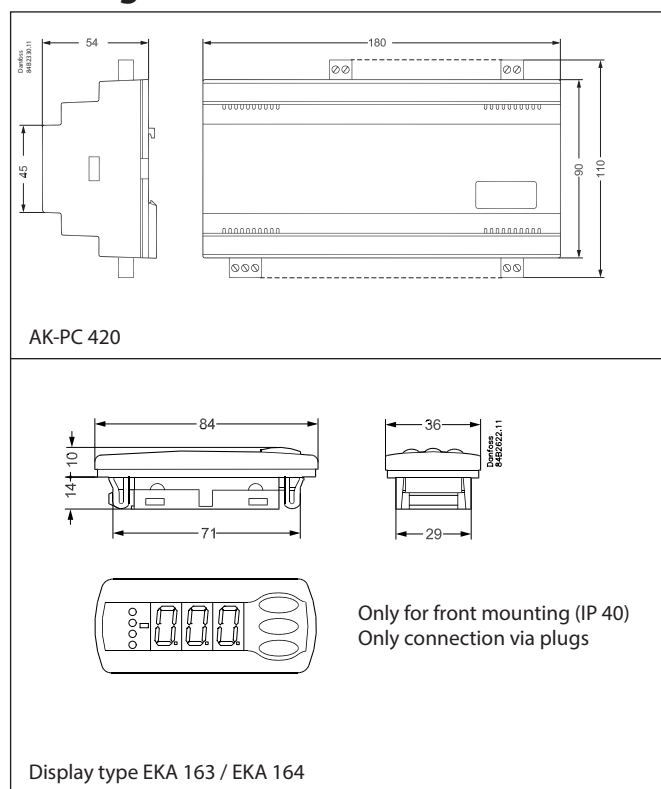

Installation considerations

Accidental damage, poor installation, or site conditions, can give rise to malfunctions of the control system, and ultimately lead to a plant breakdown.

Every possible safeguard is incorporated into our products to prevent this. However, a wrong installation, for example, could still present problems. Electronic controls are no substitute for normal, good engineering practice.

Danfoss will not be responsible for any goods, or plant components, damaged as a result of the above defects. It is the installer's responsibility to check the installation thoroughly, and to fit the necessary safety devices.

Special reference is made to the necessity of signals to the controller when the compressor is stopped and to the need of liquid receivers before the compressors.

Your local Danfoss agent will be pleased to assist with further advice, etc.

Appendix - Reference and regulation

The regulation functions are explained in more detail below.

With parameter r33 Ctrl. Mode it is possible to choose between six different forms of regulation.

As a starting point 1, 2 or 5 are recommended. However, if the system is unstable it might be necessary to switch to 3, 4 or 6.

r33	Ctrl. type	Reference		Reference delimitation	
		No heat recovery	Heat recovery	Minimum	Maximum
1	PI	r28 SP+Ext. Ref	r64 SP+Ext. Ref	r31 Ref Min.	r30 Ref Max.
2	PI	Sc3+Min.tm	r64 SP+Ext. Ref	r31 Ref Min.	r30 Ref Max.
3	P	r28 SP+Ext. Ref	r64 SP+Ext. Ref	r31 Ref Min.	r30 Ref Max.
4	P	Sc3+Min.tm	r64 SP+Ext. Ref	r31 Ref Min.	r30 Ref Max.
5	PI	r28 SP+Ext. Ref	r64 SP+Ext. Ref	Sc3+Min. tm K	r30 Ref Max.
6	P	r28 SP+Ext. Ref	r64 SP+Ext. Ref	Sc3+Min. tm K	r30 Ref Max.

Important setting to avoid unwanted alarms
 When r33 = 1,2 or 5:
 Pc Ref max. must be set at least 5 K below Pc max. (A30).
 When r33 = 3, 4 or 6:
 Pc Ref max. must be set at least ("n04 Valve Xp" + "n60 Fan Xp" +5) K below Pc max. (A30).

1. PI regulation. Fixed reference i.e. constant condensing pressure.
2. PI regulation. Floating reference with outdoor temperature Sc3 i.e. variable condensing pressure.
3. As "1", but with P regulation. A higher condensing pressure than indicated by the reference must be accepted here.
4. As "2", but with P regulation. A higher condensing pressure than indicated by the reference must be accepted here.
5. and 6. As 1 and 3, but with outdoor temperature dependent min. reference.

The different regulation modes are as follows:

(For the sake of simplicity, in the example no consideration is given to any possible overriding with external reference signal 0-10 V.)

1. PI regulation with fixed reference

Heat recovery = on

In PI regulation the controller will make sure that the actual regulation temperature deviates as little as possible from the actual reference. The reference at any time, on the basis of which the controller regulates, can be seen in "r29". During normal regulation the setting "r28 SetPoint" is used as a reference. For heat recovery the reference is changed to R64 Heat SP °C, and r30 is raised to 99.9°C

Raising/lowering of the reference takes place via a ramp function defined at "r65 RefRamp". The capacity of the three-way valve is controlled via regulation parameters "n04 Valve Xp" and "n05 valve Tn s", and the fans are controlled via regulation parameters "n60 Fan Xp" and "n61 Fan Tn s".

2. PI regulation with floating reference

Heat recovery = on

In PI regulation the controller will make sure that the actual regulation temperature deviates as little as possible from the actual reference. The reference is at a fixed value (r56 Min tm K) above the actual measured outdoor temperature Sc3 and can be seen in "r29 Ref °C". If the outdoor temperature falls one degree, the reference will also fall one degree. For heat recovery the reference is changed to r64 Heat SP °C, and r30 is raised to 99.9°C

Raising/lowering of the reference takes place via a ramp function defined at "r65 RefRamp". If there is a sensor failure on the outdoor temperature sensor, the reference will switch to the setting of "r28 SetPoint". The capacity of the three-way valve is controlled via regulation parameters "n04 Valve Xp" and "n05 valve Tn s", and the fans are controlled via regulation parameters "n60 Fan Xp" and "n61 Fan Tn s".

3. P regulation with fixed setting

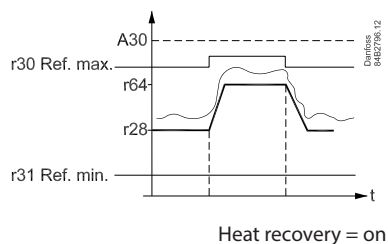

As point 1, but with P regulation the actual regulation temperature will always deviate in relation to the actual reference. The reason is that the actual cut-in capacity is solely dependent on how far the measured regulation temperature is from the actual reference. The capacity of the three-way valve is controlled via proportional band "n04 Valve Xp" and the fans are controlled via proportional band "n60

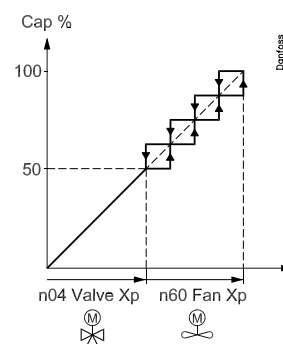

Fan Xp". This means that the three-way valve will be fully open when the temperature is "n04 S7/Pc Xp" over the actual reference, and the fans will provide full capacity when the temperature is "n04 S7/Pc Xp" + "n60 S8 Xp" above the actual reference.

The cutin and cutout of fans are shown in the drawing. If the entire fan capacity is controlled by speed regulation, the capacity will be indicated on the broken line.

4. P regulation with floating reference

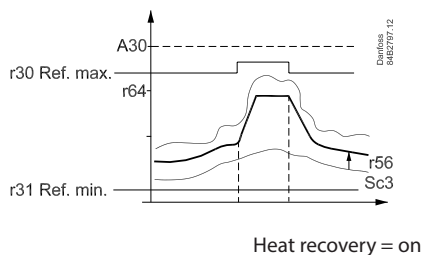

As point 2, but with P regulation the actual regulation temperature will always deviate in relation to the actual reference. The reason is that the actual cut-in capacity is solely dependent on how far the measured regulation temperature is from the actual reference. The capacity of the three-way valve is controlled via proportional band "n04 Valve Xp" and the fans are controlled via proportional band "n60

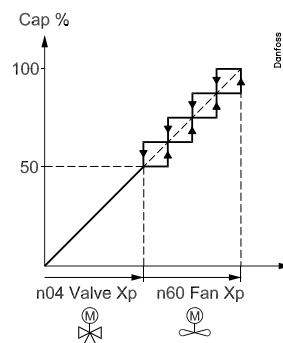

Fan Xp". This means that the three-way valve will be fully open when the temperature is "n04 S7/Pc Xp" over the actual reference, and the fans will provide full capacity when the temperature is "n04 S7/Pc Xp" + "n60 S8 Xp" above the actual reference.

The cutin and cutout of fans are shown in the drawing. If the fan capacity is controlled by speed regulation, the capacity will be indicated on the broken line.

5. PI regulation with fixed reference and with min. reference which depends on the outdoor temperature

Heat recovery = on

Heat recovery = on

In PI regulation the controller will make sure that the actual regulation temperature deviates as little as possible from the actual reference. The reference at any time, on the basis of which the controller regulates, can be seen in "r29". During normal regulation the setting "r28 SetPoint" is used as a reference. Ref. min. = Sc3 + Min. tm K

For heat recovery the reference is changed to R64 Heat SP °C, and r30 is raised to 99.9°C Raising/lowering of the reference takes place via a ramp function defined at "r65 RefRamp". The capacity of the three-way valve is controlled via regulation parameters "n04 Valve Xp" and "n05 valve Tn s", and the fans are controlled via regulation parameters "n60 Fan Xp" and "n61 Fan Tn s".

6. P regulation with fixed setting and with min. reference which depends on the outdoor temperature

Heat recovery = on

Heat recovery = on

As point 1, but with P regulation the actual regulation temperature will always deviate in relation to the actual reference. The reason is that the actual cut-in capacity is solely dependent on how far the measured regulation temperature is from the actual reference. The capacity of the three-way valve is controlled via proportional band "n04 Valve Xp" and the fans are controlled via proportional band "n60 Ref. min. = Sc3 + Min. tm K

Fan Xp". This means that the three-way valve will be fully open when the temperature is "n04 S7/Pc Xp" over the actual reference, and the fans will provide full capacity when the temperature is "n04 S7/Pc Xp" + "n60 S8 Xp" above the actual reference. The cutin and cutout of fans are shown in the drawing. If the entire fan capacity is controlled by speed regulation, the capacity will be indicated on the broken line.