

ENGINEERING
TOMORROW

Danfoss

Design Guide

Monitoring unit with COP calculation

AK-LM 350

ADAP-KOOL® Refrigeration control systems

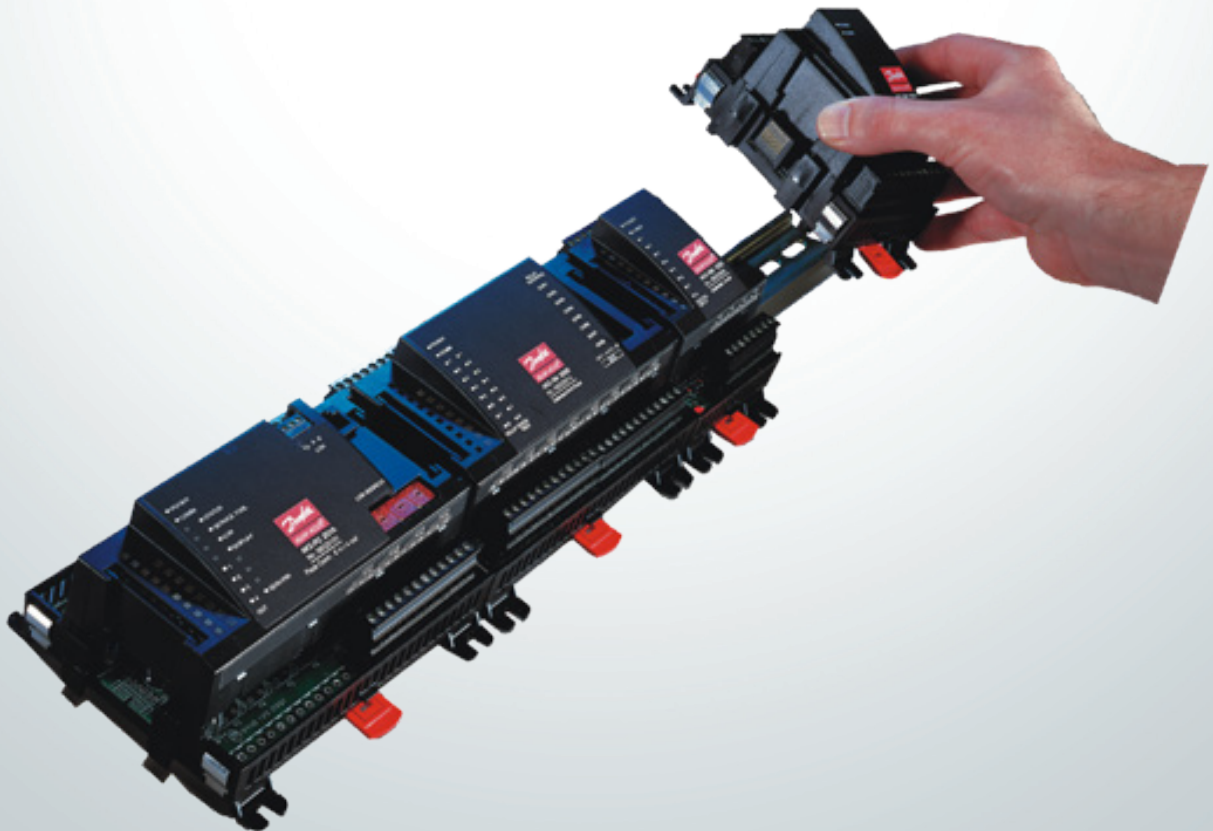

Contents

1. Introduction	3	4. Configuration and operation	43
Application	3	Configuration	45
Principles	4	Connect PC	45
2. Design of a controller	7	Authorization	46
Module survey	8	Unlock the configuration of the controllers	47
Common data for modules	10	System setup	48
Controller	12	Set plant type	49
Extension module AK-XM 101A	14	Utility meters	50
Extension module AK-XM 102A / AK-XM 102B	16	Thermostat functions	51
Extension module AK-XM 204A / AK-XM 204B	18	Pressostat functions	51
Extension module AK-XM 205A / AK-XM 205B	20	Voltage controls	52
Extension module AK-XM 107A	22	Digitale alarms	52
Extension module AK-OB 101A	24	COP calculation	53
Transformer module AK-PS 075 / 150	25	Configuration of inputs and outputs	54
Communication module AK-CM 102	26	Set alarm priorities	56
Preface to design	28	Check of settings	58
Functions	28	Lock configuration	61
Connections	29	Check configuration	62
Limitations	29	Check of connections	63
Design of a monitoring	30	Installation in network	64
Procedure:	30	First start of control	65
Sketch	30	Start the control	66
Monitoring unit	31	Setup logs	67
Connections	32	5. Regulating functions	69
Planning table	33	Monitoring functions	70
Length	34	Miscellaneous	73
Linking of modules	34	Alarm texts	75
Determine the connection points	35	6. Appendix, COP signals	76
Connection diagram	36	CO ₂ Booster	76
Supply voltage	37	CO ₂ Booster HR	76
Ordering	38	CO ₂ Booster HR Brine	76
3. Mounting and wiring	39	Cascade	77
Mounting	40	Single stage	77
Mounting of extension module on the basic module	40		
Wiring	41		

1. Introduction

Application

AK-LM 350 is a complete monitoring unit with the option of regulation functions via relay switches.

The monitoring unit is used to detect temperature, pressure, functions etc. in and around appliance cases and cold rooms for commercial and industrial cooling.

COP calculation can be made on the following systems:

- CO₂ booster
- CO₂ booster with heat recovery
- CO₂ booster with heat recovery and brine
- Cascade plant
- Single stage

The monitoring unit is equipped with data communication and is operated via a PC.

The COP calculation requires a 0-10 V signal that indicates how much of the compressor capacity is connected.

This signal can be retrieved from the compressor controller, if it is one of the following types:

- AK-PC 772
- AK-PC 781, version 4 or newer (version 4 = January 2013)
- AK-PC 783.

Functions

Temperature

- Temperature detection
- Temperature monitoring with alarm function
- Extension of the alarm delay when a defrost signal (DI) is received
- Interruption of alarm monitoring when a switch signal (DI) is received
- Temperature control with relay function

Pressure

- Pressure detection
- Pressure monitoring with alarm function
- Pressure control with relay function

Voltages of 0-10 V

- Voltage detection
- Voltage monitoring with alarm function
- Voltage monitoring with relay function

On/Off signals

- Detection of switch signals
- Alarm function with delay + relay function, if applicable
- The switch signal can be inverted
- Hour counter for On time
- Counter for number of changes

Pulse signals

- Registration of electricity, water, gas, etc.
- Energy reading
- Energy reading in a set synchronisation period
- Energy reading in a period between synchronisation pulses
- Receiving synchronisation signal

COP calculation

- COP for MT and LT
- Etas for MT and LT
- Refrigeration capacity for MT and LT
- Heat recovery
- Heat loss
- COSP for the whole system

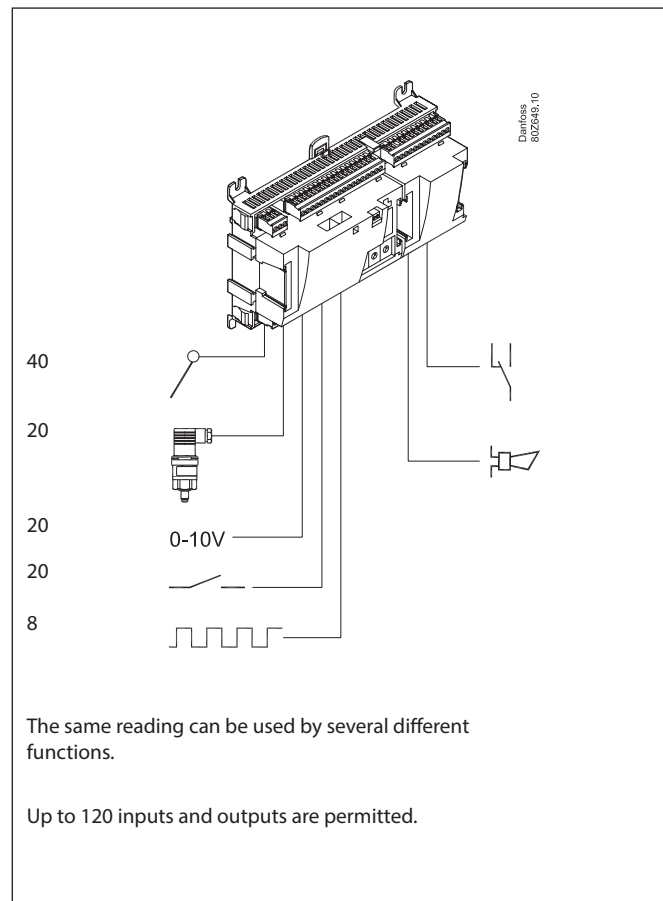

Alarm relay

- Two alarm relays that are enabled on different alarm priorities

Data communication

- Connection to system manager or gateway
- Monitoring and data collection
- Customised alarm texts

Principles

The great advantage of this series of controllers is that it can be extended as the size of the plant is increased. It has been developed for refrigeration control systems, but not for any specific application – variation is created through the read-in software and the way you choose to define the connections. It is the same modules that are used for each regulation and the composition can be changed, as required. With these modules (building blocks) it is possible to create a multitude of various kinds of regulations. But it is you who must help adjusting the regulation to the actual needs – these instructions will assist you to find your way through all the questions so that the regulation can be defined and the connections made.

Advantages

- The controller's size can "grow" as systems grow
- The software can be set for one or more regulations
- Several regulations with the same components
- Extension-friendly when systems requirements are changed
- Flexible concept:
 - Controller series with common construction
 - One principle – many regulation uses
 - modules are selected for the actual connection requirements
 - The same modules are used from regulation to regulation

Controller

Danfoss
BDZ92.11

Top part

Bottom part

Extension modules

Danfoss
ADZ93.10

The controller is the cornerstone of the regulation. The module has inputs and outputs capable of handling small systems.

- The bottom part – and hence the terminals – are the same for all controller types.
- The top part contains the intelligence with software. This unit will vary according to controller type. But it will always be supplied together with the bottom part.
- In addition to the software the top part is provided with connections for data communication and address setting.

If the system grows and more functions have to be controlled, the regulation can be extended. With extra modules more signals can be received and more relays cut in and out – how many of them – and which – is determined by the relevant application.

Examples

Danfoss
ADZ93.10

Danfoss
ADZ94.10

A regulation with few connections can be performed with the controller module alone

If there are many connections one or more extension modules have to be mounted

Direct connection

Setup and operation of an AK controller must be accomplished via the "AK-Service Tool" software program.

The programme is installed on a PC, and setup and operation of the various functions are carried out via the controller's menu displays.

Displays

The menu displays are dynamic, so that different settings in one menu will result in different setting possibilities in other menus.

A simple application with few connections will give a setup with few settings.

A corresponding application with many connections will give a setup with many settings.

From the overview display there is access to further displays for the compressor regulation and the condenser regulation.

At the bottom of the display there is access to a number of general functions, such as "overview", "manual operation", "log function", "alarms", and "service" (configuration).

Network linking

The controller can be linked up into a network together with other controllers in an ADAP-KOOL® refrigeration control system.

A gateway type AKA 245, or a system manager type AK-SM 350, AK-SM 720 or AK-SC 355, can be used as a system unit.

After the setup operation can be performed at a distance with, say, our software program type AKM.

Users

The controller comes supplied with several languages, one of which can be selected and employed by the user. If there are several users, they may each have their choice of language. All users must be assigned a user profile which either gives access to full operation or gradually limits the operation to the lowest level that only allows you "to see".

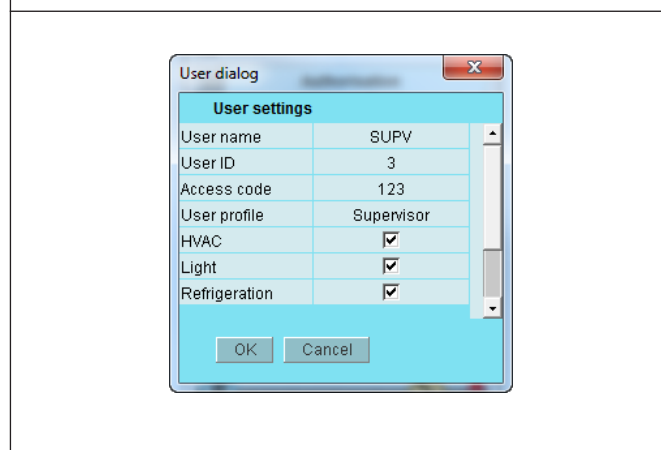
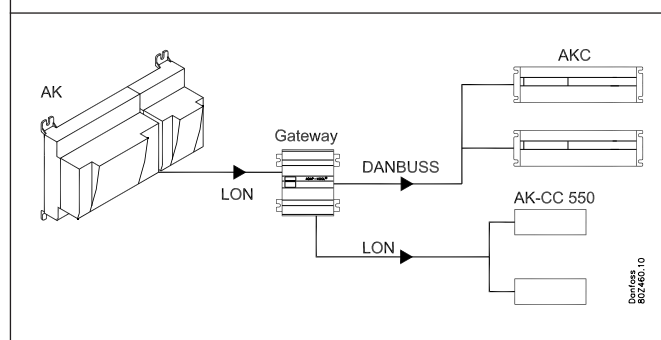
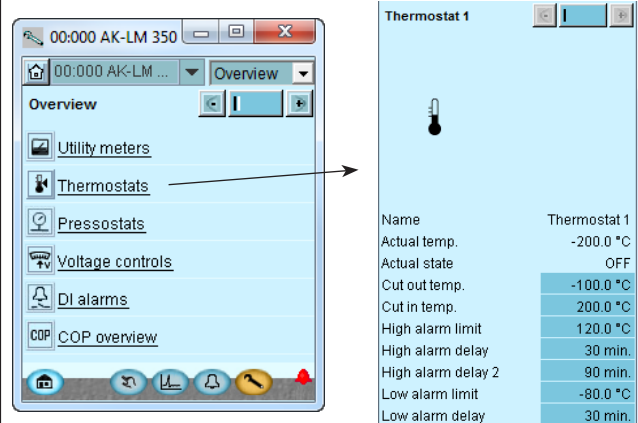
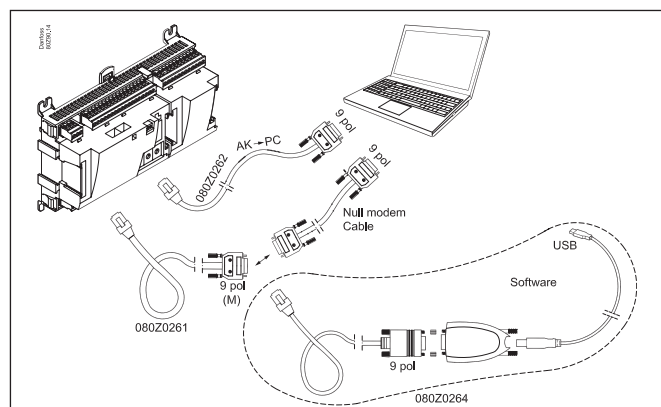

Light-emitting diodes

A number of light-emitting diodes makes it possible to follow the signals that are received and transmitted by the controller.

Log

From the log function you can define the measurements you wish to be shown.

The collected values can be printed, or you may export them to a file. You can open the file in Excel or import in AKM. (The log function is only available via AK-ST 500.)

A log should usually be created on the system unit. The system unit has a larger memory and can contain more data.

If you are in a service situation you can show measurements in a trend function. The measurements are then made real-time and displayed instantly.

Alarm

The display gives you an overview of all active alarms. If you wish to confirm that you have seen the alarm you can cross it off in the acknowledge field.

If you want to know more about a current alarm you can click on it and obtain an information display on the screen.

A corresponding display exists for all earlier alarms. Here you can upload information if you need further details about the alarm history.

2. Design of a controller

This section describes how the monitoring unit is designed.

The controller in the system is based on a uniform connection platform where any deviations from regulation to regulation is determined by the used top part with a specific software and by which input and output signals the relevant application will require. If it is an application with few connections, the controller module (top part with belonging bottom part) may be sufficient. If it is an application with many connections it will be necessary to use the controller module plus one or more extension modules.

This section will give you a survey of possible connections plus assistance in selecting the modules required by your actual application.

Module survey

- Controller module – capable of handling minor plant requirements.
- Extension modules. When the complexity becomes greater and additional inputs or outputs are required, modules can be attached to the controller. A plug on the side of the module will transmit the supply voltage and data communication between the modules.
- Top part
The upper part of the controller module contains the intelligence. This is the unit where the regulation is defined and where data communication is connected to other controllers in a bigger network.
- Connection types
There are various types of inputs and outputs. One type may, for example, receive signals from sensors and switches, another may receive a voltage signal, and a third type may be outputs with relays etc. The individual types are shown in the table below.
- Optional connection
When a regulation is planned (set up) it will generate a need for a number of connections distributed on the mentioned types. This connection must then be made on either the controller module or an extension module. The only thing to be observed is that the types must not be mixed (an analog input signal must for instance not be connected to a digital input).
- Programming of connections
The controller must know where you connect the individual input and output signals. This takes place in a later configuration where each individual connection is defined based on the following principle:
 - to which module
 - at which point ("terminals")
 - what is connected (e.g. pressure transmitter/type/pressure range)

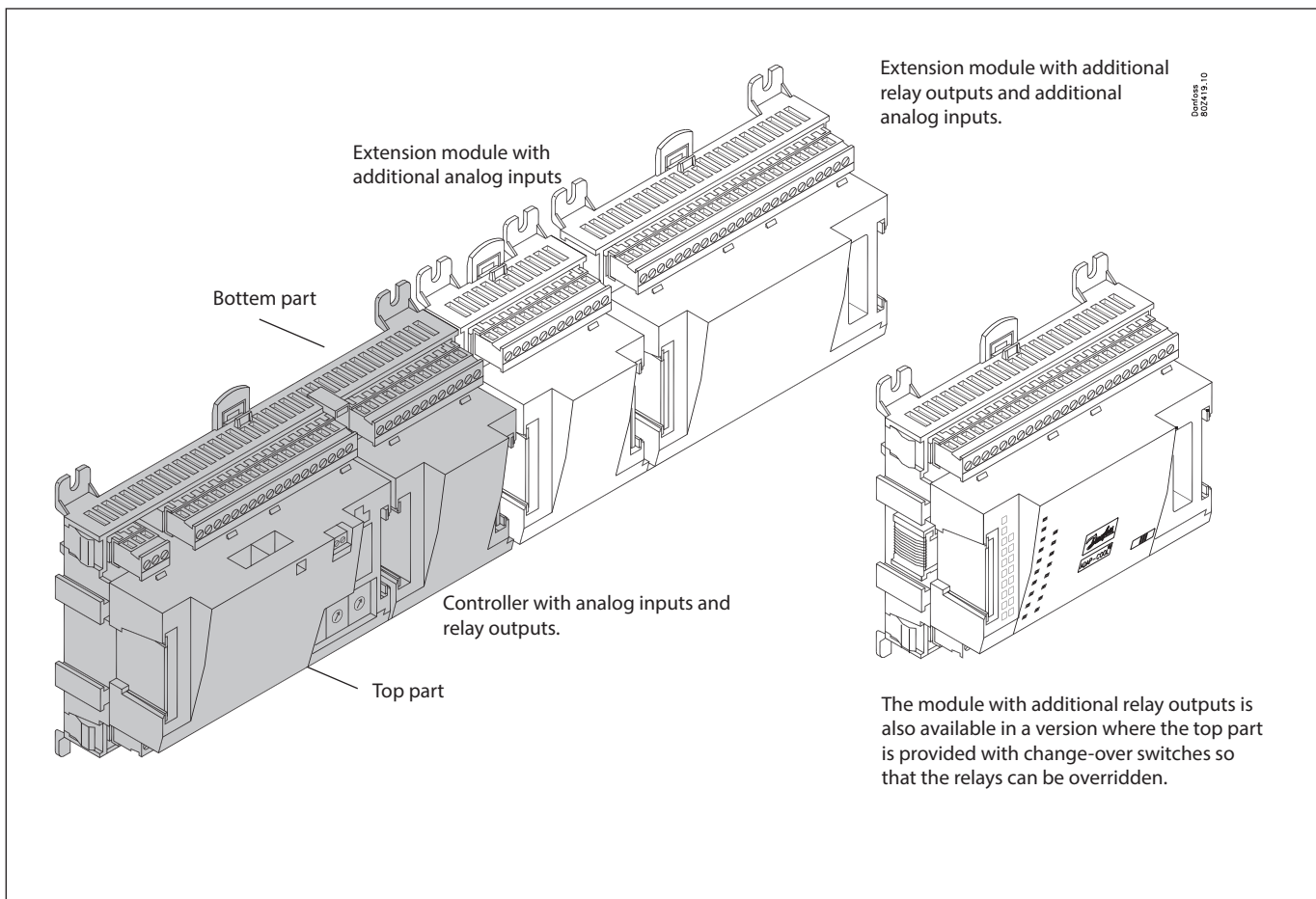

1. Controller

Type	Function	Application
AK-LM 350	Monitoring unit with COP calculation	Monitoring of temperatures, pressure, voltage etc.

2. Extension modules and survey of inputs and outputs

Type	Analog inputs	On/Off outputs		On/off supply voltage (DI signal)			Module with switches
	For sensors, pressure transmitters etc.	Relay (SPDT)	Solid state	Low voltage (max. 80 V)	High voltage (max. 260 V)	Pulse counter Low voltage (max 30 V)	For override of relay outputs
Controller	11	4	4	-	-	-	-

Extension modules

AK-XM 101A	8						
AK-XM 102A				8			
AK-XM 102B					8		
AK-XM 204A		8					
AK-XM 204B		8					x
AK-XM 205A	8	8					
AK-XM 205B	8	8					x
AK-XM 107A						4 (8)	

3. AK operation and accessories

Type	Function	Application
Operation		
AK-ST 500	Software for operation of AK controllers	AK-operation
-	Cable between PC and AK controller	AK - Com port
-	Cable between zero modem cable and AK controller / Cable between PDA cable and AK controller	AK - RS 232
-	Cable between PC and AK controller	AK - USB
Accessories		
Transformer module 230 V / 115 V to 24 V		
AK-PS 075	18 VA, 24 V d.c.	Supply for controller
AK-PS 150	36 VA, 24 V d.c.	
Accessories		
Real time clock for use in controllers that require a clock function, but are not wired with data communication.		
AK-OB 101A	Real time clock with battery backup.	To be mounted in an AK controller
Accessories		
Communication modules for controllers where modules cannot be connected continuously		
AK-CM 102	Communication module	Data communication for external extension modules

On the following pages there is data specific to each module.

Common data for modules

Supply voltage	24 V d.c./a.c. +/- 20%	
Power consumption	AK-__ (controller)	8 VA
	AK-XM 101, 102, 107	2 VA
	AK-XM 204, 205	5 VA
Analog inputs	Pt 1000 ohm /0°C	Resolution: 0.1°C Accuracy: +/- 0.5°C (between -50°C and +50°C)
	Pressure transmitter type AKS 32R / AKS 2050/ AKS 32 (1-5 V)	Resolution: 1 mV Accuracy +/- 10 mV Max. connection of 5 pressure transmitters on one module
	Other pressure transmitter: Ratiometric signal Min. and max. pressure must be set Min and max. voltage must be set	
	Voltage signal 0-10 V	
	Contact function (On/Off)	On at R < 20 ohm Off at R > 2K ohm (Gold -plated contacts not necessary)
On/off supply voltage inputs	Low voltage 0 / 80 V a.c./d.c.	Off: U < 2 V On: U > 10 V
	High voltage 0 / 260 V a.c.	Off: U < 24 V On: U > 80 V
Relay outputs SPDT	AC-1 (ohmic)	4 A
	AC-15 (inductive)	3 A
	U	Min. 24 V Max. 230 V Low and high voltage must not be connected to the same output group
Solid state outputs	Can be used for loads that are cut in and out frequently, e.g.: rail heat, fans and AKV valve	Max. 240 V a.c. , Min. 48 V a.c. Max. 0.5 A, Leak < 1 mA Max. 1 AKV
Ambient temperature	During transport	-40 to 70°C
	During operation	-20 to 55°C, 0 to 95% RH (non condensing) No shock influences / vibrations
Enclosure	Material	PC / ABS
	Density	IP10 , VBG 4
	Mounting	For mounting on panel wall or DIN rail
Weight with screw terminals	Modules in 100- / 200- / controller-series	Ca. 200 g / 500 g / 600 g
Approvals	EU low voltage directive and EMC requirements are complied with	LVD tested according to EN 60730 EMC tested Immunity according to EN 61000-6-2 Emission according to EN 61000-6-3
	UL 873,  us	UL file number: E166834 for XM modules UL file number: E31024 for LM modules

The mentioned data applies to all modules.

If data is specific, this is mentioned together with the module in question.

Dimensions

- The module dimension is 72 mm.
- Modules in the 100-series consist of one module
- Modules in the 200-series consist of two modules
- Controllers consist of three modules
- The length of an aggregate unit = $n \times 72 + 8$

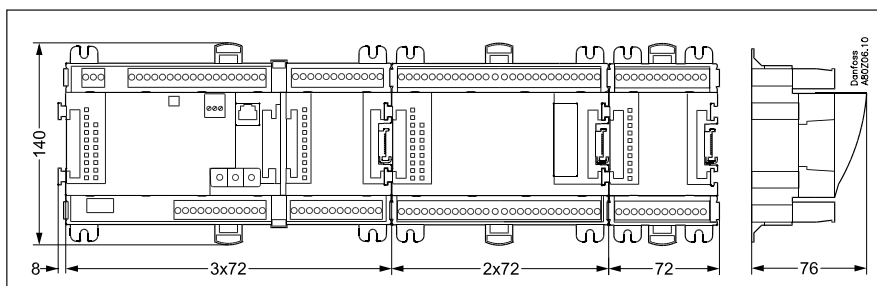

Controller

Function

There are several controllers in the series. The function is determined by the programmed software, but outwardly the controllers are identical – they all have the same connection possibilities:

- 11 analog inputs for sensors, pressure transmitters, voltage signals and contact signals.
- 8 digital outputs, with 4 Solid state outputs and 4 relay outputs

Supply voltage

24 V a.c. or d.c. to be connected to the controller.

The 24 V must **not** be retransmitted and used by other controllers as it is not galvanically separated from inputs and outputs. In other words, you **must** use a transformer for each controller. Class II is required. The terminals must **not** be earthed.

The supply voltage to any extension modules is transmitted via the plug on the right-hand side.

The size of the transformer is determined by the power requirement of the total number of modules.

The supply voltage to a pressure transmitter can be taken either from the 5 V output or from the 12 V output depending on transmitter type.

Data communication

If the controller is to be included in a system, communication must take place via the LON connection. The installation has to be made as mentioned in the separate instructions for LON communication.

Address setting

When the controller is connected to a gateway type AKA 245, the controller's address must be set between 1 and 119. (If it is a system manager AK-SM .., then 1-200).

Service PIN

When the controller is connected to the data communication cable the gateway must have knowledge of the new controller. This is obtained by pushing the key PIN. The LED "Status" will flash when the gateway sends an acceptance message.

Operation

The configuration operation of the controller must take place from the software programme "Service Tool". The program must be installed on a PC, and the PC must be connected to the controller via the network plug on the front of the unit.

Light-emitting diodes

There are two rows with LED's. They mean:

Left row:

- Voltage supply to the controller
- Communication active with the bottom PC board (red = error)
- Status of outputs DO1 to DO8

Right row:

- Software status (slow flash = OK)
- Communication with Service Tool
- Communication on LON
- Communication with AK-CM 102
- Alarm when LED flashes
- 2 LED's that are not used
- "Service Pin" switch has been activated

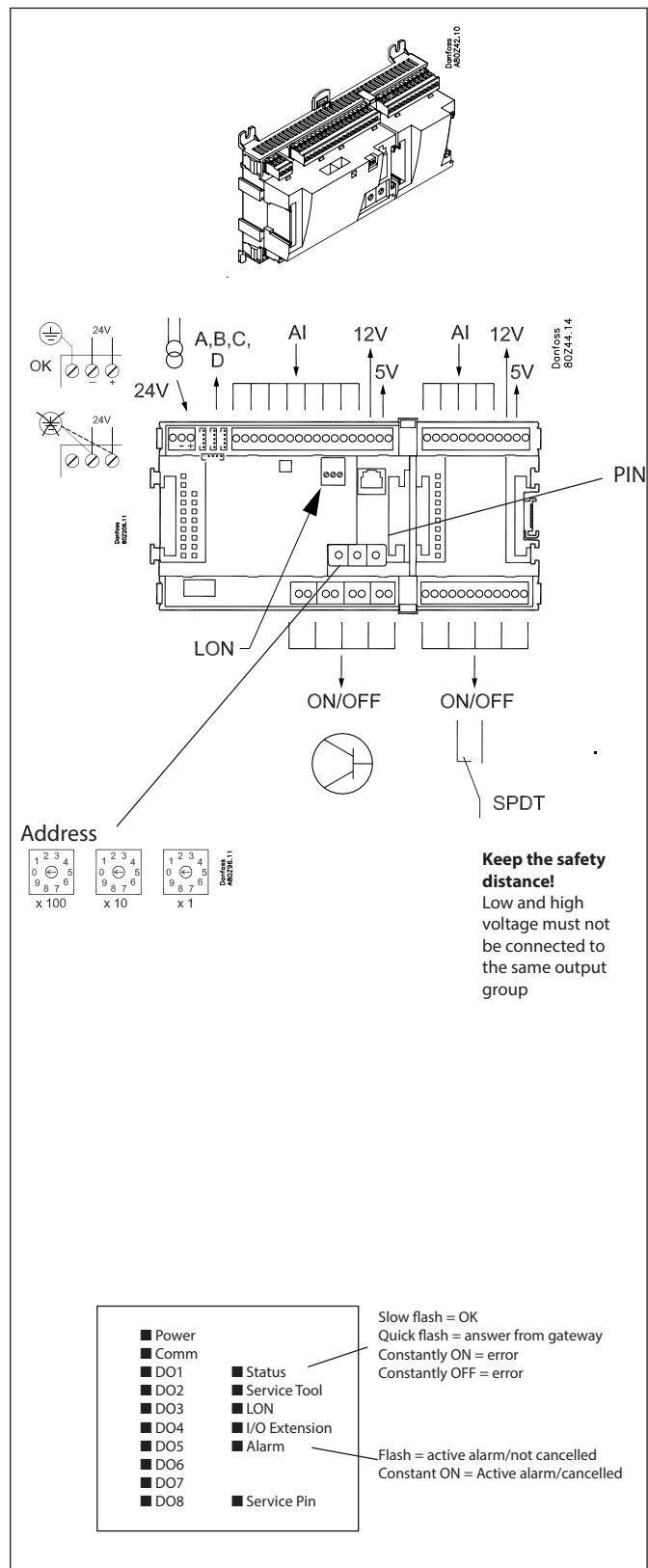

Point

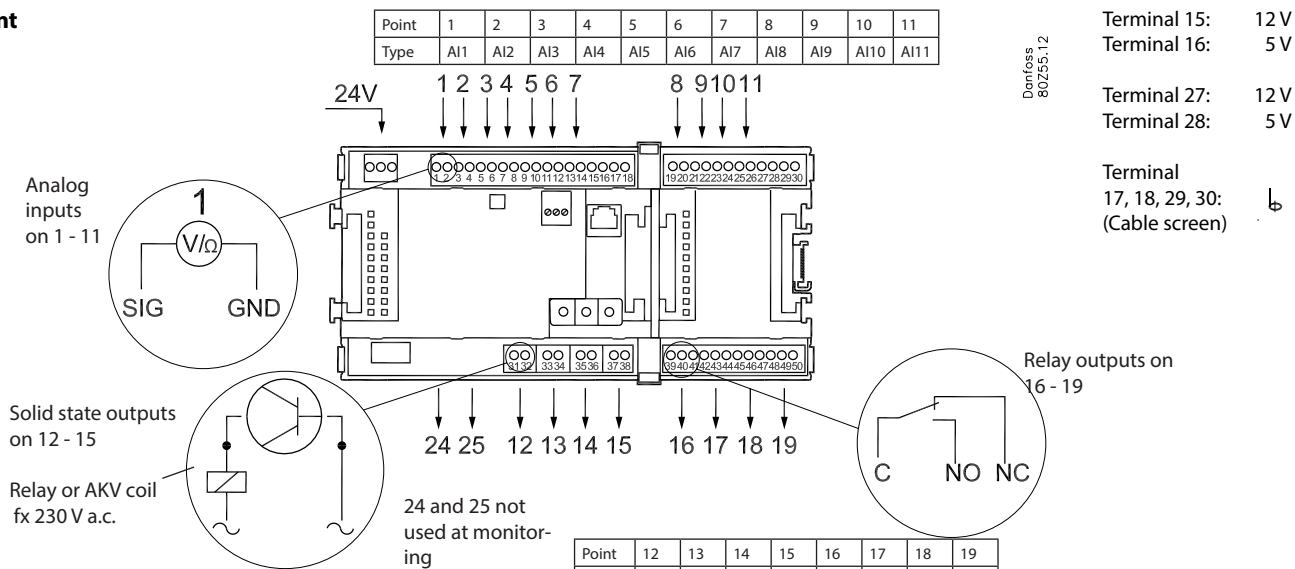

Point	1	2	3	4	5	6	7	8	9	10	11
Type	AI1	AI2	AI3	AI4	AI5	AI6	AI7	AI8	AI9	AI10	AI11

Danfoss
80255.12

Point	12	13	14	15	16	17	18	19
Type	DO1	DO2	DO3	DO4	DO5	DO6	DO7	DO8

	Signal	Signal type
S Pt 1000 ohm/0°C	SIG GND	Pt 1000
P AKS 32R AKS 32	3: Brown SIG 2: Blue GND 1: Black 5V 3: Brown SIG 2: Black GND 1: Red 12V	AKS 32R -1 - xx bar AKS 32 -1 - zz bar
U	+ SIG - GND	Volt input... 0 - 5V 0 - 10V
On/Off	SIG GND	Active at: Closed / Open
DO	AKV C NO NC	Active at: On / Off

Signal	Module	Point	Terminal	Signal type / Active at
	1	1 (AI 1)	1 - 2	
		2 (AI 2)	3 - 4	
		3 (AI 3)	5 - 6	
		4 (AI 4)	7 - 8	
		5 (AI 5)	9 - 10	
		6 (AI 6)	11 - 12	
		7 (AI 7)	13 - 14	
		8 (AI 8)	19 - 20	
		9 (AI 9)	21 - 22	
		10 (AI 10)	23 - 24	
		11 (AI 11)	25 - 26	
		12 (DO 1)	31 - 32	
		13 (DO 2)	33 - 34	
		14 (DO 3)	35 - 36	
		15 (DO 4)	37 - 38	
		16 (DO 5)	39 - 40 - 41	
		17 (DO 6)	42 - 43 - 44	
		18 (DO 7)	45 - 46 - 47	
		19 (DO 8)	48 - 49 - 50	

Extension module AK-XM 101A

Function

The module contains 8 analog inputs for sensors, pressure transmitters, voltage signals and contact signals.

Supply voltage

The supply voltage to the module comes from the previous module in the row.

Supply voltage to a pressure transmitter can be taken from either the 5 V output or the 12 V output depending on transmitter type.

Light-emitting diodes

Only the two top LED's are used. They indicate the following:

- Voltage supply to the module
- Communication with the controller is active (red = error)

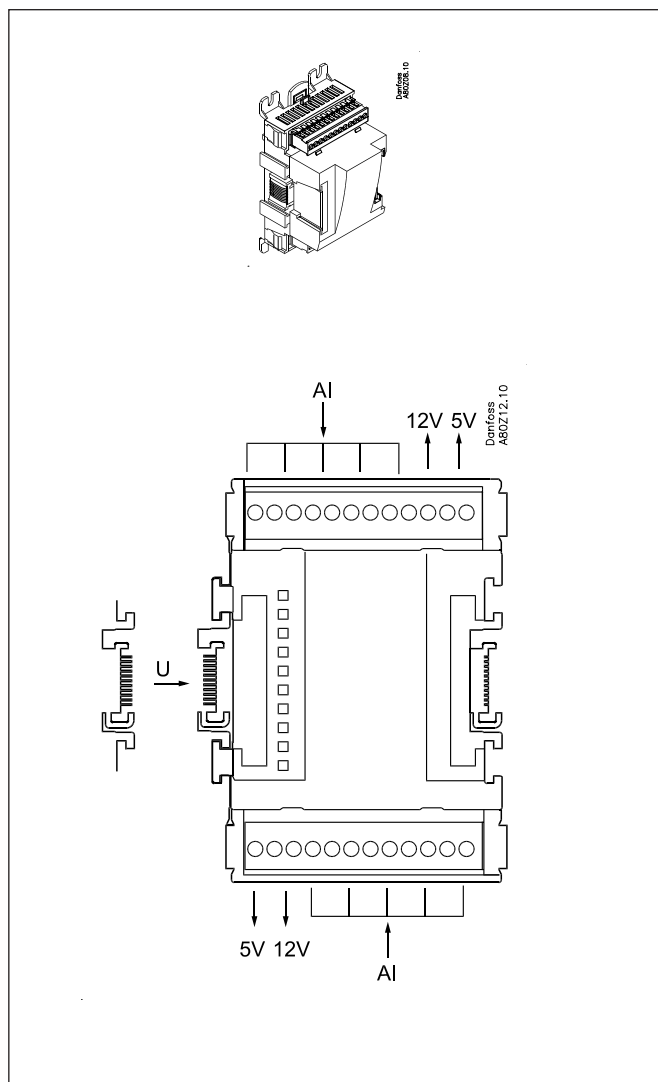

Point

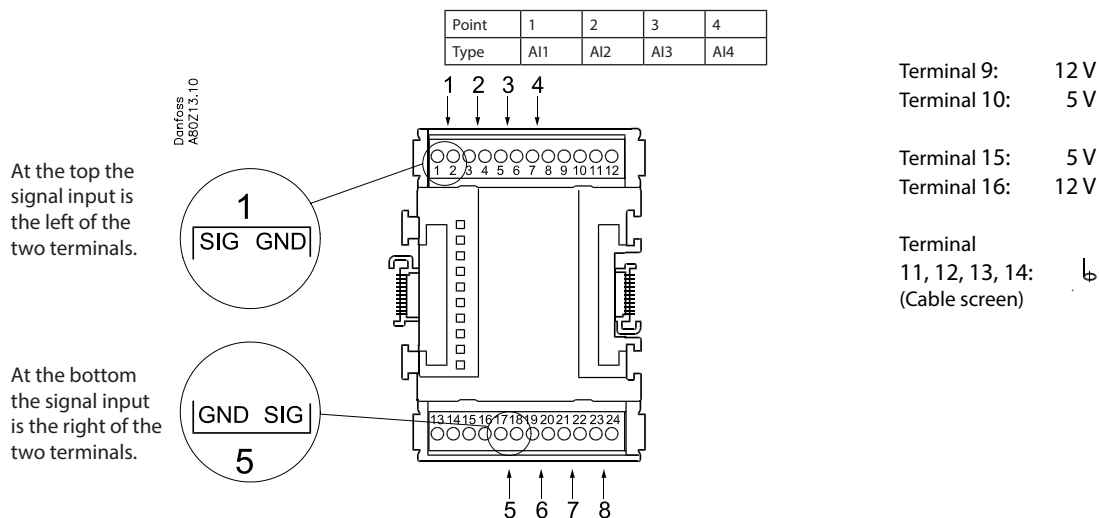

	Signal	Signal type
S Pt 1000 ohm/0°C 	S...	Pt 1000
P AKS 32R AKS 2050 AKS 32 	P...	AKS 32R AKS 2050 -1 - xx bar AKS 32 -1 - zz bar
U 	V...	0 - 5 V 0 - 10 V
On/Off 	Day/ Night Door Defrost	Active at: Closed / Open

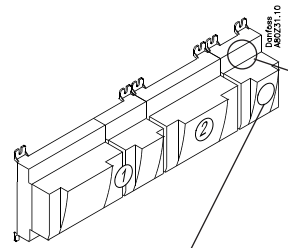

Signal	Module	Point	Terminal	Signal type / Active at
		1 (AI 1)	1 - 2	
		2 (AI 2)	3 - 4	
		3 (AI 3)	5 - 6	
		4 (AI 4)	7 - 8	
		5 (AI 5)	17 - 18	
		6 (AI 6)	19 - 20	
		7 (AI 7)	21 - 22	
		8 (AI 8)	23 - 24	

Extension module AK-XM 102A / AK-XM 102B

Function

The module contains 8 inputs for on/off voltage signals.

Signal

AK-XM 102A is for low voltage signals.

AK-XM 102B is for high voltage signals.

Supply voltage

The supply voltage to the module comes from the previous module in the row.

Light-emitting diodes

They indicate:

- Voltage supply to the module
- Communication with the controller is active (red = error)
- Status of the individual inputs 1 to 8 (when lit = voltage)

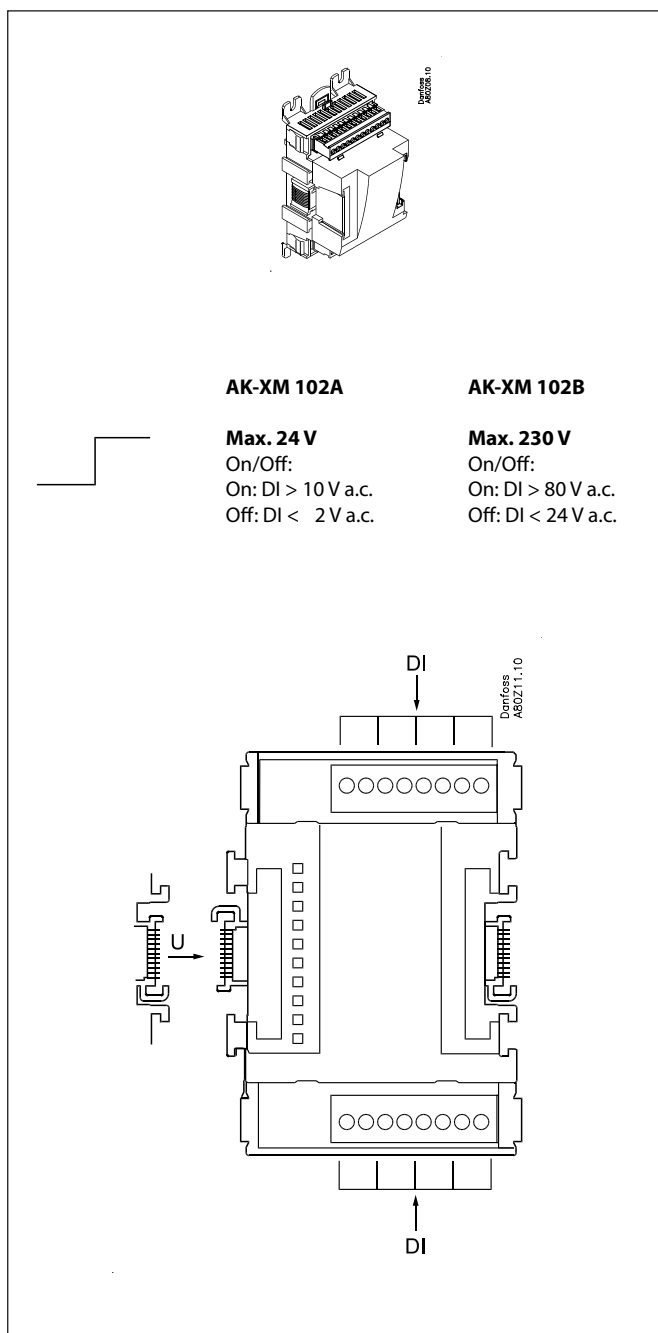

Point

Point	1	2	3	4
Type	DI1	DI2	DI3	DI4

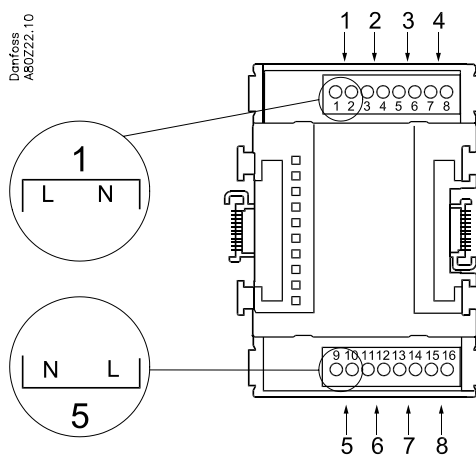

Point	5	6	7	8
Type	DI5	DI6	DI7	DI8

	Signal	Active at
DI		
AK-XM 102A: Max. 24 V AK-XM 102B: Max. 230 V	Day/ Night	Closed (voltage on)
	Door.	/
	Defrost	Open (voltage off)

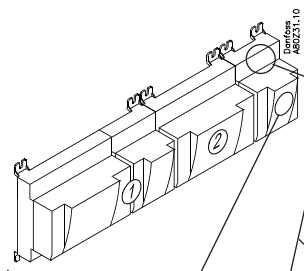

Signal	Module	Point	Terminal	Active at
		1 (DI 1)	1 - 2	
		2 (DI 2)	3 - 4	
		3 (DI 3)	5 - 6	
		4 (DI 4)	7 - 8	
		5 (DI 5)	9 - 10	
		6 (DI 6)	11 - 12	
		7 (DI 7)	13 - 14	
		8 (DI 8)	15 - 16	

Extension module AK-XM 204A / AK-XM 204B

Function

The module contains 8 relay outputs.

Supply voltage

The supply voltage to the module comes from the previous module in the row.

AK-XM 204B only

Override of relay

Eight change-over switches at the front make it possible to override the relay's function.

Either to position OFF or ON.

In position Auto the controller carries out the control.

Light-emitting diodes

There are two rows with LED's. They indicate the following:

Left row:

- Voltage supply to the controller
- Communication active with the bottom PC board (red = error)
- Status of outputs DO1 to DO8

Right row: (AK-XM 204B only):

- Override of relays
 - ON = override
 - OFF = no override

Fuses

Behind the upper part there is a fuse for each output.

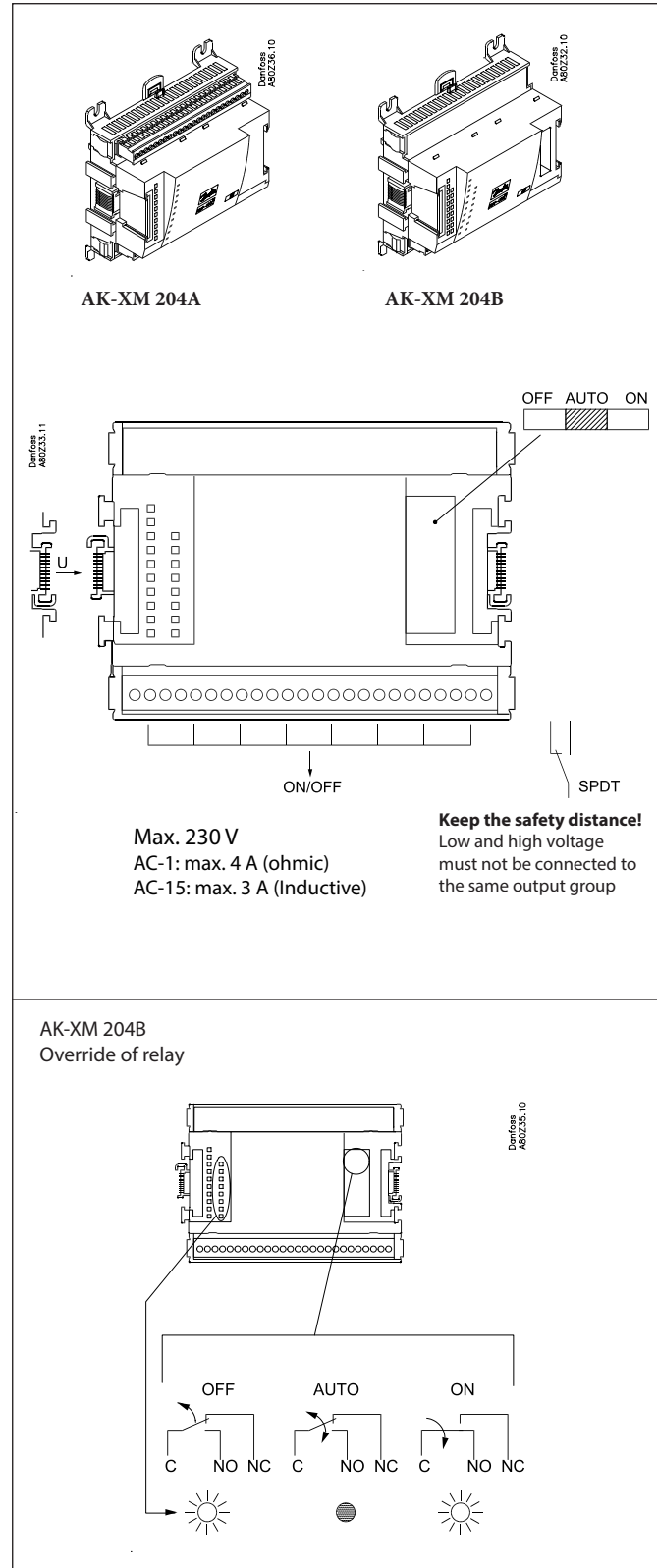

Point

Danfoss
A80Z34.10

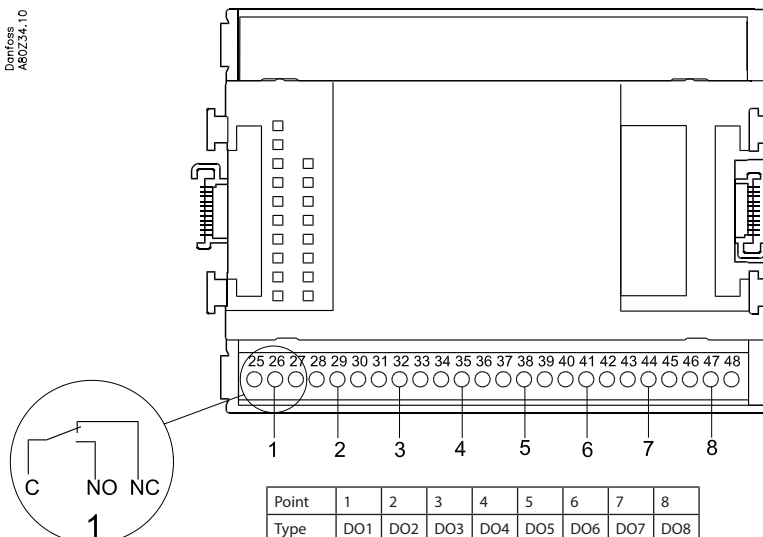

	Signal	Active at
DO	Fan Alarm Light Rail-heat Defrost Night blinds Valves Compressor	On / Off

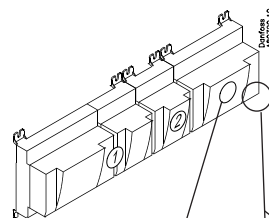

Signal	Module	Point	Terminal	Active at
		1 (DO 1)	25 - 26 - 27	
		2 (DO 2)	28 - 29 - 30	
		3 (DO 3)	31 - 32 - 33	
		4 (DO 4)	34 - 35 - 36	
		5 (DO 5)	37 - 38 - 39	
		6 (DO 6)	40 - 41 - 42	
		7 (DO 7)	43 - 44 - 45	
		8 (DO 8)	46 - 47 - 48	

Extension module AK-XM 205A / AK-XM 205B

Function

The module contains:
 8 analog inputs for sensors, pressure transmitters, voltage signals and contact signals.
 8 relay outputs.

Supply voltage

The supply voltage to the module comes from the previous module in the row.

AK-XM 205B only

Override of relay

Eight change-over switches at the front make it possible to override the relay's function. Either to position OFF or ON. In position Auto the controller carries out the control.

Light-emitting diodes

There are two rows with LED's. They mean:

Left row:

- Voltage supply to the controller
- Communication active with the bottom PC board (red = error)
- Status of outputs DO1 to DO8

Right row: (AK-XM 205B only):

- Override of relays
 ON = override
 OFF = no override

Fuses

Behind the upper part there is a fuse for each output.

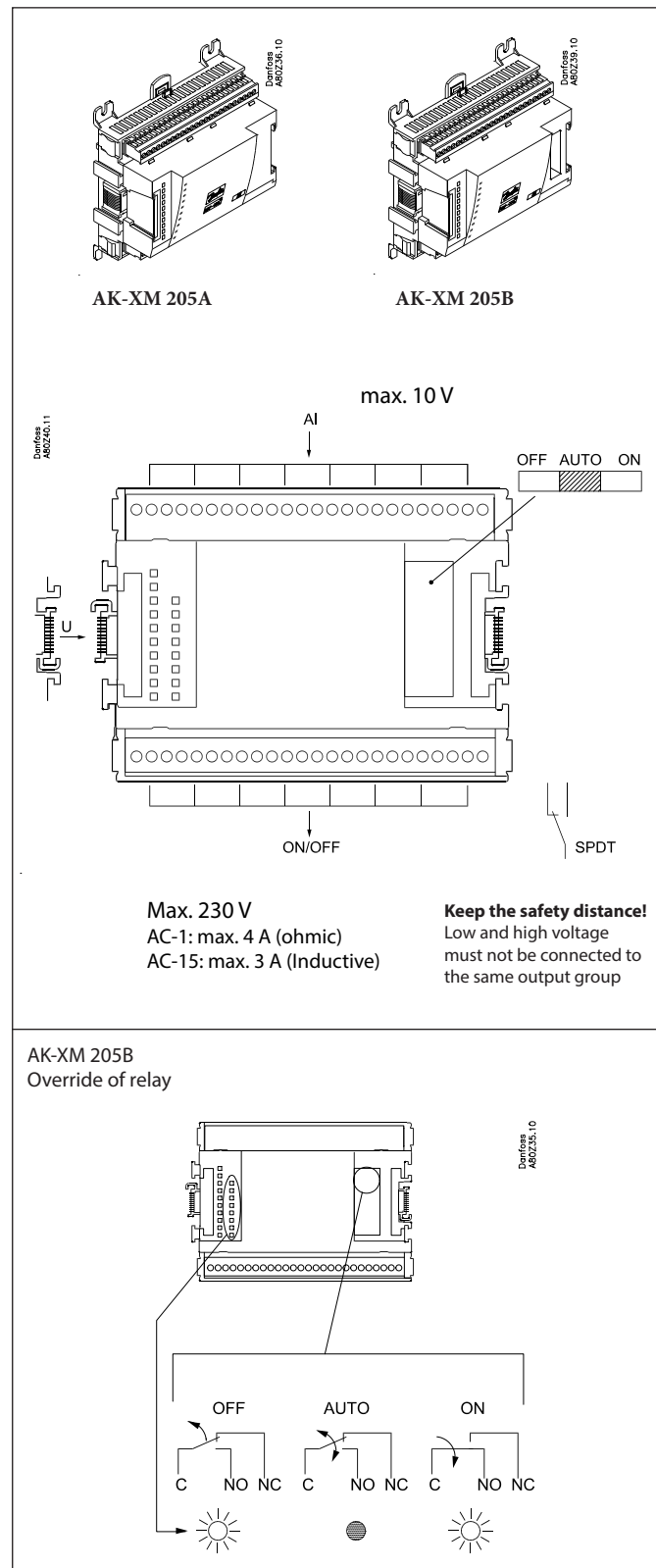

Point

Point	1	2	3	4	5	6	7	8
Type	AI1	AI2	AI3	AI4	AI5	AI6	AI7	AI8

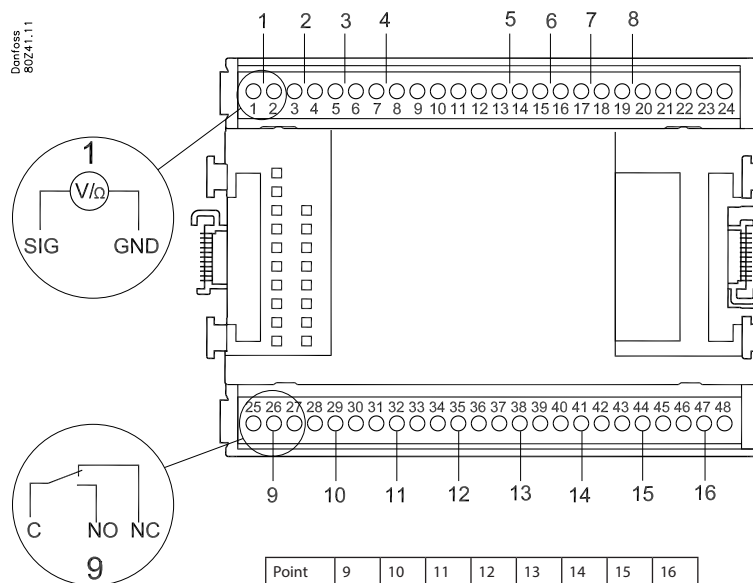

Terminal 9: 12V
Terminal 10: 5V

Terminal 21: 12V
Terminal 22: 5V

Terminal 11, 12, 23, 24: 6 (Cable screen)

Point	9	10	11	12	13	14	15	16
Type	DO1	DO2	DO3	DO4	DO5	DO6	DO7	DO8

	Signal	Signal type
S Pt 1000 ohm/0°C 	S...	Pt 1000
P AKS 32R AKS 2050 AKS 32 	P...	AKS 32R AKS 2050 -1 - xx bar AKS 32 -1 - zz bar
U 	V...	0 - 5 V 0 - 10 V
On/Off 	Day/ Night Door Defrost	Active at: Closed / Open
DO 	Fan Alarm Light Rail heat Defrost Night blinds Valves Compressors	Active at: on / Off

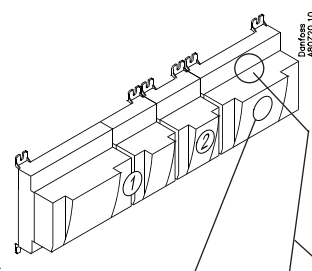

Signal	Module	Point	Terminal	Signal type / Active at
		1 (AI 1)	1 - 2	
		2 (AI 2)	3 - 4	
		3 (AI 3)	5 - 6	
		4 (AI 4)	7 - 8	
		5 (AI 5)	13 - 14	
		6 (AI 6)	15 - 16	
		7 (AI 7)	17 - 18	
		8 (AI 8)	19 - 20	
		9 (DO 1)	25 - 26 - 27	
		10 (DO 2)	28 - 29 - 30	
		11 (DO 3)	31 - 30 - 33	
		12 (DO 4)	34 - 35 - 36	
		13 (DO 5)	37 - 36 - 39	
		14 (DO 6)	40 - 41 - 42	
		15 (DO 7)	43 - 44 - 45	
		16 (DO 8)	46 - 47 - 48	

Extension module AK-XM 107A

Function

The module contains eight inputs for pulse counting. AK-LM 350 can detect signals from 8 pulse signals. As an alternative, the input can be used to register a signal for synchronising or an On/Off signal. (DI function).

Supply voltage

The supply voltage for the module comes from the previous module in the sequence.

LEDs

These indicate the following:

- Voltage of the module
- Communication with the controller is active (red = error)

(There is no LED indication for the individual signal inputs)

Signal

The signal is registered in accordance with DIN 43864.

Rise times and fall times must be less than 5 ms.

On and off times must be greater than 30 ms.

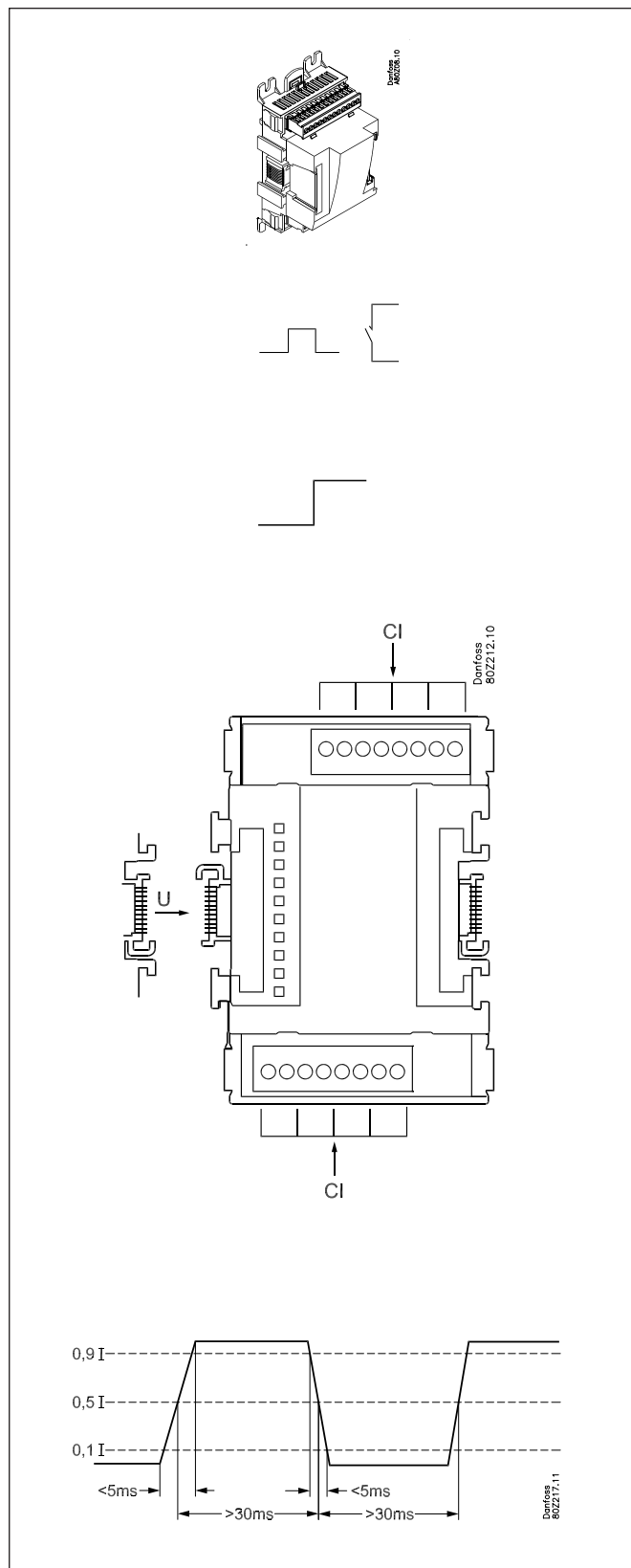

Point

Point	1	2	3	4
Type	CI1	CI2	CI3	CI4

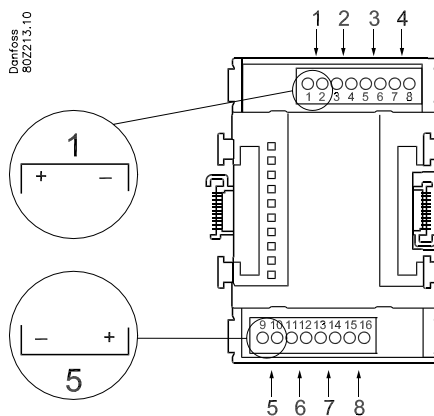

Point	5	6	7	8
Type	CI5	CI6	CI7	CI8

	Signal	Active at
CI		---

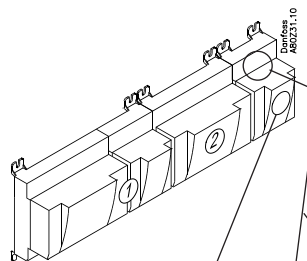

Signal	Module	Point	Terminal	Active at
		1 (CI 1)	1 - 2	---
		2 (CI 2)	3 - 4	---
		3 (CI 3)	5 - 6	---
		4 (CI 4)	7 - 8	---
		5 (CI 5)	9 - 10	---
		6 (CI 6)	11 - 12	---
		7 (CI 7)	13 - 14	---
		8 (CI 8)	15 - 16	---

Extension module AK-OB 101A

Function

The module is a real time clock module with battery backup.

The module can be used in controllers that are not linked up in a data communication unit together with other controllers. The module is used here if the controller needs battery backup for the following functions

- Clock function
- Fixed times for day/night change-over
- Fixed defrost times
- Saving of alarm log in case of power failure
- Saving of temperature log in case of power failure

Connection

The module is provided with plug connection.

Placing

The module is placed on the PC board inside the top part.

Point

No point for a clock module to be defined – just connect it.

Working life of the battery

The working life of the battery is several years – even if there are frequent power failures.

An alarm is generated when the battery has to be replaced.

After the alarm there are still several months of operating hours left in the battery.

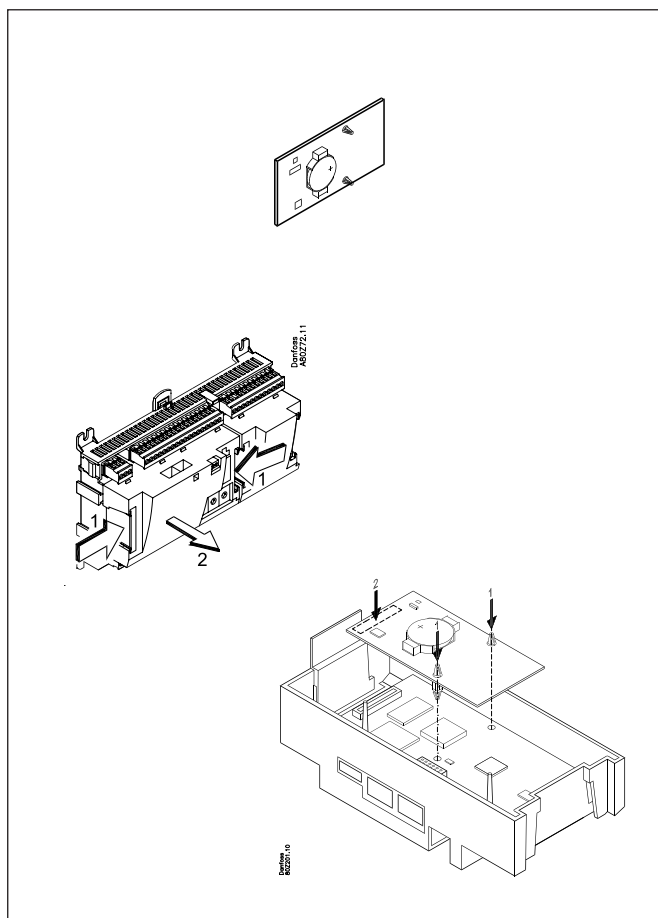

Transformer module AK-PS 075 / 150

Function

24 V supply for controller.

Supply voltage

230 V a.c. or 115 V a.c. (from 100 V a.c. to 240 V a.c.)

Placing

On DIN-rail

Effect

Type	Output tension	Output current	Power
AK-PS 075	24 V d.c.	0.75 A	18 VA
AK-PS 150	24 V d.c.	1.5 A	36 VA

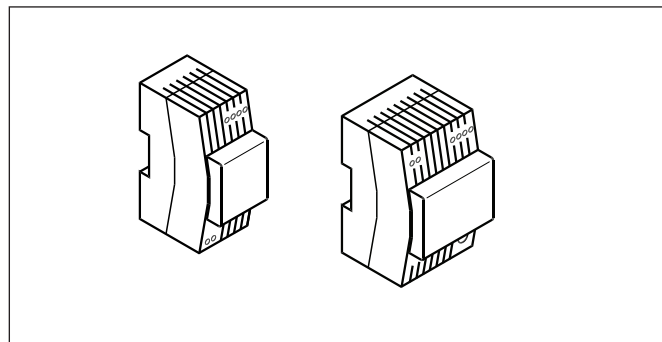

Dimension

Type	High	Width
AK-PS 075	90 mm	36 mm
AK-PS 150	90 mm	54 mm

Connections

Supply to a controller

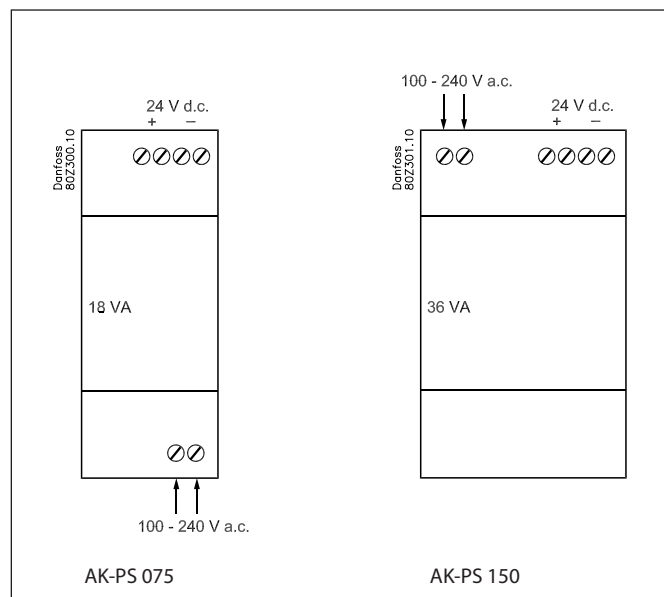
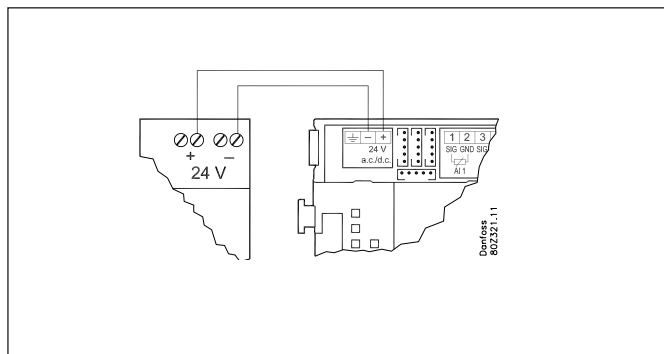

Communication module AK-CM 102

Function

The module is a new communication module, meaning the row of extension modules can be interrupted.

The module communicates with the regulator via data communication and forwards information between the controller and the connected extension modules.

Connection

Communication module and controller fitted with RJ 45 plug connectors.

Nothing else should be connected to this data communication; a maximum of 5 communication modules can be connected to one controller.

Communication cable

One metre of the following is enclosed:
ANSI/TIA 568 B/C CAT5 UTP cable w/ RJ45 connectors.

Positioning

Max. 30 m from the controller
(The total length of the communication cables is 30 m)

Supply voltage

24 volt AC or DC should be connected to the communication module.

The 24 V can be sourced from the same supply that supplies the controller. (The supply for the communication module is galvanically separated from the connected extension modules).

The terminals must **not** be earthed.

The power consumption is determined by the power consumption of the total number of modules.

The controller strand load must not exceed 32 VA.

Each AK-CM 102 strand load must not exceed 20 VA.

Point

Connection points on the I/O modules should be defined as if the modules were an extension of each other.

Address

The address for the first communication module should be set to 1. Any second module should be set to 2. A maximum of 5 modules can be addressed.

Termination

The termination switch on the final communication module should be set to ON.

The controller should permanently be set to = ON.

Warning

Additional modules may only be installed following the installation of the final module. (Here following module no. 11; see the sketch.)

After configuration, the address must not be changed.

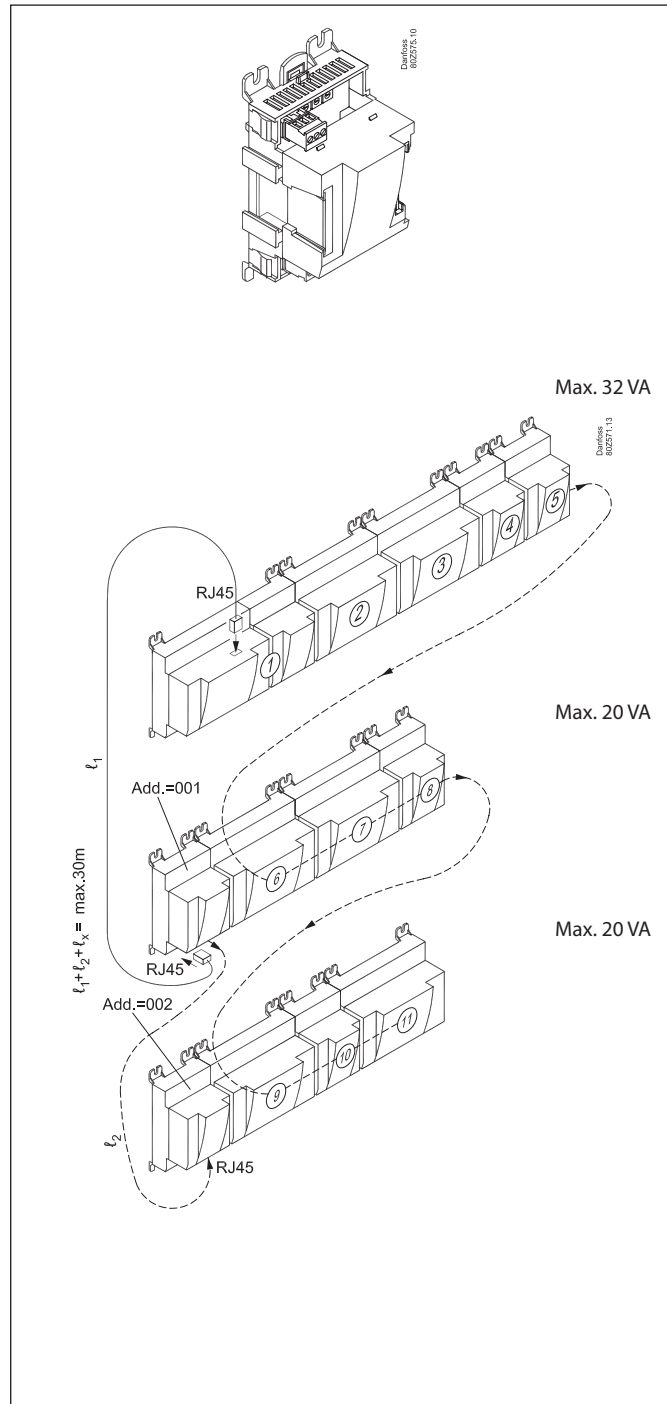

Preface to design

Be aware of the following when the number of extension modules is being planned. A signal may have to be changed, so that an additional module may be avoided.

- An ON/OFF signal can be received in two ways. Either as a contact signal on an analog input or as voltage on a low or high-voltage module.
- An ON/OFF output signal can be given in two ways. Either with a relay switch or with solid state. The primary difference is the permitted load and that the relay switch contains a cutout switch.

Mentioned below is a number of functions and connections that may have to be considered when a regulation has to be planned. There are more functions in the controller than the ones mentioned here, but those mentioned have been included in order that the need for connections can be established.

Functions

Clock function

Clock function and change-over between summer time and winter time are contained in the controller.

The clock is zeroset when there is power failure.

The clock's setting is maintained if the controller is linked up in a network with a gateway, a system manager or a clock module can be mounted in the controller.

Start/stop of regulation

Regulation can be started and stopped via the software.

Alarm function

If the alarm is to be sent to a signal transmitter, a relay output will have to be used.

Forced control

The software contains a forced control option. If an extension module with relay outputs is used, the module's top part can be with change-over switches – switches that can override the individual relays into either OFF or ON position.

Data communication

The controller module has terminals for LON data communication. The requirements to the installation are described in a separate document. Literature no. RC8AC.

Connections

In principle there are the following types of connections:

Analog inputs "AI"

This signal must be connected to two terminals.
Signals can be received from the following sources:

- Temperature signal from Pt 1000 ohm temperature sensor
- Contact signal where the input is short-circuited or "opened", respectively
- Voltage signal from 0 to 10 V
- Signal from pressure transmitter AKS 32, AKS 32R or AKS 2050.

The supply voltage is supplied from the module's terminal board where there is both a 5 V supply and a 12 V supply.
When programming the pressure transmitter's pressure range must be set.

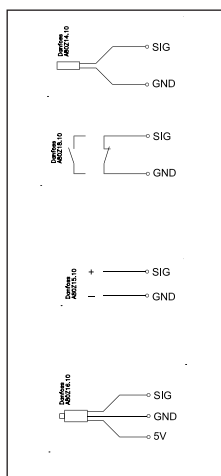

ON/OFF output signals "DO"

There are two types, as follows:

- Relay outputs
All relay outputs are with change-over relay so that the required function can be obtained when the controller is without voltage.
- Solid state outputs
Primarily for AKV valves that switch frequently, but the output can connect an external relay as well as a relay output.
The output is only found on the controller module.

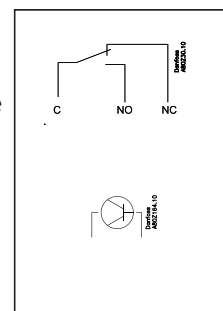

When programming the function must be set:

- Active when the output is activated
- Active when the output is not activated.

ON/OFF voltage inputs "DI"

This signal must be connected to two terminals.

- The signal must have two levels, either 0 V or "voltage" on the input.

There are two different extension modules for this signal type:

- low-voltage signals, e.g. 24 V
- high-voltage signals, e.g. 230 V

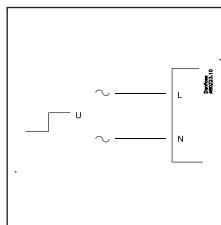

Pulse counter inputs "CI"

This signal must be used if consumption measurement is to take place.

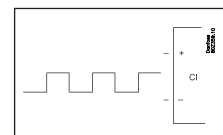

When programming the function must be set:

- Active when the input is without voltage
- Active when voltage is applied to the input.

Limitations

As the system is very flexible regarding the number of connected units you must check whether your selection complies with the few limitations there are.

The complexity of the controller is determined by the software, the size of the processor, and the size of the memory. It provides the controller with a certain number of connections from which data can be downloaded, and others where coupling with relays can be performed.

- ✓ The sum of connections cannot exceed 120.
- ✓ The number of extension modules must be limited so that the total power will not exceed 32 VA (including controller).
- ✓ No more than five pressure transmitters may be connected to one controller module.
- ✓ No more than five pressure transmitters may be connected to one extension module.

Design of a monitoring

Procedure:

1. Make a sketch of the system in question
2. Check that the controller's functions cover the required application
3. Consider the connections to be made
4. Use the planning table. / Note down the number of connections
./ add up
5. Are there enough connections on the controller module? – If not, can they be obtained by changing an ON/OFF input signal from voltage signal to contact signal, or will an extension module be required?
6. Decide which extension modules are to be used
7. Check that the limitations are observed
8. Calculate the total length of modules
9. The modules are linked together
10. The connection sites are established
11. Draw a connection diagram or a key diagram
12. Size of supply voltage/transformer

← Follow these 12 steps

1

Sketch

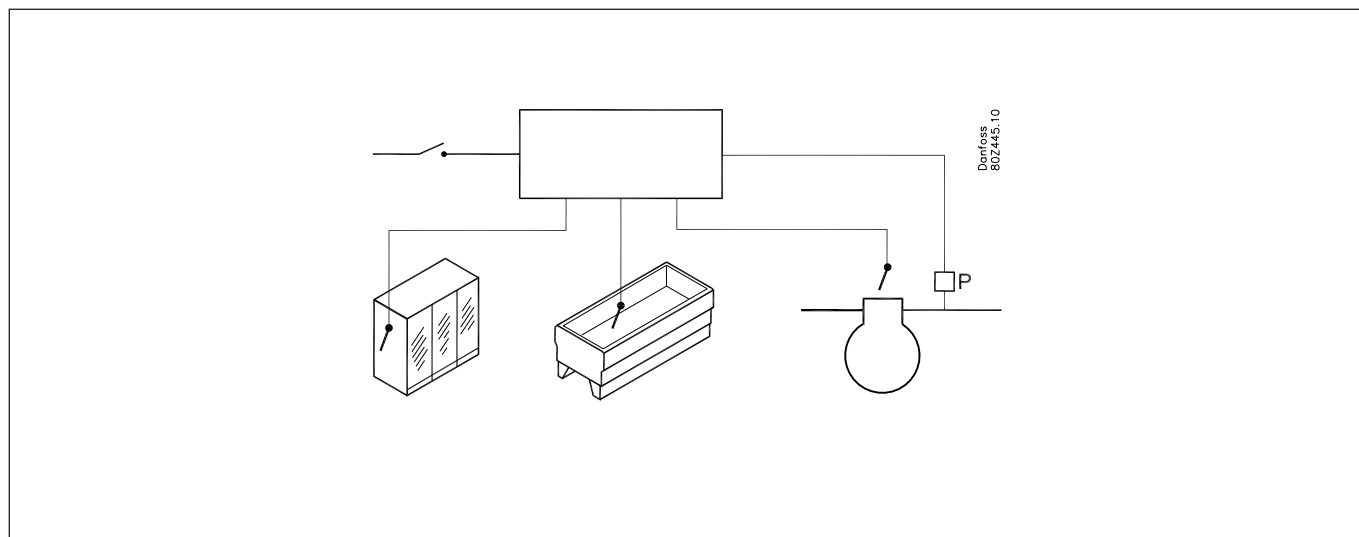

Make a sketch of the system in question.

2

Monitoring unit

	AK-LM 350
Application	
Monitoring of temperatures, pressure, voltages and On/off signals	x
COP calculation	x
General relay functions for thermostats, pressostats, voltages and On/Off signals	x
Consumption measurement via pulse inputs	x
Alarm relays	x
Thermostat function	
Number	5
Cutin and Cutout values for relay	x
Alarm limits and delay times	x
Extended delay time during defrost	x
Alarms suspend during case cleaning	x
Pressostat functions	
Number	5
Cutin and Cutout values for relay	x
Alarm limits and delay times	x
Voltage signal	
Number	5
Scaling of read out signal. for ex. 0-10 V = 0-100% humidity	x
Cutin and Cutout values for relay	x
Alarm limits and delay times	x
Delay times on cutin and cutout of relays	x
On/Off signals	
Number	16
Closed contact / 24 V signal / 230 V signal	x
Alarm and relay function with delay	x
Counter function for switch to "On"	x
Time Counter for "On"	x
Consumption measurement	
Number	8
Pulse signal acc. DIN 43864	x
Synchronising signal (connected to a separate pulse input)	1
Read out of the consumption of the last 24 hours	x
Read out of the consumption during the last week	x
Read out of the total consumption since the last reset	x
Alarm relay	
Number	2
Priority "high" or priority "low to high"	x
Miscellaneous	
Alarm priorities	x
Sensor correction	x

If you want to know more about the functions, go to chapter 5.
COP signals in chapter 6.

3 Connections

Here is a survey of the possible connections. The texts can be read in context with the table in point 4.

Analog inputs

Temperature sensors

Temperature sensors that can be used by thermostats for monitoring, relay control and alarm functions (S1 - S40).

Voltage signal

Voltage signals that can be used for monitoring, relay control and alarm functions (Volt input 1-20).

Pressure transmitters

Pressure transmitter signals that can be used by pressostats for monitoring, relay control and alarm functions (P1 - P20).

Pulse inputs

- Energy reading
- Synchronisation

On/Off-inputs

Contact function (on an analog input)

or

Voltage signal (on an extension module)

On/off signals that are used for monitoring, relay control and alarm functions (DI1-DI20).

- Defrosting signals that are used to extend alarm delays for thermostats.
- Appliance cleaning signal to stop alarms from the thermostat.
- Signal to reset the alarm relay (mute function).

On/off outputs

Relay outputs

- Thermostat functions 1-5
- Voltage signals 1-5
- Pressostat functions 1-5
- Digital input functions 1-16
- Alarm relays 1-2

Example

COP calculation on a CO2 booster system with heat recovery.

- Pressure readings can be retrieved from the other AK controllers when the signal originates from AKS 32R and AKS 2050 ratiometric transmitters.
- Temperature readings **cannot** be shared.

- Current connected capacity can be retrieved using a 0-10V signal from the other AK controllers.
- Register the position of three-way valves (on/off signal).

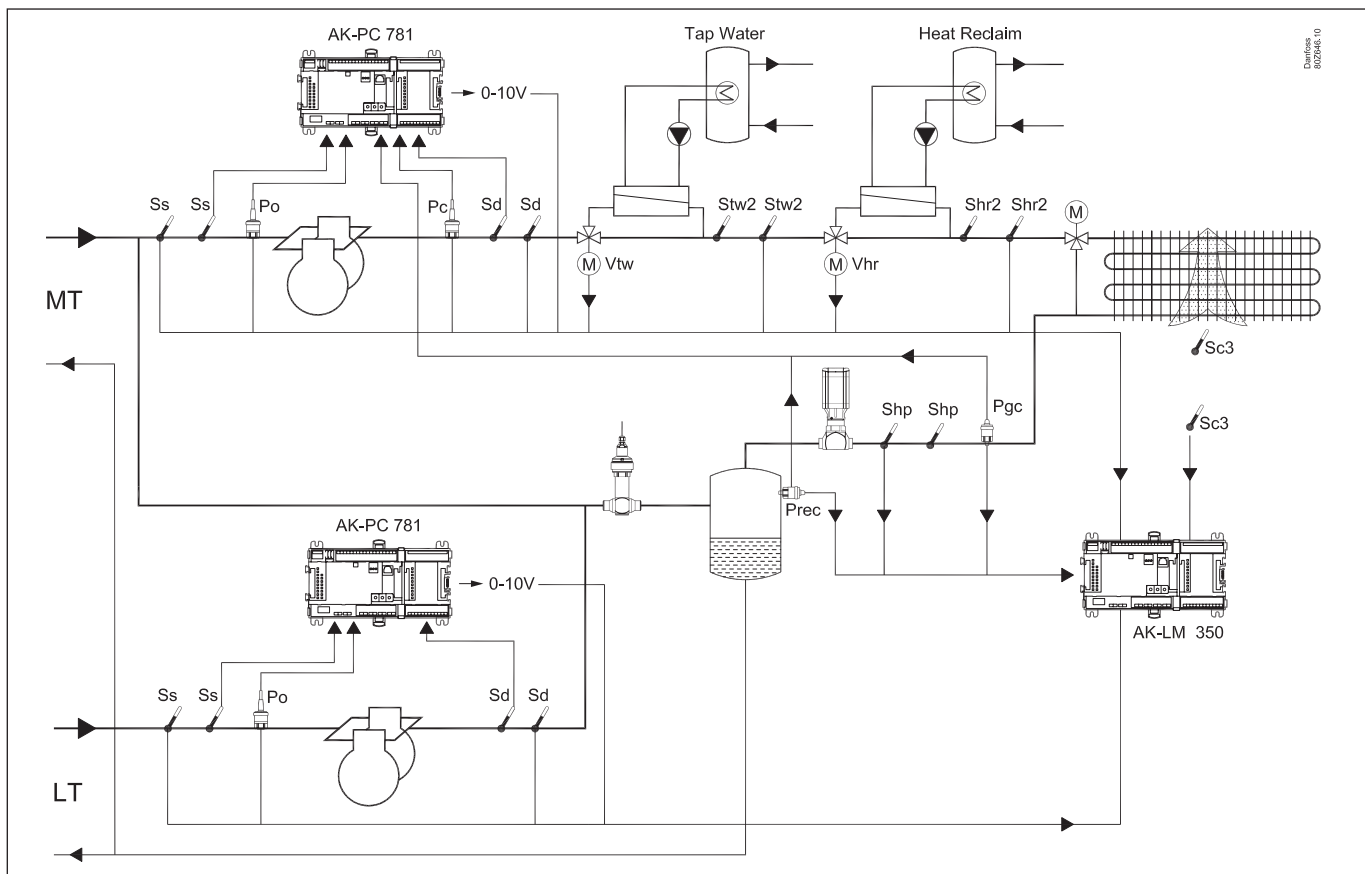

Data from this example is used on the next page.

The result is that the following modules should be used:

- AK-LM 350 Monitoring unit
- AK-XM 101A extension module with analogue inputs

4 Planning table	Analog input signal Example	On/off voltage signal Example	On/off voltage signal Example	Pulse signal Example	On/Off output signal Example	7 Limitations
<p>The table helps you establish whether there are enough inputs and outputs on the basic controller. If there are not enough of them, the controller must be extended by one or more of the mentioned extension modules.</p> <p>Note down the connections you will require and add them up</p>						
Analog inputs						<p>P = Max. 5</p> <p style="text-align: right; font-size: small;">The example: None of the 3 limitations are exceeded => OK</p>
Temperature sensors S1 - S40	8					
Voltage signals Volt-input 1-20	2					
Pressure transmitter P1 - P20	5					
On/off inputs (DI1 - DI20)	Contact	24 V	230 V			
Monitoring						
Extended defrost delays						
Case cleaning signal						
Signal to reset alarm relay						
Valve position	2					
Pulse inputs						
Energy measurement (1-8)						
Synchronizing signal						
On/off outputs						
Relays for thermostat functions (1-5)						
Relays for voltage signals (1-5)						
Relays for pressostat functions (1-5)						
Relays for digital input functions (1-16)						
Relays for alarm function (1-2)						
5 Sum of connections for the regulation	17	0	4	1	0	Sum = max. 120
Number of connections on a controller module	11	11	0	0	8	8
Missing connections, if applicable	6	0	4	1	0	
6 The missing connections to be supplied by one or more extension modules:						Sum of power
AK-XM 101A (8 analog inputs)	+1					__ pcs. á 2 VA = __
AK-XM 102A (8 digital low voltage inputs)						__ pcs. á 2 VA = __
AK-XM 102B (8 digital high voltage inputs)						__ pcs. á 2 VA = __
AK-XM 107A (8 pulse inputs)						__ pcs. á 2 VA = __
AK-XM 204A / B (8 relay outputs)						__ pcs. á 5 VA = __
AK-XM 205A / B (8 analog inputs + 8 relay outp.)						__ pcs. á 5 VA = __
						1 pcs. á 8 VA = 8
						Sum =
						Sum = max. 32 VA

8 Length

If you use many extension modules the controller's length will grow accordingly. The row of modules is a complete unit which cannot be broken.

The module dimension is 72 mm.

Modules in the 100-series consist of one module

Modules in the 200-series consist of two modules

The controller consist of three modules

The length of an aggregate unit = $n \times 72 + 8$

or in an other way:

Module	Type	Number	at	Length
Controller module		1	x	224
Extension module	200-series	—	x	144
Extension module	100-series	—	x	72
Total length				= ___ mm

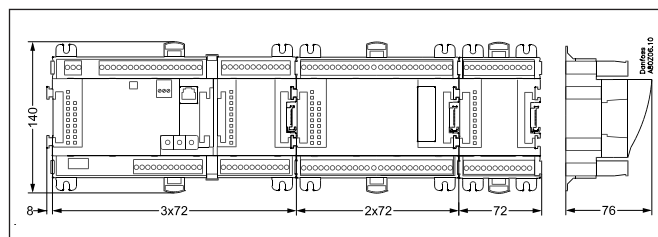

Example continued:
Controller module + 1 extension modules in 100-series =
 $224 + 72 = 296$ mm.

9 Linking of modules

Start with the controller module and then mount the selected extension modules. The sequence is of no importance.

However, you must **not** change the sequence, i.e. rearrange the modules, after you have made the setup where the controller is told which connections are found on which modules and on which terminals.

The modules are attached to one another and kept together by a connection which at the same time transmits the supply voltage and the internal data communication to the next module.

Mounting and removal must always be performed when there is no voltage.

The protective cap mounted on the controller's plug connection must be moved to the last vacant plug connection so that the plug will be protected against short-circuit and dirt.

When the regulation has started the controller will all the time check whether there is connection to the connected modules. This status can be followed by the light-emitting diode.

When the two catches for the DIN rail mounting are in open position the module can be pushed into place on the DIN rail – no matter where in the row the module is found. Removal is likewise carried out with the two catches in the open position.

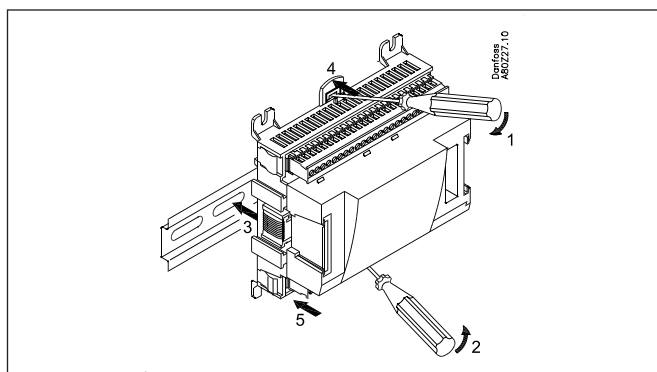
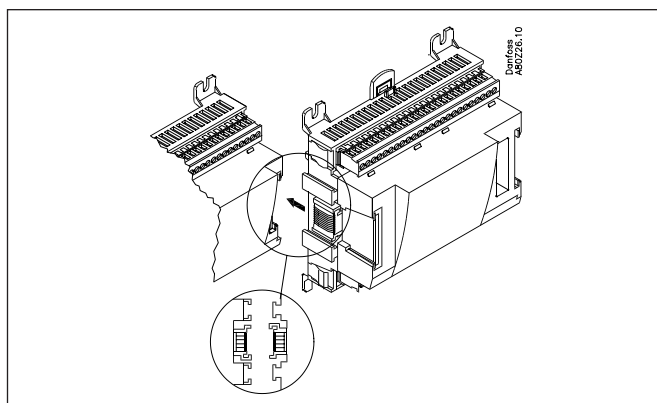
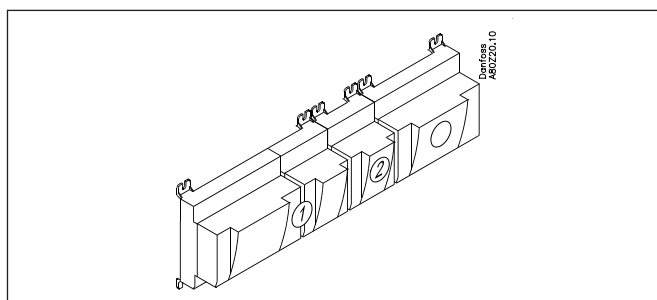

10 Determine the connection points

All connections must be programmed with module and point, so in principle it does not matter where the connections are made, as long as it takes place on a correct type of input or output.

- The controller is the first module, the next one is 2, etc.
- A point is the two or three terminals belonging to an input or output (e.g. two terminals for a sensor and three terminals for a relay).

The preparation of the connection diagram and the subsequent programming (configuration) should take place at the present time. It is most easily accomplished by filling in the connection survey for the relevant modules.

Principle:

Name	On module	On Point	Function
fx Compressor 1	x	x	ON
fx Compressor 2	x	x	ON
fx Alarm relay	x	x	OFF
fx Main switch	x	x	Close
fx PO	x	x	AKS 32R 1-6 bar

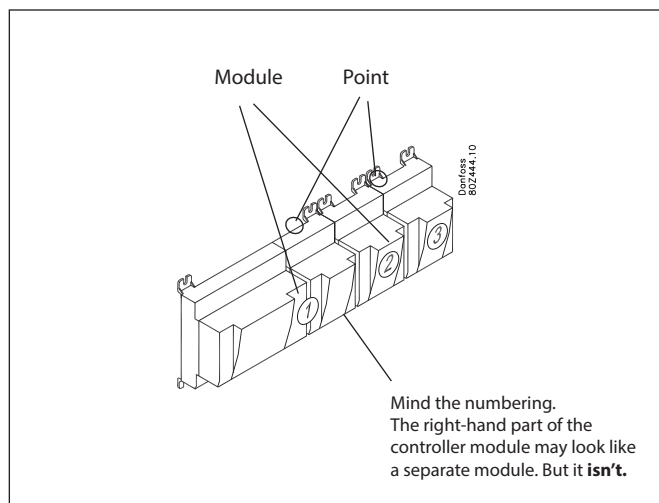

The connection survey from the controller and any extension modules are uploaded from the paragraph "Module survey. E.g. controller module:

Signal	Module	Point	Terminal	Signal type / Active at
		1 (AI 1)	1 - 2	
		2 (AI 2)	3 - 4	
		3 (AI 3)	5 - 6	
		4 (AI 4)	7 - 8	

- Columns 1, 2, 3 and 5 are used for the programming.
- Columns 2 and 4 are used for the connection diagram.

Tip
The Appendix shows 16 general installation types. If your plant closely resembles one of those shown, you can use the connection points indicated for it.

Signal	Module	Point	Terminal	Signal type / Active at
Ss MT	1	1 (AI 1)	1 - 2	Pt 1000
Sd MT		2 (AI 2)	3 - 4	Pt 1000
Cutin comp. capacity MT		3 (AI 3)	5 - 6	0-10 V
Stw2		4 (AI 4)	7 - 8	Pt 1000
Shr2		5 (AI 5)	9 - 10	Pt 1000
Pgc MT		6 (AI 6)	11 - 12	AKS 2050-159
Prec MT		7 (AI 7)	13 - 14	AKS 2050-159
Vtw		8 (AI 8)	19 - 20	Open
Vhr		9 (AI 9)	21 - 22	Open
Po MT		10 (AI 10)	23 - 24	AKS 2050-59
Pc MT		11 (AI 11)	25 - 26	AKS 2050-159
		12 (DO 1)	31 - 32	
		13 (DO 2)	33 - 34	
		14 (DO 3)	35 - 36	
		15 (DO 4)	37 - 38	
		16 (DO 5)	39-40-41	ON
		17 (DO6)	42-43-44	ON
		18 (DO7)	45-46-47	ON
		19 (DO8)	48-49-50	OFF
	24	-		
	25	-		

Signal	Module	Point	Terminal	Signal type / Active at
Sc3	2	1 (AI 1)	1 - 2	Pt 1000
Shp		2 (AI 2)	3 - 4	Pt 1000
		3 (AI 3)	5 - 6	
Po LT		4 (AI 4)	7 - 8	AKS 2050-59
Ss LT		5 (AI 5)	9 - 10	Pt 1000
Sd LT		6 (AI 6)	11 - 12	Pt 1000
Cutin comp. capacity LT		7 (AI 7)	13 - 14	0-10 V
		8 (AI 8)	15 - 16	

11

Connection diagram

Drawings of the individual modules may be ordered from Danfoss.
Format = dwg and dxf.

You may then yourself write the module number in the circle and draw the individual connections.

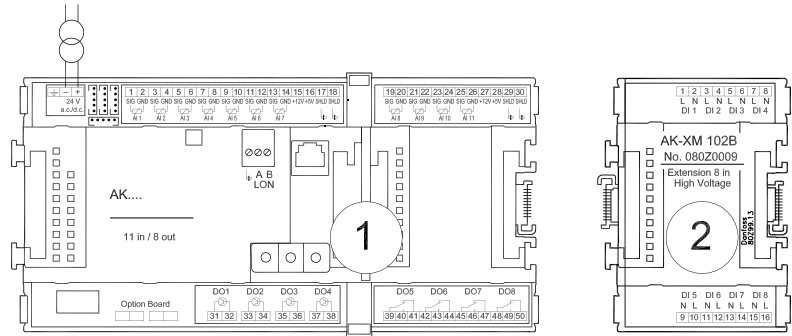

Example continued:

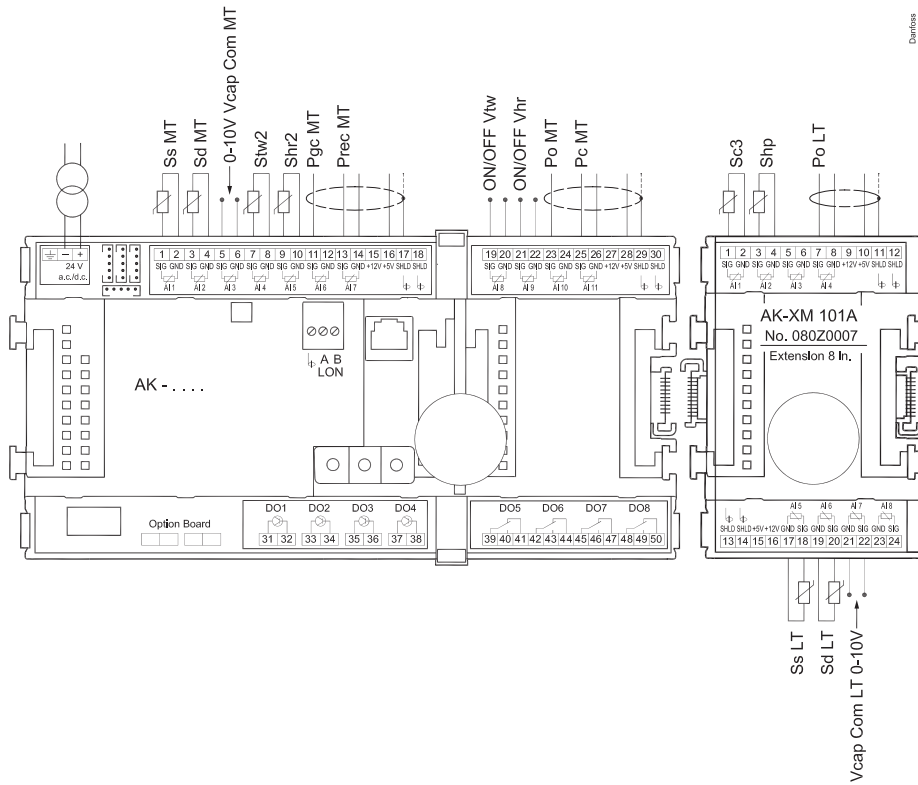

Danfoss
802647.10

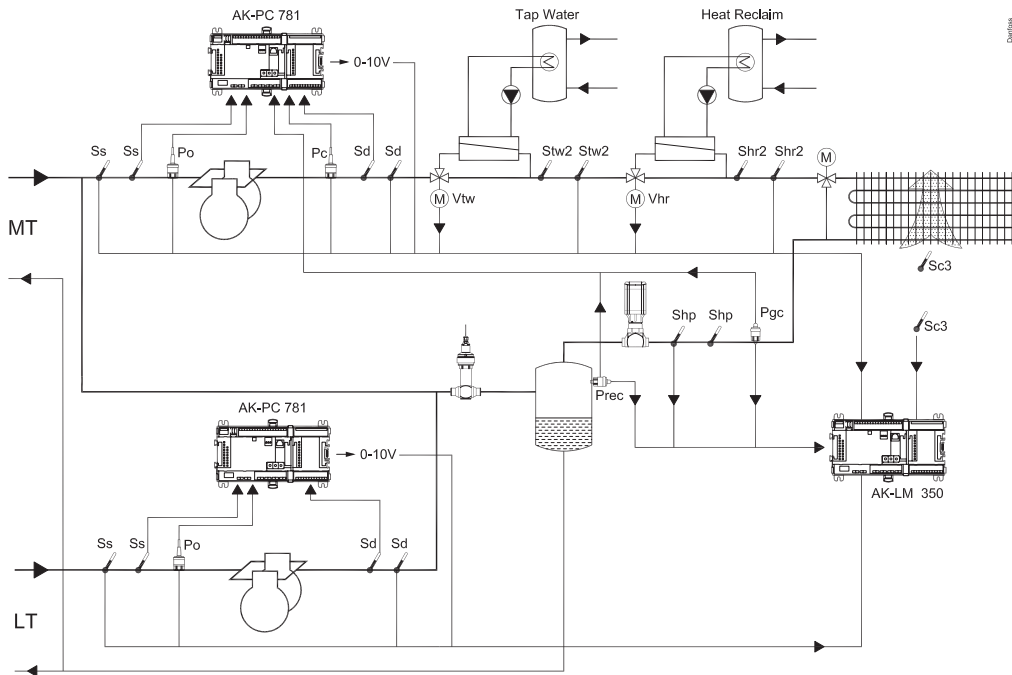

Danfoss
802648.10

12 Supply voltage

Supply voltage is only connected to the controller module. The supply to the other modules is transmitted via the plug between the modules. The supply must be 24 V +/-20%. One transformer must be used for each controller. The transformer must be a class II. The 24 V must **not** be shared by other controllers or units. The analog inputs and outputs are **not** galvanically separated from the supply.

Transformer size

The power consumption grows with the number of modules used:

Module	Type	Number	á	Effect
Controller		1	x 8 =	8 VA
Extension module	200-series	_	x 5 =	__ VA
Extension module	100-series	_	x 2 =	__ VA
Total				___ VA

The + and - 24V input **must not** be earthed.

Example continued:

Controller module	8 VA
+ 1 extension module in 100-series	2 VA

Transformer size (least)	10 VA

Ordering

1. Controller

Type	Function	Application	Language	Code no.	Example continued
AK-LM 350	Monitoring unit with COP calculation	Monitoring of temperatures, pressure, voltages etc.	English, German, French, Dutch, Italian, Spanish, Portuguese, Danish, Finnish, Russian, Polish, Czech, Chinese	080Z0176	x

2. Extension modules and survey for inputs and outputs

Type	Analog inputs	On/Off outputs		On/off supply voltage (DI signal)			Module with switches	Code no.	Example continued
	For sensors, pressure transmitters etc.	Relay (SPDT)	Solid state	Low voltage (max. 80 V)	High voltage (max. 260 V)	Pulse counter			
Controller	11	4	4	-	-	-	-	-	
Extension modules									
AK-XM 101A	8							080Z0007	x
AK-XM 102A				8				080Z0008	
AK-XM 102B					8			080Z0013	
AK-XM 204A		8						080Z0011	
AK-XM 204B		8					x	080Z0018	
AK-XM 205A	8	8						080Z0010	
AK-XM 205B	8	8					x	080Z0017	
AK-XM 107A						8		080Z0020	

3. AK operation and accessories

Type	Function	Application	Code no.	Example continued
Operation				
AK-ST 500	Software for operation of AK controllers	AK-operation	080Z0161	x
-	Cable between PC and AK controller	AK - Com port	080Z0262	x
-	Cable between zero modem cable and AK controller / Cable between PDA cable and AK controller	AK - RS 232	080Z0261	
-	Cable between PC and AK controller	AK - USB	080Z0264	
Accessories Transformer module 230 V / 115 V to 24 V				
AK-PS 075	18 VA	Supply for controller	080Z0053	x
AK-PS 150	36 VA		080Z0054	
Accessories Real time clock for use in controllers that require a clock function, but are not wired with data communication.				
AK-OB 101A	Real time clock with battery backup.	To be mounted in an AK controller	080Z0252	
Accessories Communication modules for controllers where modules cannot be connected continuously				
AK-CM 102	Communication module	Data communication for external extension modules	080Z0064	

3. Mounting and wiring

This section describes how the controller:

- Is fitted
- Is connected

We have decided to work on the basis of the example we went through previously, i.e. the following modules:

- AK-LM 350 Monitoring unit
- AK-XM 101A analog input module

Mounting

Mounting of extension module on the basic module

1. Move the protective cap

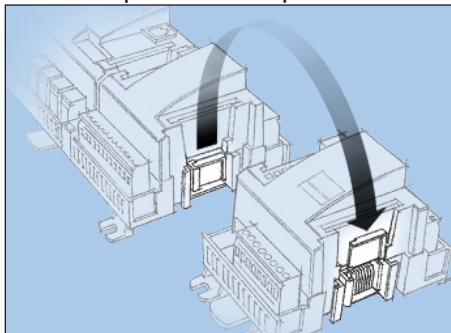

Remove the protective cap from the connection plug on the right-hand side of the basic module.
Place the cap on the connection plug to the right of the extension module that is to be mounted on the extreme right-hand side of the AK assembly.

2. Assemble the extension module and the basic module

The basic module must not be connected to voltage.

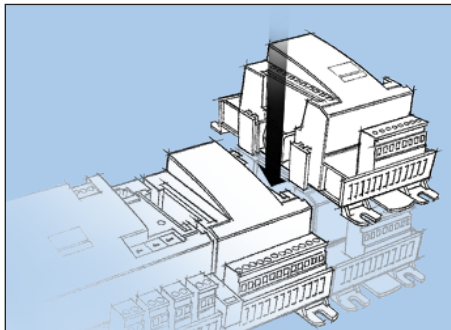

In our example two extension modules are to be fitted to the basic module. The sequence is thus:

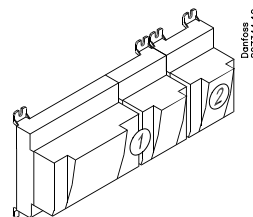

All the subsequent settings that affect the two modules are determined by this sequence.

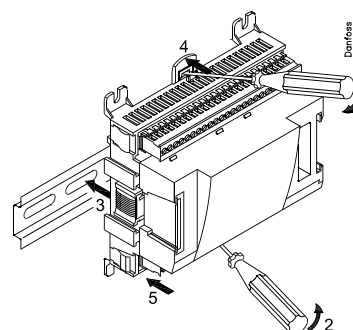
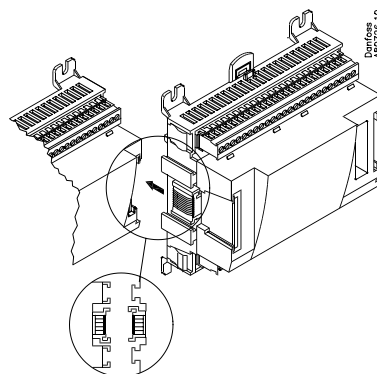

When the two snap catches for the DIN rail mounting are in the open position, the module can be pushed into place on the DIN rail – regardless of where the module is on the row.

Disassembly is thus done with the two snap catches in the open position.

Wiring

Decide during planning which function is to be connected and where this will be.

1. Connect inputs and outputs

Here are the tables for the example:

Signal	Module	Point	Terminal	Signal type / Active at
Ss MT	1	1 (AI 1)	1 - 2	Pt 1000
Sd MT		2 (AI 2)	3 - 4	Pt 1000
Cutin comp. capacity MT		3 (AI 3)	5 - 6	0-10 V
Stw2		4 (AI 4)	7 - 8	Pt 1000
Shr2		5 (AI 5)	9 - 10	Pt 1000
Pgc MT		6 (AI 6)	11 - 12	AKS 2050-159
Prec MT		7 (AI 7)	13 - 14	AKS 2050-159
Vtw		8 (AI 8)	19 - 20	Open
Vhr		9 (AI 9)	21 - 22	Open
Po MT		10 (AI 10)	23 - 24	AKS 2050-59
Pc MT		11 (AI 11)	25 - 26	AKS 2050-159
		12 (DO 1)	31 - 32	
		13 (DO 2)	33 - 34	
		14 (DO 3)	35 - 36	
		15 (DO 4)	37 - 38	
		16 (DO 5)	39-40-41	
		17 (DO6)	42-43-44	
		18 (DO7)	45-46-47	
		19 (DO8)	48-49-50	
		24	-	
		25	-	

Signal	Module	Point	Terminal	Signal type / Active at
Sc3	2	1 (AI 1)	1 - 2	Pt 1000
Shp		2 (AI 2)	3 - 4	Pt 1000
		3 (AI 3)	5 - 6	
Po LT		4 (AI 4)	7 - 8	AKS 2050-59
Ss LT		5 (AI 5)	9 - 10	Pt 1000
Sd LT		6 (AI 6)	11 - 12	Pt 1000
Cutin comp. capacity LT		7 (AI 7)	13 - 14	0-10 V
		8 (AI 8)	15 - 16	

IMPORTANT!

It is important that the sensors are located so that they measure the correct temperature.

Both location and full, direct contact with the pipes and similar are required for obtaining a proper measurement.

The function of the switch functions can be seen in the last column.

If the temperature sensors are installed via long cables, the signals can be led through a shared cable. If a shared GND is used for temperature sensors, this GND and the temperature sensors must be connected to the **same** module.

The connections for the example can be seen here.

Warning
Keep signal cables separate from cables with high voltage.

The screen on the pressure transmitter cables must only be connected at the end of the controller. (both controllers)

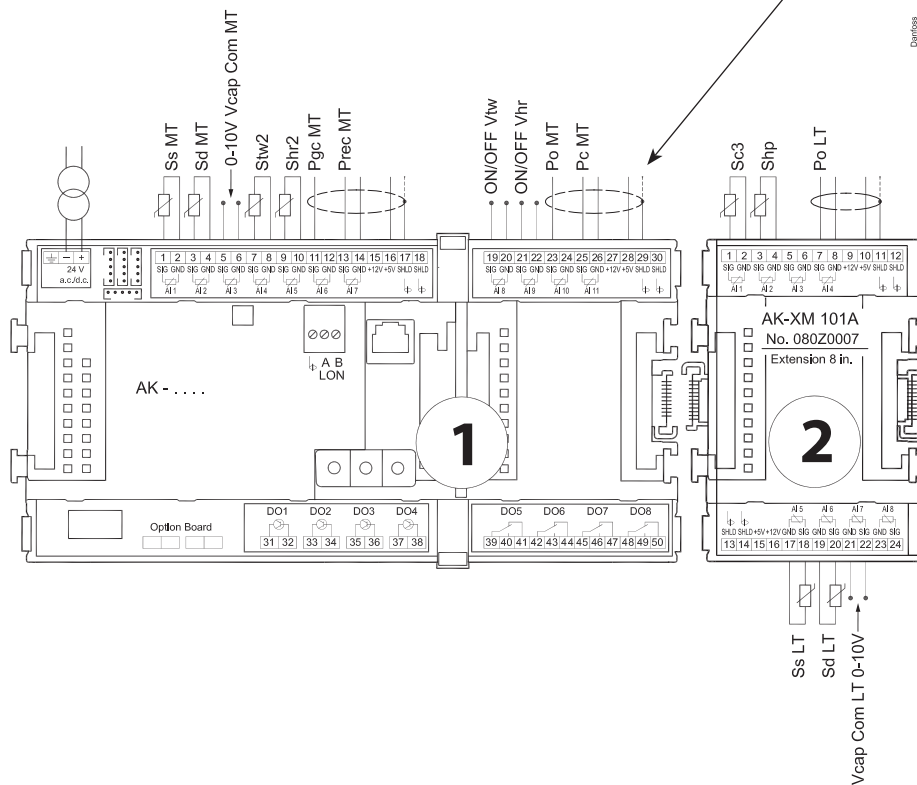

2. Connect LON communication network

The installation of the data communication must comply with the requirements set out in document RC8AC.

3. Connect supply voltage

Is 24 V, and the supply must not be used by other controllers or devices. The terminals **must not** be earthed.

4. Follow light-emitting diodes

When the supply voltage is connected the controller will go through an internal check. The controller will be ready in just under one minute when the light-emitting diode "Status" starts flashing slowly.

5. When there is a network

Set the address and activate the Service Pin. When the controller is set correct on the network the LED "status" will flash quickly for 10 minutes.

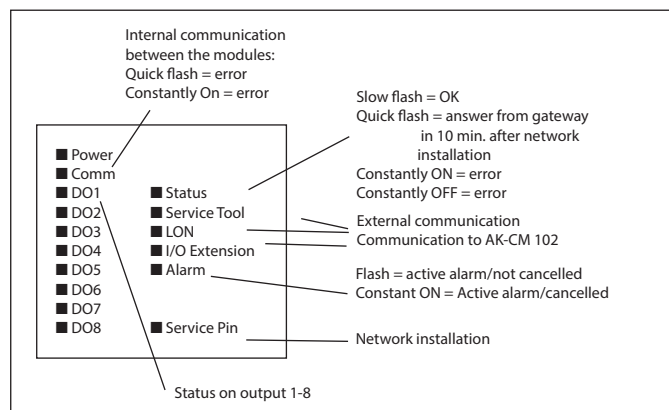

6. The controller is now ready to be configured.

4. Configuration and operation

This section describes how the controller:

- Is configured
- Is operated

We have decided to work on the basis of the example we went through previously, i.e. COP calculation on a CO₂ booster plant. The example is shown overleaf.

Refrigerating plant example

We have decided to describe the setup by means of an example comprising the connections shown below.

The example is the same as the one given in the "Design" section, i.e. the controller is an AK-LM 350 + 1 extension module.

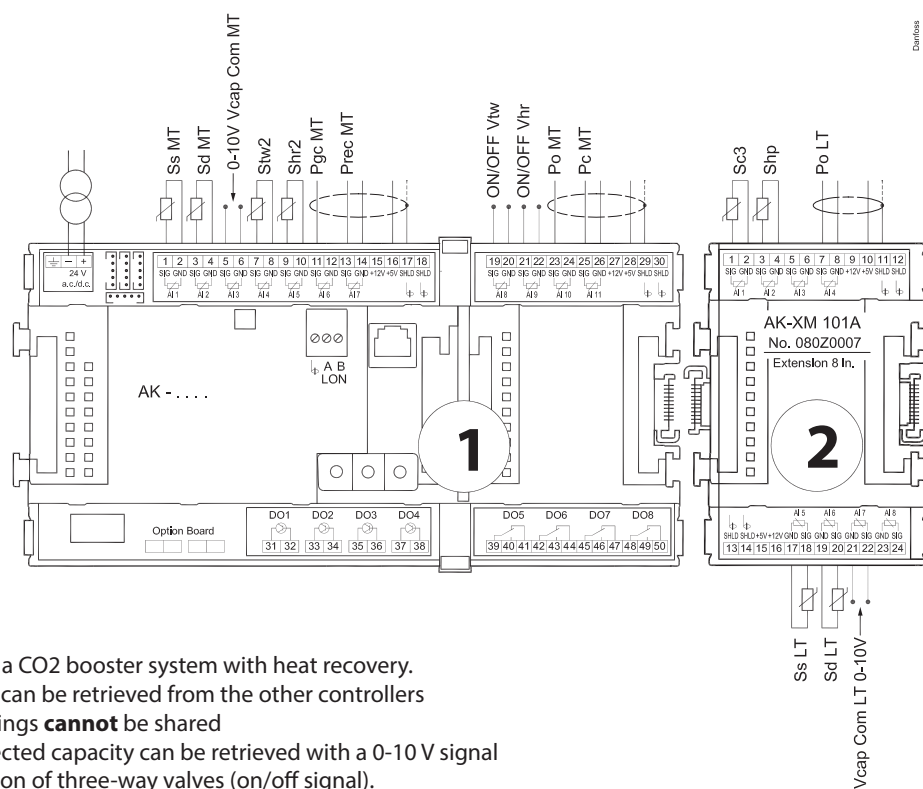
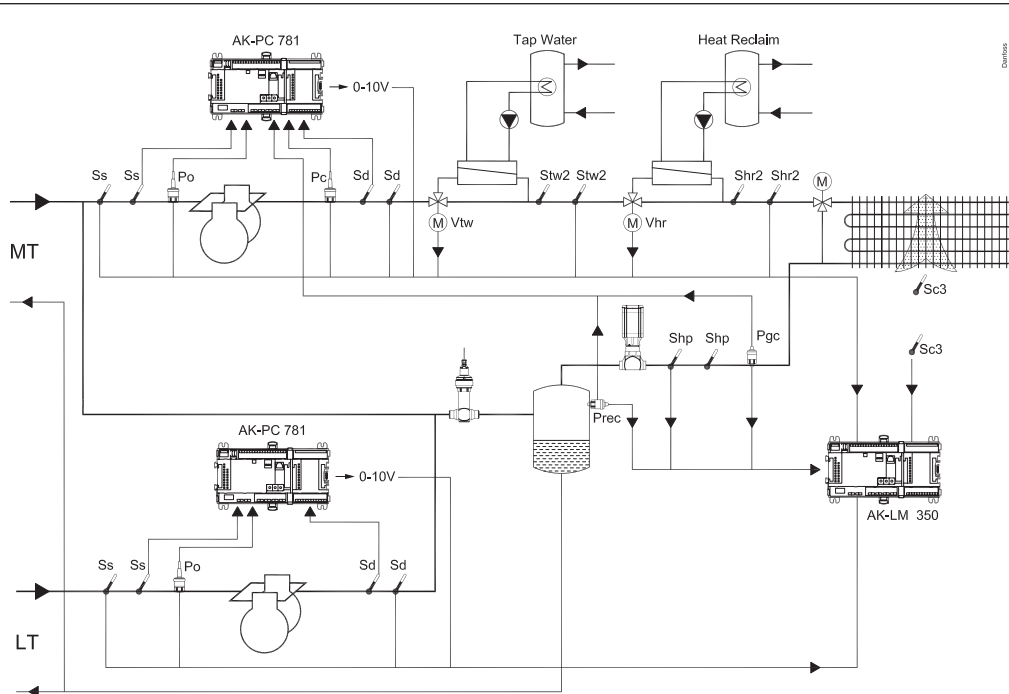

Example:

COP calculation on a CO₂ booster system with heat recovery.

- Pressure readings can be retrieved from the other controllers
- Temperature readings **cannot** be shared
- The current connected capacity can be retrieved with a 0-10 V signal
- Register the position of three-way valves (on/off signal).

Configuration

Connect PC

PC with the program "Service Tool" is connected to the controller.

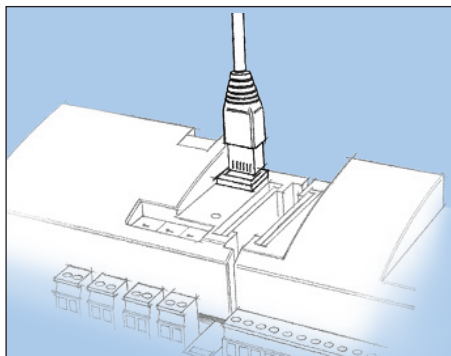

The controller must be switched on first and the LED "Status" must flash before the Service Tool programme is started.

Start Service Tool programme

Login with user name SUPV

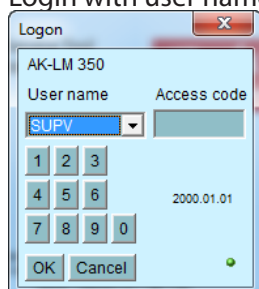

Select the name **SUPV** and key in the access code.

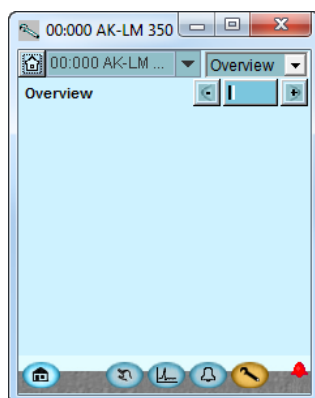

For connecting and operating the "AK service tool" software, please see the manual for the software.

The first time the Service Tool is connected to a new version of a controller the start-up of the Service Tool will take longer than usual while information is retrieved from the controller. Time can be followed on the bar at the bottom of the display.



When the controller is supplied the SUPV access code is 123. When you are logged into the controller an overview of it will always appear.

In this case the overview is empty. This is because the controller has not yet been set up. The red alarm bell at the bottom right tells you that there is an active alarm in the controller. In our case the alarm is due to the fact that the time in the controller has not yet been set.

Authorization

1. Go to Configuration menu

Press the orange setup button with the spanner at the bottom of the display.



2. Select Authorization

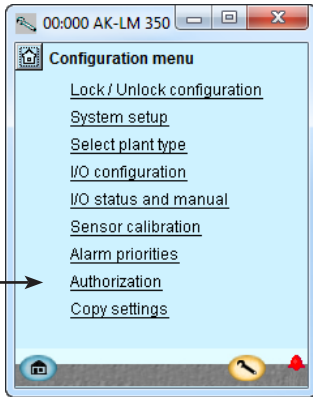

When the controller is supplied it has been set to show the default authorization for the different user interfaces. This setting should be changed and adapted to the plant. The changes can be made now or later.

You will use this button again and again whenever you want to get to this display. On the left-hand side are all the functions not shown yet. There will be more here the further into the setup we go.

Press the line **Authorization** to get to the user setup display.

3. Change setting for the user 'SUPV'

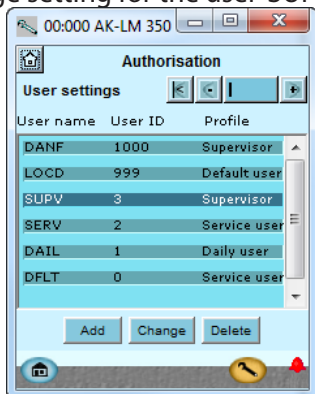

Mark the line with the user name **SUPV**. Press the button **Change**

4. Select username and access code

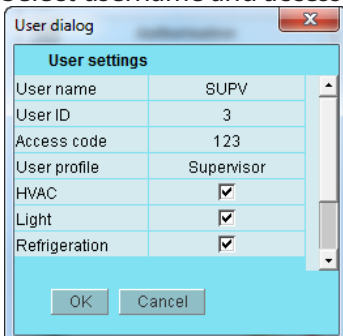

This is where you can select the supervisor for the specific system and a corresponding access code for this person.

The controller will utilize the same language that is selected in the service tool but only if the controller contains this language. If the language is not contained in the controller, the settings and readings will be shown in English.

5. Carry out a new login with the new user name and the new access code

To activate the display of the texts in the required language you must carry out a new login to the controller with the user name SUPV and the relevant access code.

You will access the login display by pressing the icon at the top left corner of the display.



Unlock the configuration of the controllers

1. Go to Configuration menu



2. Select Lock/Unlock configuration

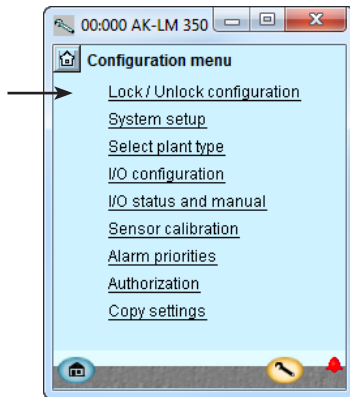

3. Select Configuration lock

Press the blue field with the text **Locked**

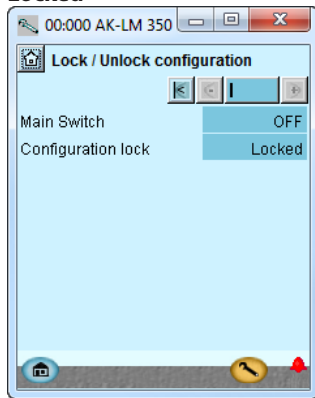

4. Select Unlocked

Select **Unlocked**



If you want to know more about the different configuration options, they are listed below. The number refers to the number and picture in the column on the left.

The controller can only be configured when it is unlocked.
It can only be adjusted when it is locked.

Changes to the input and output settings are only enabled when the controller is "Locked"

The values can be changed when it is locked, but only for those settings that do not affect the configuration.

In general

Many settings are dependent on previous settings. This is shown by the fact that a function can only be seen (and thus set) if an earlier parent function allows access to this subordinate function

For example, the "Configuration lock" line will not be shown if the main switch is set to On. Only when the main switch is set to Off, and regulation has therefore been stopped, is it possible to set the configuration lock.

3-

Main Switch

Used to start and stop regulation.

When the main switch is set to Off, all outputs are in standby mode and all alarms are cancelled.

The main switch must be set to Off before the Configuration lock can be Unlocked.

Configuration lock

The controller can only be fully configured when the configuration lock is set to Unlocked.

The settings are only applied when it is set to Locked again. At this point, the controller checks the functions set and compares them with the input and output settings. Important settings can then no longer be changed unless the configuration is unlocked again.

System setup

1. Go to Configuration menu



2. Select System setup

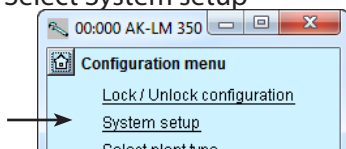

3. Set system settings

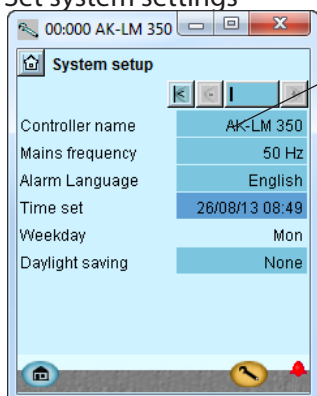

General

All system settings can be changed by pressing in the blue field with the setting and then indicating the value of the required setting.

3-

Controller name

In the first field you enter a name for what the controller will be controlling.

Main frequency

Set frequency.

Alarm language

Select the language that alarm text should be displayed in here.

Alarm text can be in a different language to the operating language.

Clock

When the time is set the PC's time can be transferred to the controller.

When the controller is connected to a network, date and time will automatically be set by the system unit in the network. This also applies to change-over Daylight saving.

Set plant type

1. Go to Configuration menu

2. Select plant type

Press the line **Select plant type**.

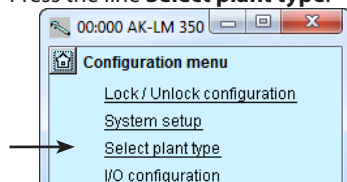

3. Set plant type

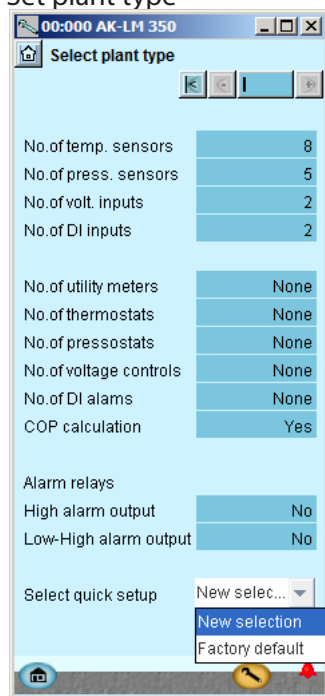

In the example, we have decided to use the following number of input signals for the COP calculation:

- 8 temperature sensors
- 5 pressure transmitters
- 2 voltage inputs
- 2 digital inputs

Set COP calculation to YES

3-

Select plant type

Select how many measurements of each type that will be used by the controller here.

One measurement can be used by several functions, so that, later, when setting the individual function, you select the measurement that will be used.

Number of temperature sensors:

Number of pressure readings:

Number of voltage inputs:

Number of digital inputs (DIs):

Number of energy readings:

Number of thermostats

Number of pressostats

Number of voltage signals

Number of digital inputs

COP calculation. (The controller will subsequently display what readings are required.)

Alarm relays

Define whether a relay which is enabled for alarms with high priority is to be used.

Define whether a relay which is enabled for alarms with all priorities is to be used.

If an alarm relay is defined, it will activate an alarm that must be reset externally.

Select quick setup

You can reset all settings and return to factory settings here.

TIP

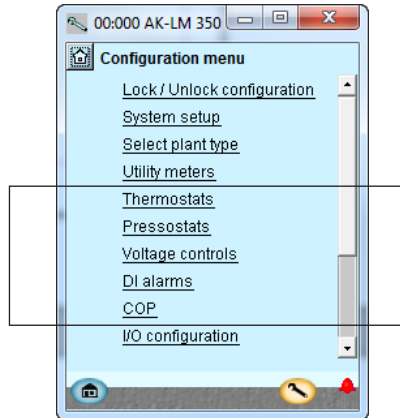

These functions use input signals. The name is factory-defined as e.g. "S1" or "DI1". You can change this name to something more easily comprehensible in the "I/O configuration" menu.

It may be advantageous to name the input signals before selecting them in the functions listed here.

Utility meters

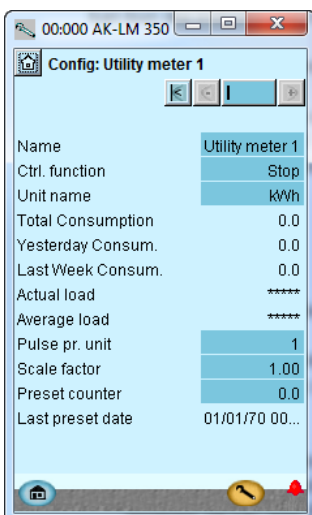
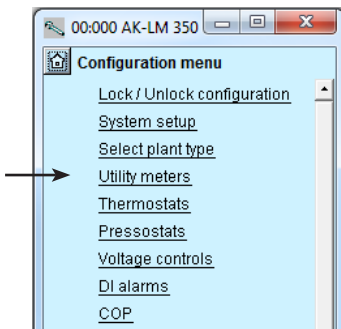

We have not used this function in our example. The image is included for guidance only.

Utility meters

- Name
- Start / stop of measuring
- Unit name.
kWh when measuring current, m3 when measuring gas.
- Readouts
Total consumption
Yesterday consump.
Last week consump.
- Pulse per unit: The number of pulses to be received for each unit of measurement.
- Scale factor: Any scale factor
- Preset counter: Any reset (or other start value) of the display

Thermostat functions

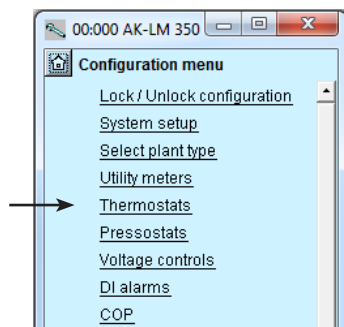

We have not used this function in our example. The image is included for guidance only. The name of the function may be xx and further down in the display the alarm texts may be entered.

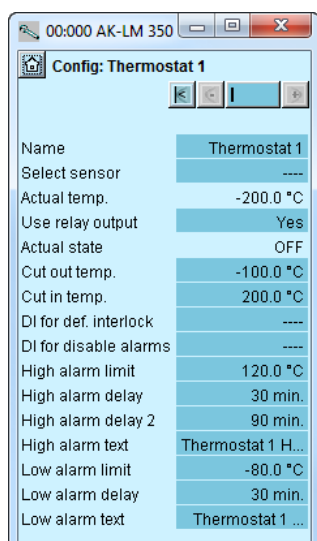

Thermostats

The general thermostats can be used to monitor the temperature.

For each thermostat set / readout

- Name
- Which of the sensors is used
- **Actual temp.**
Temperature measurement on the sensor that is attached to the thermostat
- **Used relay output**
Define whether a relay will be used for this thermostat function.
- **Actual state**
Actual status on the thermostat outlet
- **Cut out temp.**
Cut-out value for the thermostat
- **Cut in temp.**
Cut-in value for the thermostat
- **DI for def. Interlock**
DI signal, which will change the delay time to "High Alarm delay 2"
- **DI for disable alarms**
DI signal, which cancels alarms
- **High alarm limit**
High alarm limit
- **Alarm delay high**
Time delay for high alarm
- **High alarm delay 2**
Current delay time when there is a signal on "DI for def. Interlock"
- **Alarm text high**
Indicate alarm text for the high alarm
- **Low alarm limit**
Low alarm limit
- **Alarm delay low**
Time delay for low alarm
- **Alarm text low**
Indicate alarm text for low alarm

Pressostat functions

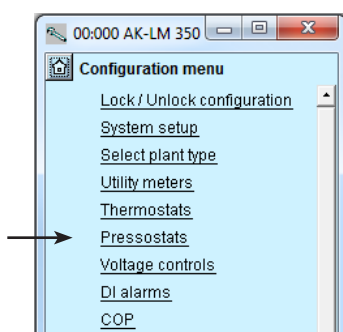

We have not used this function in our example. The image is included for guidance only. The name of the function may be xx and further down in the display the alarm texts may be entered.

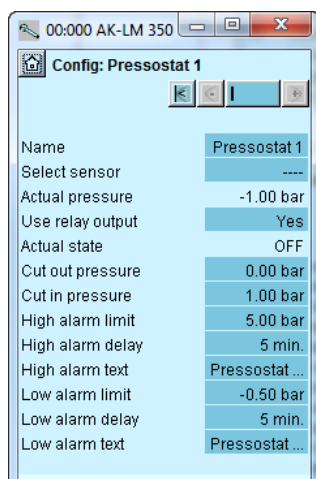

Pressostats

The general pressostats can be used to monitor the pressure (Abs. pressure)

For each pressostat set / readout

- Name
- Which of the sensors is used
- **Actual pressure.**
Pressure reading on the sensor connected to the pressure switch
- **Used relay output**
Define whether a relay is to be used for this pressure switch function
- **Actual state**
Actual status on the pressostat outlet
- **Cut out pressure**
Cut-out value for the pressostat
- **Cut in pressure**
Cut-in value for the pressostat
- **High alarm limit**
High alarm limit
- **Alarm delay high**
Time delay for high alarm
- **Alarm text high**
Indicate alarm text for the high alarm
- **Low alarm limit**
Low alarm limit
- **Alarm delay low**
Time delay for low alarm
- **Alarm text low**
Indicate alarm text for low alarm

Voltage controls

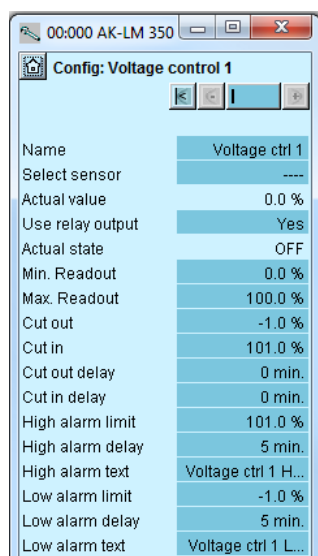
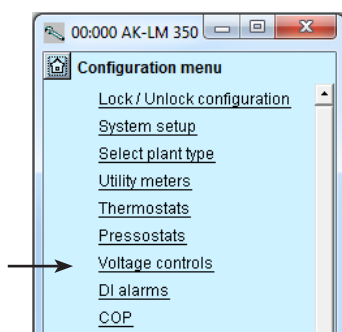

We have not used this function in our example. The image is included for guidance only.
The name of the function may be xx and further down in the display the alarm texts may be entered.

3 - Voltage inputs

The general volt inlet can be used to monitor external voltage signals.

For each volt inlet setup /readout:

- **Name**
- **Actual value**
= read-out of the measurement in %
- **Use relay output**
Define whether a relay must be used for this voltage function.
- **Actual state**
= read-out of outlet status
- **Min. readout**
State read-out values at minimum voltage signal
- **Max. readout**
State read-out values at maximum voltage signal
- **Cutout**
Cut-out value for outlet (scaled value)
- **Cutin**
Cut-in value for outlet (scaled value)
- **Cutout delay**
Time delay for cut-out
- **Cut in delay**
Time delay for cut-in
- **High alarm limit**
High alarm limit
- **High alarm delay**
Time delay for high alarm
- **High alarm text**
Set alarm text for high alarm
- **Low alarm limit**
Low alarm limit
- **Low alarm delay**
Time delay for low alarm
- **Low alarm text**
Indicate alarm text for low alarm

Digital alarms

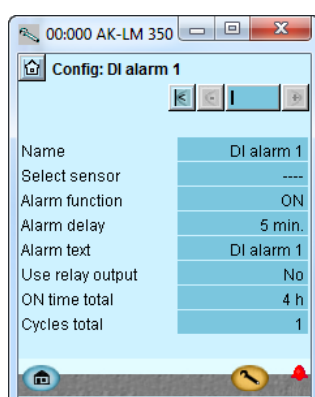
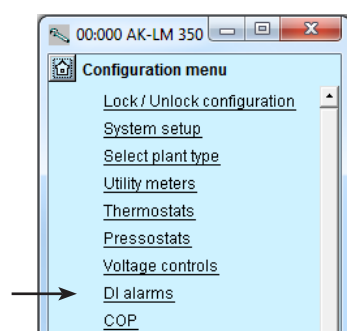

We have not used this function in our example. The image is included for guidance only.
The name of the function may be xx and further down in the display the alarm texts may be entered.

DI alarms

- Name
- Select sensor
- Alarm function
Start or stop of the alarm function.
- Alarm delay
- Alarm text
- Use relay output
Specify if a relay is to be used for this alarm function.
- ON time total
Here the user can see how long the function has been in alarm mode. All ON times are summed up. It is possible to reset or change the read-out.
- Cycles total
Here the user can see how many times the alarm has occurred. It is possible to reset or change the read-out.

COP calculation

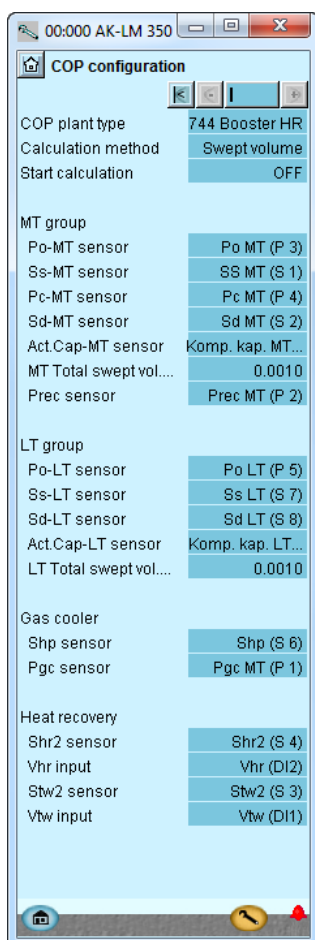
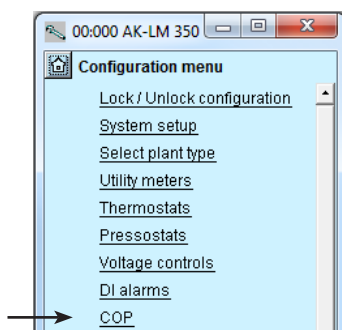

In chapter 6, there are drawing examples of the required COP signals for the various types of systems.

In our example we select the settings shown.

The example constitutes a booster system with heat recovery. It requires signals from all of the sensors displayed.

The sensor name in the blue fields comes from the "I/O configuration". The data in parentheses is only for orientation and can be dispensed with.

S1 to S8 are temperature sensors; P1 to P5 are pressure transmitters; DI1 to DI2 are on/off signals; and the compressor capacity consists of voltage signals V1 and V2.

COP calculation

The function calculates the COP based on the readings received, and it compares the data with the theoretically ideal situation.

• COP Plant type

You can choose between the following 5 types of systems:

- 744 booster
- 744 booster with heat recovery
- 744 booster with heat recovery and brine
- Cascade plant
- Single plant

• Calculation method

- Power calculation (requires signal from energy meters)
- Circulation (swept volume)

• Start calculation

• Sensors

There must be a signal from the sensors listed.

• Pressure transmitters

There must be a signal from the sensors listed.

• Act. cutin compressor capacity

A voltage signal must be received from the compressor control. The signal indicates the percentage of connected compressor capacity.

• Swept volume

Record the total volume flow of the current compressor group in m³/second.

• Power meter

Define the connection point if the calculation is to be made via power measurement.

• Refrigerant

Set the refrigerant to CO2 for the three types of systems. Set the current refrigerant for the two other systems.

The following refrigerants are possible:

- R134a
- R170
- R290
- R404A
- R407C
- R410A
- R507
- R600a
- R717
- R744
- R1270

• Heat recovery and 3-ways valves

Define both sensors if there is heat recovery for both utility water and room heating. If only one of the two heat recovery units is used, leave out the sensor setting for the second.

The controller must know if the valve is sending gas through the heat exchanger, or if the gas is bypassing it. This should be done with an on/off signal.

Configuration of inputs and outputs

1. Go to Configuration menu

2. Select I/O configuration

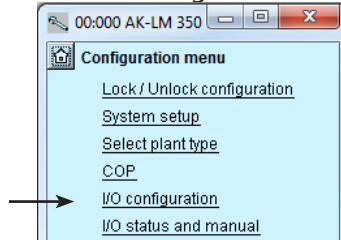

3. Configuration of Digital outputs

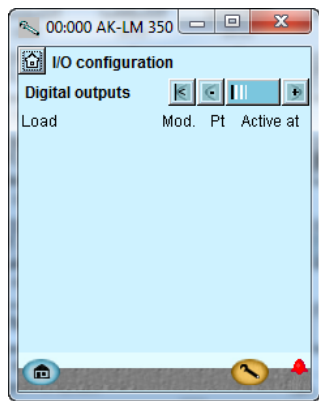

Press the + -button to go on to the next page

4. Setup On/off input functions

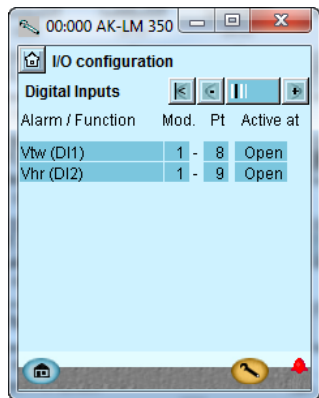

Press the + -button to go on to the next page

The following displays will depend on the earlier definitions. The displays will show which connections the earlier settings will require. The tables are the same as shown earlier.

- Digital outputs
- Digital inputs
- Analog inputs

Relay outlets are not used in our example.

ON / OFF outputs	Output	Module	Point	Active at
	DO1	1	12	
	DO2	1	13	
	DO3	1	14	
	DO4	1	15	
	DO5	1	16	
	DO6	1	17	
	DO7	1	18	
	DO8	1	19	

We set up the controller's digital outputs by keying in which module and point on this module each one of these has been connected to.

We furthermore select for each output whether the load is to be active when the output is in pos. **ON** or **OFF**.

(Functions with relay:

A relay connection was reserved for each function when the number of functions was defined. Keep the 0-0 setting for those functions that are not going to use a relay connection. The line is removed automatically when set up of the function continues).

ON / OFF input signals	Input	Module	Point	Active at
Valve position Vtw	AI8	1	8	Open
Valve position Vhr	AI9	1	9	Open

We set up the controller's digital input functions by keying in which module and point on this module each one of these has been connected to.

We furthermore select for each output whether the function is to be active when the output is in pos. **Closed** or **Open**.

All inputs are shown as DI1, DI2, etc.
We will change this name to the respective functions.
As such, DI1 will become Vtw (DI1), and DI2 will become Vhr (DI2).

3 - Outputs

The possible functions are the following:

- Alarm, high priority
- Alarm, all priority
- Thermostat 1 - 5
- Pressostat 1 - 5
- Voltage input 1 - 5

4 - Digital inputs

Alarm mute:

Only shown if an alarm relay has been defined and it needs to be fitted with a switch function (pulse pressure).

DI 1- 16:

Definition of on/off inputs.

Synchronisation signal:

Only shown if a pulse reading with related synchronisation is defined. A synchronisation signal can be connected to the pulse module.

Pulse reading:

Here pulse measurements can be connected in accordance with DIN 43864.

5. Configuration of Analog inputs signals

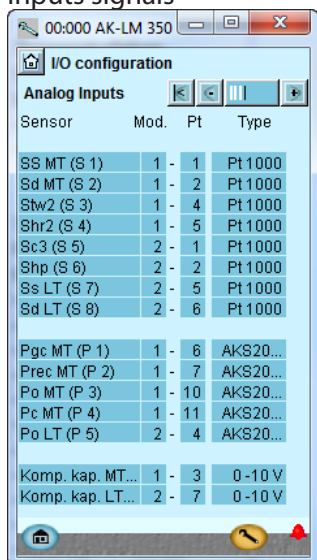

Analoge signals	Inlet	Module	Point	Type
Ss MT	AI1	1	1	Pt 1000
Sd MT	AI2	1	2	Pt 1000
Comp. capacity MT	AI3	1	3	0-10 V
Stw2	AI4	1	4	Pt 1000
Shr2	AI5	1	5	Pt 1000
Pgc MT	AI6	1	6	AKS 2050-159
Prec MT	AI7	1	7	AKS 2050-159
	AI8	1	8	
	AI9	1	9	
Po MT	AI10	1	10	AKS 2050-59
Pc MT	AI11	1	11	AKS 2050-159
Sc3	AI1	2	1	Pt 1000
Shp	AI2	2	2	Pt 1000
	AI3	2	3	
Po LT	AI4	2	4	AKS 2050-59
Ss LT	AI5	2	5	Pt 1000
Sd LT	AI6	2	6	Pt 1000
Comp. capacity LT	AI7	2	7	0-10 V
	AI8	2	8	

We set up the analog inputs for the sensors, pressure transmitters and voltage signals.

5 - Analog inputs

The possible signals are the following:

Temperature sensors:

S1 - S40

Setting:

- Pt1000
- PTC 1000

Pressure transmitters::

P1 - P20

Setting:

- AKS 32, -1 – 6 Bar
- AKS 32R, -1 – 6 Bar
- AKS 32, -1 – 9 Bar
- AKS 32R, -1 – 9 Bar
- AKS 32, -1 – 12 Bar
- AKS 32R, -1 – 12 Bar
- AKS 32, -1 – 20 Bar
- AKS 32R, -1 – 20 Bar
- AKS 32, -1 – 34 Bar
- AKS 32R, -1 – 34 Bar
- AKS 32, -1 – 50 Bar
- AKS 32R, -1 – 50 Bar
- AKS 2050, -1 – 59 Bar
- AKS 2050, -1 – 99 Bar
- AKS 2050, -1 – 159 Bar
- User defined (only ratio-metric. The min. and max. values of the pressure interval must be set).

Voltage signals:

Voltage input 1 - 20

Setting:

- 0 - 5
- 1 - 5
- 0 - 10
- 2 - 10

Set alarm priorities

1. Go to Configuration menu

2. Select Alarm priorities

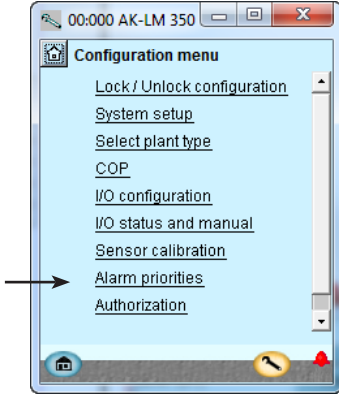

3. Set priorities for Sensor error

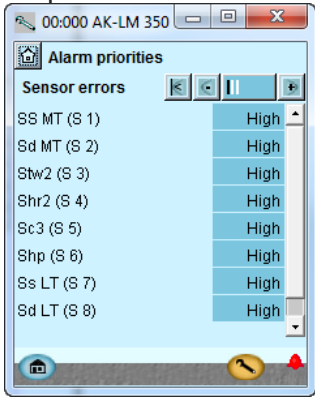

Press the + -button to go on to the next page

4. Set alarm priorities for "Various"

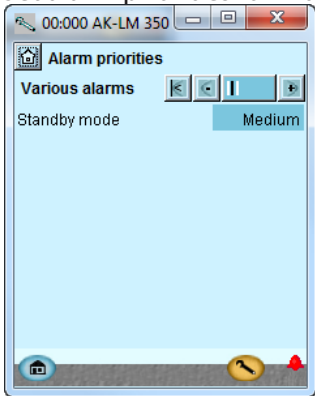

Press the + -button to go on to the next page

Very many functions have an alarm connected. Your choice of functions and settings has connected all the relevant alarms that are current. They will be shown with text in the three pictures.

All alarms that can occur can be set for a given order of priority:

- "High" is the most important one
- "Log only" has lowest priority
- "Disconnected" gives no action

The interdependence between setting and action can be seen in the table.

Setting	Log	Alarm relay selection				Net-work	AKM-dest.
		Non	High	Low-middle	Low - High		
High	X		X		X	X	1
Medium	X			X	X	X	2
Low	X			X	X	X	3
Log only	X						
Discon-nected							

In our example we select the settings shown here in the display

In our example we select the settings shown here in the display

5. Set alarm priorities for General alarms

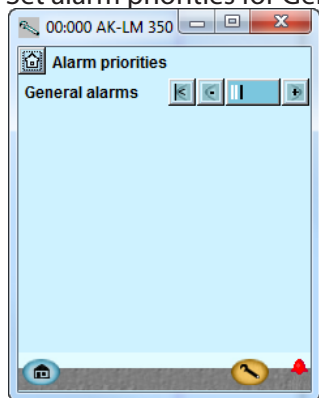

There are no general alarm functions in our example.

Check of settings

1. Go to the overview

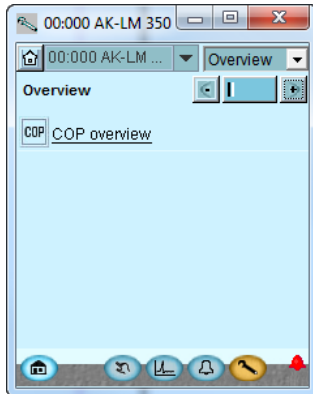

2. Select COP



3. Overviews for COP

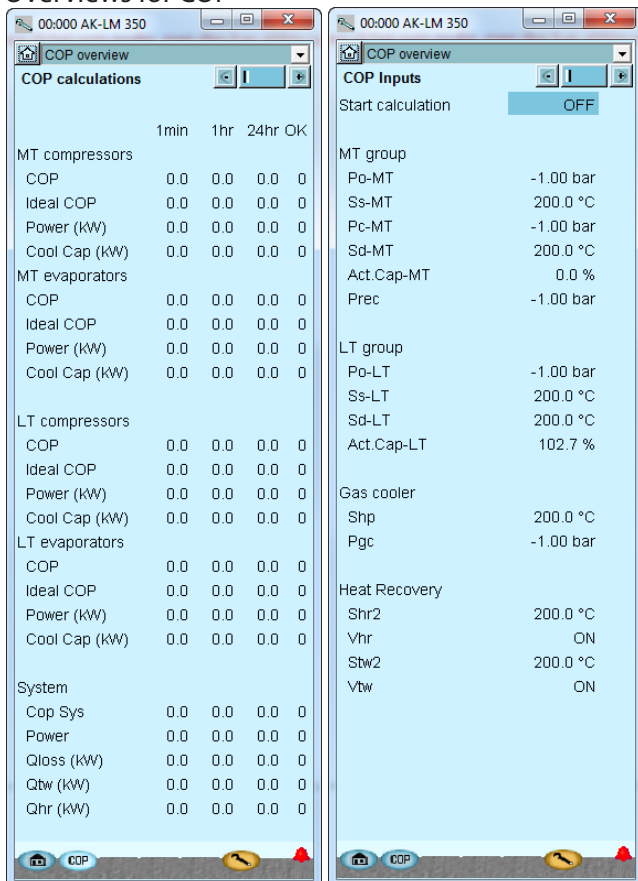

Before the control starts, we check that all the settings are as they should be.

The overview display will now show one line for each of the general functions. Behind each icon there is a number of displays with the different settings. It is all these settings that have to be checked. In our example, we have only selected COP calculation.

The following functions can be selected:

- Utility meters
- Thermostats
- Pressostats
- Voltage controls
- DI alarms
- COP overview

The COP function is displayed on this page, and on the following pages; the others are only displayed for orientation purposes.

A COP value should be as high as possible, but it can never exceed the ideal value.

Left screen, column 5:

OK = 0 or 1. The value indicates whether the calculation is valid.

0 = invalid calculation

1 = valid calculation

The COP calculation may be invalid if there is a time delay in a compressor change, where the temperature sensors are not able to adjust to the correct temperature, and the subsequent calculation uses the correct reading.

If, over a period of time, there are several invalid calculations, the system should be inspected for unstable operation.

If the compressor regulation is performed by an AK-PC 772, and the "hot gas dump" function is activated, the COP calculation will not be correct.

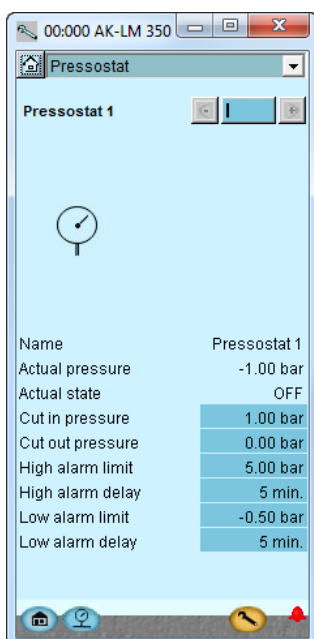
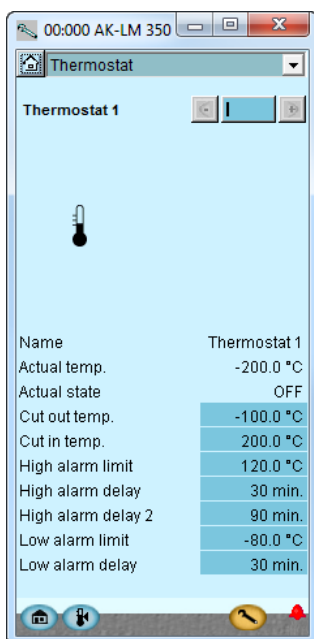
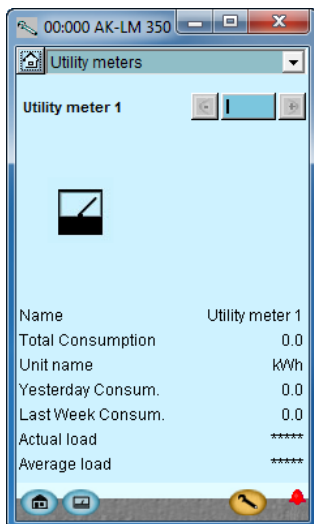

8. Move on to settings for pressostat 1

The measurement can be monitored in the five fields. These display the total consumption, the current load and the average load over the period of time.

If the thermostat's alarm function is to be changed temporarily during daily operation, two digital signals can be connected:

- Defrosting signal. Signal on the DI input entails change to Delay Time 2.
- Alarm stop. Signal on the DI input stops alarms.

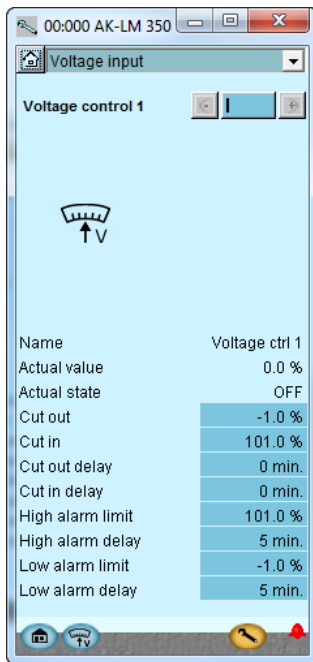

Scaled values

The input signal is scaled, so it is displayed in %.

Cut-in and cut-out values and alarm settings refer to the scaled values.

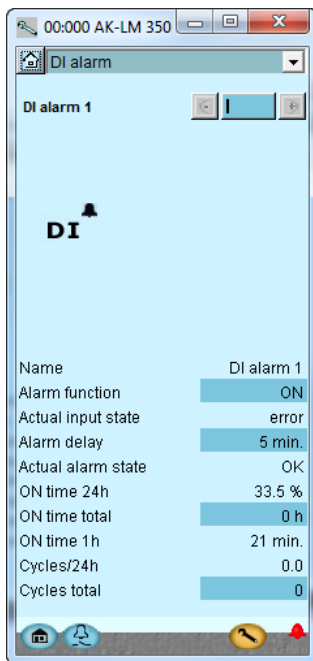

The status of the alarm is shown on the 'current alarm status' line. This status display is delayed with 'alarm delay' for the input signal.

Signal history

The level of the input is continuously recorded so that the following can be read:

- On time in % for the last 24 hours
- Total On time in hours
- Number of changes to On in the last 24 hours
- Total number of changes to On

Lock configuration

1. Go to Configuration menu
2. Select Lock/Unlock configuration

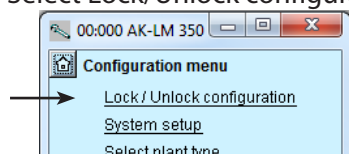

3. Lock Configuration

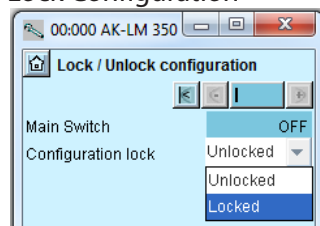

The controller will now make a comparison of selected functions and define inputs and outputs. The result can be seen in the next section where the setup is controlled.

Press in the field against **Configuration lock**.

Select **Locked**.

The setup of the controller has now been locked. If you subsequently want to make any changes in the controller's setup, remember first to unlock the configuration.

Check configuration

1. Go to Configuration menu

2. Select I/O configuration

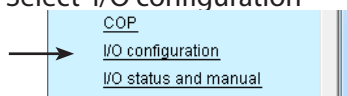

3. Check configuration of Digital Outputs

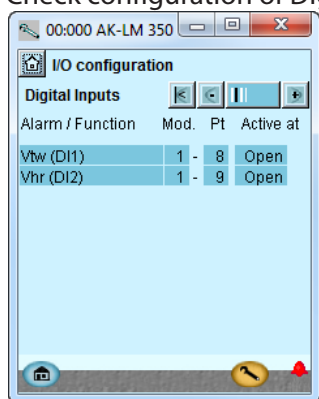

Press the + -button to go on to the next page

4. Check configuration of Analog inputs

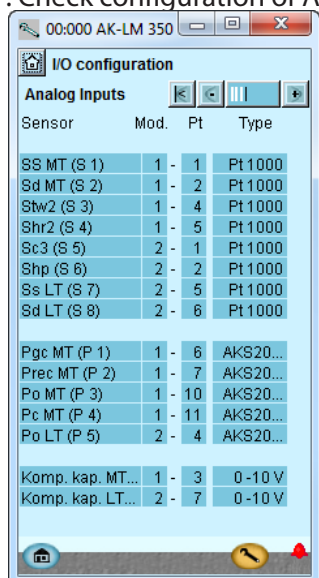

This control requires that the setup is locked

(Only when the setup is locked are all settings for in- and outputs activated.)

The setup of the digital outputs appears as it is supposed to according to the wiring made.

The setup of the analog inputs appears as it is supposed to according to the wiring made.

An error has occurred, if you see the following:



A **0 - 0** next to a defined function. If a setting has reverted to 0-0, you must control the setup again.

This may be due to the following:

- A selection has been made of a combination of module number and point number that does not exist.
- The selected point number on the selected module had been set up for something different.

The error is corrected by setting up the output correctly.

Remember that the setup must be unlocked before you can change module and point numbers..



The settings are shown on a **RED** background. If a setting has turned red, you must control the setup again.

This may be due to the following:

- The input or the output has been set up; but the setup has later been changed so that it should no longer be applied.

The problem is corrected by setting **module number to 0 and point number to 0.**

Remember that the setup must be unlocked before you can change module and point numbers.

Check of connections

1. Go to Configuration menu

2. Select I/O status and manual

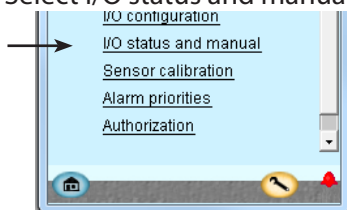

3. Check Digital Outputs

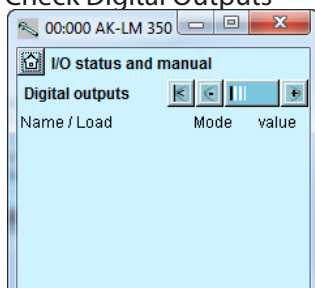

Press the +-button to go on to the next page

4. Check Digital Inputs

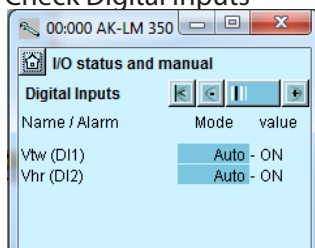

Press the +-button to go on to the next page

5. Check Analog inputs

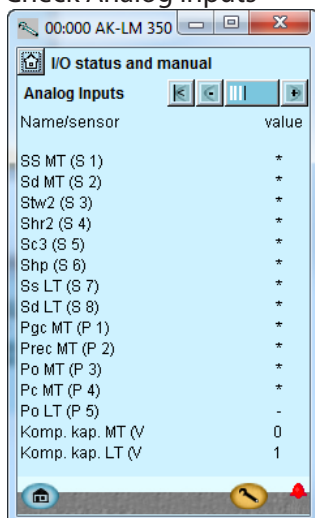

Before the control is started we check that all inputs and outputs have been connected as expected.

This controls requires that the setup is locked

By means of the manual control of each output it can be checked whether the output has been correctly connected.

AUTO	The output is controlled by the controller
MAN OFF	The output is forced to pos. OFF
MAN ON	The output is forced to pos ON

Activate the various functions (the door switch and the main switch). Check that the controller registers the activation – i.e. whether the ON/OFF value is changed in the last column. Check the other digital inputs in the same way.

Check that all sensors show sensible values.

In our case we have no value. This may be due to the following:

- The sensor has not been connected.
- The sensor is short-circuited/interrupted
- The point or module number has not been set up correctly.
- The configuration is not locked.

Installation in network

1. Set the address (here, for example 3)

Turn the right-hand address switch so that the arrow will point at 3.

The arrow of the two other address switches must point at 0.

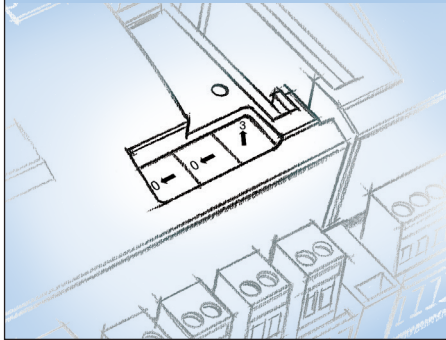

2. Push the Service Pin

Press down the service pin and keep it down until the Service Pin LED lights up.

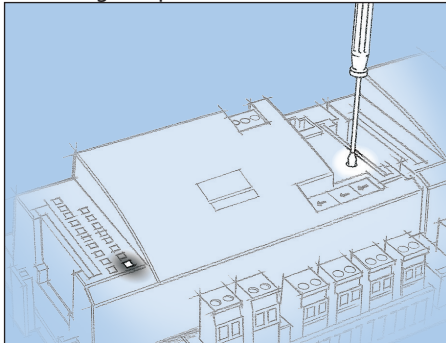

3. Wait for answer from the system unit

Depending on the size of the network it may be up to one minute before the controller receives an answer as to whether it has been installed in the network.

When it has been installed the Status LED will start to flash faster than normal (once every half second). It will continue with this for about 10 minutes

4. Carry out new login via Service Tool



If the Service Tool was connected to the controller while you installed it in the network, you must carry out a new login to the controller via the Service Tool.

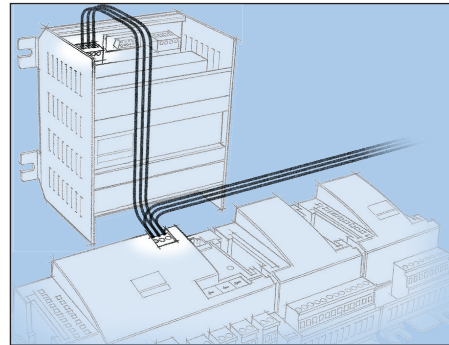

The controller has to be remote-monitored via a network. In this network we assign address number 3 to the controller.

The same address must not be used by more than one controller in the same network.

Requirement to the system unit

The system unit must be a gateway type AKA 245 with software version 6.0 or higher. It is capable of handling up to 119 AK controllers.

Alternatively, it can be an AK-SM 720. It is capable of handling up to 200 AK controllers.

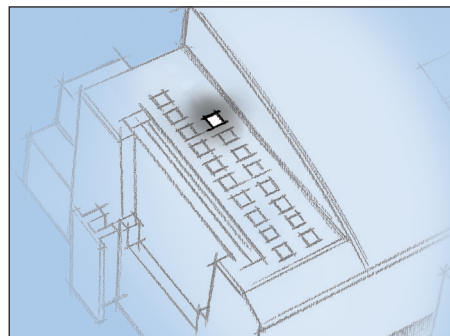

If there is no answer from the system unit

If the Status LED does not start flashing faster than normal, the controller has not been installed in the network. The reason for this may be one of the following:

The controller has been assigned an address out of range

Address 0 cannot be used.

If the system unit in the network is an AKA 243B Gateway only the addresses between 1 and 10 can be used.

The selected address is already being used by another controller or unit in the network:

The address setting must be changed to another (vacant) address.

The wiring has not been carried out correctly.

The termination has not been carried out correctly.

The data communication requirements are described in the document: "Data communication connections to ADAP-KOOL® Refrigeration Controls" RC8AC.

First start of control

Check alarms

1. Go to the overview



Press the blue overview button at the bottom left of the display.

2. Go to the Alarm list



Press the blue button with the alarm bell at the bottom of the display.

3. Check active alarms

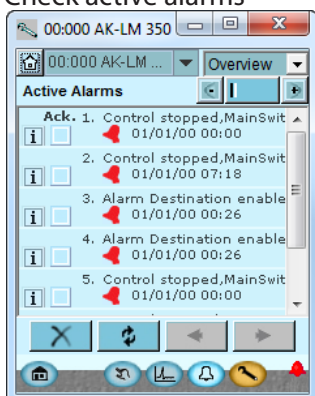

In our case, we have a series of alarms. We will tidy them up so that we only have those that are relevant.

4. Remove cancelled alarm from the alarm list

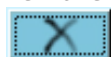

Press the red cross to remove cancelled alarms from the alarm list.

5. Check active alarm again

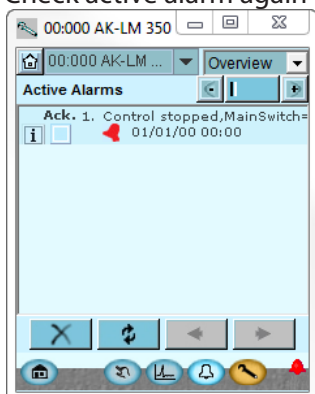

In our case an active alarm remains because the control has stopped. This alarm must be active when control has not started. We are now ready for the startup of control.

Please note that active plant alarms are automatically cancelled when the main switch is in pos. OFF. If active alarms appear when the control is started the reason for these should be found and remedied.

Start the control

1. Go to Start/Stop display



Press the blue manual control button at the bottom of the display.

2. Start control

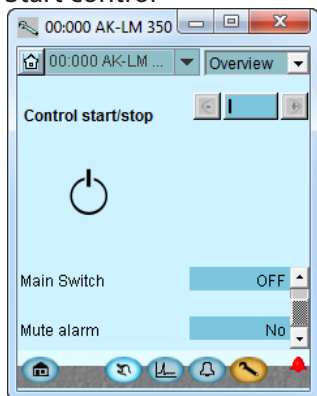

Press in the field against **Main switch**.
Select **ON**.

If the alarm relay is enabled, the alarm relay can be reset using this function.
Remember to investigate where the alarm comes from.

Setup logs

1. Go to the overview



Press the blue overview button with the log symbol.

2. Log display

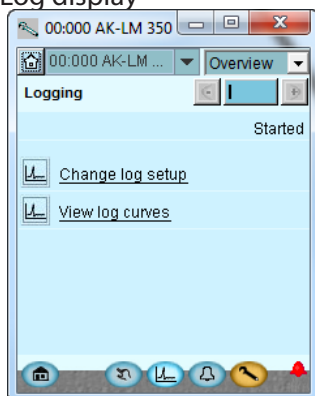

3. New logs

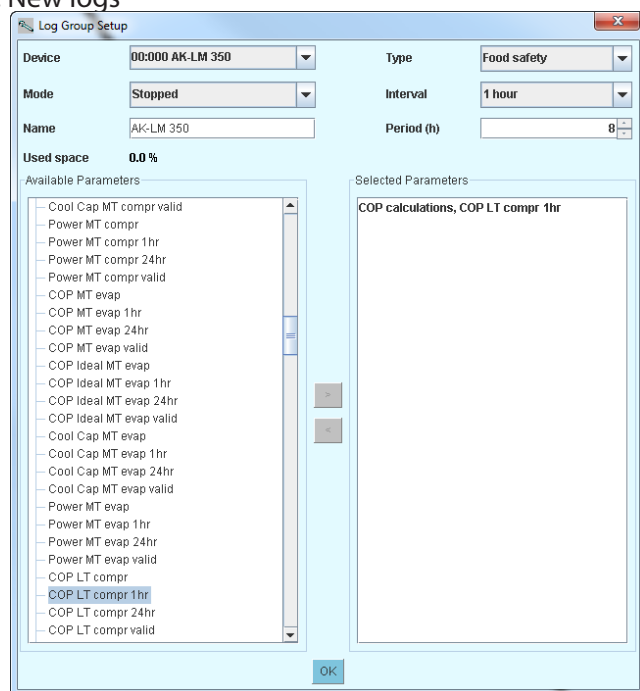

4. Selection of parameters

If data need to be collected from some of the set parameters, this should be done using a logo setting in a system manager. This can store a larger amount of data.

If you want to set up a log in the monitoring unit, consider the following:

The log function **requires** that the clock function is **set**. Even a minor power failure will stop the clock.

If you want to ensure that the clock is always set, the controller must either be installed in a network together with a system unit or a battery module must be installed.

The top line gives access to definition of new logs and to changes of already established logs.

The next line enables you to see a selection of the defined logs

Here is the start display for new logs

Start by defining which type of log has to be defined

Here it is determined which parameters have to be included in the setup of data. Select a function here, then a parameter, and finish with OK.

A LOG CAN ONLY BE DISPLAYED IF:

- THE CLOCK HAS BEEN SET AND
- THE CONFIGURATION IS LOCKED

5. Regulating functions

This section describes how the different functions work

Monitoring functions

Thermostats (5 units)

The function may freely be used for:

- Temperature registration
- Temperature monitoring with alarm function
- Temperature control with relay function

An example could be thermostat control of the fan in the compressor compartment.

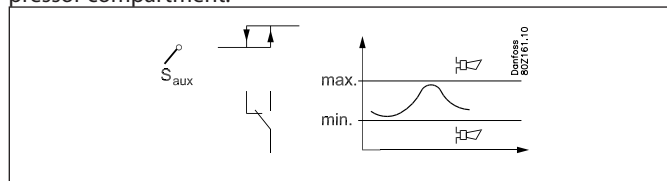

The thermostat can be used as one of the sensors S1, S2, S3, .. etc. Cutin and cutout limits are set for the thermostat. Coupling of the thermostat's output will be based on the actual sensor temperature. Alarm limits can be set for low and high temperature, respectively, including separate alarm delays. The individual thermostat function can be adapted to the relevant application as it is possible to give the thermostat a name and to indicate alarm texts.

Each thermostat function can also detect two digital signals which can be used to change alarm signals.

One signal that will change the alarm delay so that a change is made to the long alarm delay. This signal is primarily used with a defrosting so that no alarm is triggered during a defrosting.

A signal that stops the alarm. This signal is primarily used during stoppage of a refrigeration appliance, e.g. during cleaning.

Each thermostat has the following available functions:

- Name
- Sensor signal
- Display of the current reading
- Selection of relay function
- Setting the cut-out value for relays
- Setting the cut-in value for relays
- Selection of the input signal that changes to Alarm Delay 2
- Selection of the input signal that stops alarms
- High alarm limit
- Delay time for 'high alarm'
- Delay time 2 for 'high alarm'
- Alarm text for 'high alarm'
- Low alarm limit
- Delay time for 'low alarm'
- Alarm text for 'low alarm'

Pressostats (5 units)

The function may freely be used for:

- Pressure registration
- Pressure monitoring with alarm function
- Pressure control with relay function

An example could be pressure control of a vessel:

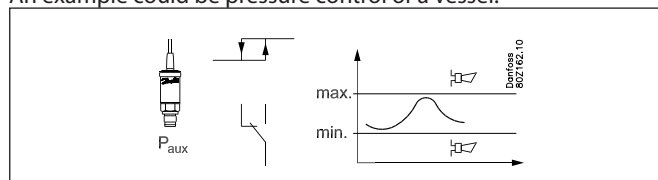

The pressostat can use one of the pressure transmitters P1, P2, P3... etc.

Set cut-in and cut-out limits for the pressostat. The pressostat output is connected based on the current pressure.

Alarm limits can be set for low and high pressure including separate alarm delays.

The individual pressostat function can be adapted to the current use as it is possible to name the pressostat control and customise alarm texts.

Each pressostat has the following available functions:

- Name
- Pressure signal
- Display of the current reading
- Selection of relay function
- Setting the cut-out value for relays
- Setting the cut-in value for relays
- High alarm limit
- Delay time for 'high alarm'
- Alarm text for 'high alarm'
- Low alarm limit
- Delay time for 'low alarm'
- Alarm text for 'low alarm'

Voltage signals (5)

The function can be used for:

- Voltage detection
- Voltage monitoring with alarm function
- Voltage monitoring with relay function

An example could be monitoring of a leak detector

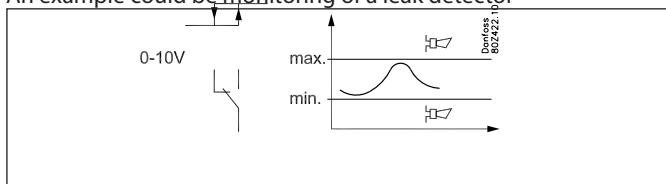

The function can use one of the voltage readings V1, V2, V3,... etc.

The following signals can be received:

- 0-5 V
- 1-5 V
- 0-10 V
- 2-10 V

A current signal can also be detected if external resistances are placed on the input so that the signal is adapted.

The signal is scaled. E.g. to 0 for min. value and 100 for max. value.

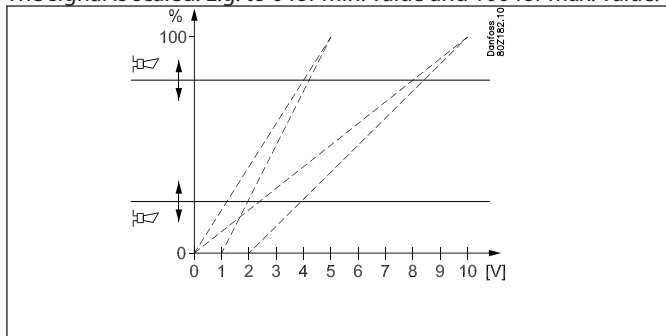

The function uses the scaled values for settings and readings.

Cut-in and cut-out limits are set for the relay. The relay is connected based on the current live voltage.

Alarm limits can be set for low and high values including separate alarm delays.

The individual functions can be adapted to the current use as it is possible to name the function and customise alarm texts.

Each voltage control has the following available functions:

- Name
- Display of the current reading
- Selection of relay function
- Display value that represents the input signal's min. value
- Display value that represents the input signal's max. value
- Setting the cut-out value for relay + delay time for cut-in
- Setting the cut-in value for relay + delay time for cut-in
- High alarm limit
- Delay time for 'high alarm'
- Alarm text for 'high alarm'
- Low alarm limit
- Delay time for 'low alarm'
- Alarm text for 'low alarm'

Alarm inputs (on/off signals)(16)

This function can be used to monitor an external signal.

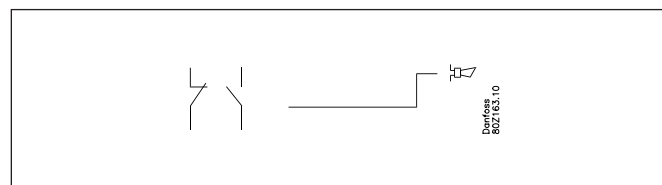

The function can receive the following signals:

- 0 / 24 V on a low voltage DI input
- 0 / 230 V on a high voltage DI input
- Open/closed input for an analogue input

Each alarm input has the following available functions:

- Name
- Reading of the current status of the input (the overview display)
- Selection of alarm function
- Selection of relay function
- Delay time from detection to alarm and relay change
- Reading of the current status of the alarm
- Alarm text
- Alarm history with the following information:
 - On time in% for the last 24 hours
 - Total On time
 - Number of changes in the last 24 hours
 - Total number of changes.

Consumption reading

This function registers the consumption of electricity, water, gas, etc.

These readings are saved in the monitoring unit and can be retrieved later for presentation/analysis. An expansion module type AK-XM 107A must be used. The module is a pulse counter module, which measures pulses in accordance with DIN 43 864. Conversion from, for example, current to pulses takes place in an energy counter.

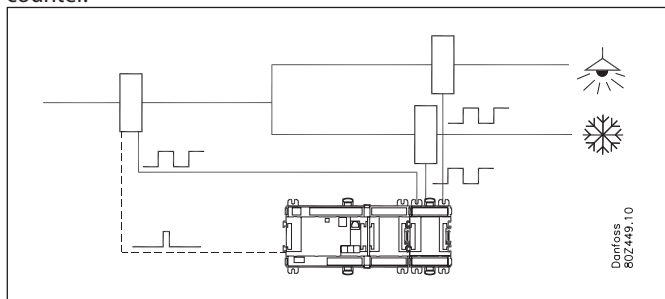

Energy counters can be divided into several groups, e.g. one main meter and several ancillary meters.

The main meter measures all of the consumption for the installation. Some main meters are fitted with tariff and synchronisation switches.

The AK-LM 350 can receive the synchronisation signal.

The synchronisation switch changes at regular intervals (typically every 15 mins) and indicates that a new measurement period has started.

Ancillary meters measure an element of consumption. It might be interesting to know, for example, the freezer department's energy consumption.

Measurement intervals for synchronisation are set jointly for all energy meters.

If the synchronisation signal is not used, the monitoring unit will define its own measurement period.

The monitoring unit supports up to 8 energy meters.

Each consumption meter has the following available functions:

- Name
- Start/stop of consumption measurement
- Setting the consumption measurement
- Setting the meter
- Selection of number of pulses per unit of measurement
- The conversion factor is defined as primary/secondary ratio
- Setting the consumption value, e.g. by installation of counter

In addition it is possible to read historical and current values:

- Total consumption (since start-up or reset the counter)
- Consumption for past week (from Monday at 0 until Sunday at 24 o'clock)
- Consumption for past day (from 0 to 24 o'clock)
- Current output (average power the last 60 seconds. Updated every 5th seconds)
- Average output (average power in the measurement interval, typically 15 minutes).

COP

Coefficient Of Performance = the relationship between the amount of cooling produced and the amount of energy consumed.

The higher the value, the better.

If the COP value drops at a constant condenser temperature, this is a sign that there are problems.

The COP can be used to compare systems of the same type. The output values provide a momentary picture of the cooling system's energy efficiency, and the values are displayed as mean values:

- Mean value over the last minute
- Mean value over the last hour
- Mean value over the last 24 hours

COP values are displayed for the MT group, the LT group and for the entire system (COPS), as well as for the ideal value for each group.

You can choose between the following 5 types of systems:

- CO₂ booster
- CO₂ booster with heat recovery
- CO₂ booster with heat recovery and brine
- Cascade system
- Single system

The calculations regard the group of MT compressors as a single MT compressor, and the group of LT compressors as a single LT compressor.

All calculations are based on the ideal theoretical cooling process and are compared with the system readings taken. Pressure readings can be retrieved from the other Danfoss controllers. Temperature readings must be obtained from separate sensors. The following measurements are required:

- Outdoor temperature
- Temperature and pressure before the compressor (Ss and Po)
- Temperature and pressure after the compressor (Sd and Pc)
- For booster +*
- Pressure in receiver (Prec)
- Gas pressure and temperature after gas cooler (Pgc and Shp)
- For heat recovery +*
- Gas temperature after heat exchanger (Stw2 and Shr)
- Position of three-way valves, on or bypass. (Vtw and Vhr)
- For cascade +*
- Temperatures on LT side of heat exchanger (Scasc3)
- Temperature after condenser (S2cond)
- For single +*
- Temperature after condenser (S2cond)

In chapter 6, there are examples of systems and related signals.

As well as data for the compressor capacity:

- Swept volume (sum of all compressors in the group)
- It is important that the value of the volume flow is as precise as possible.

For a more precise calculation than that provided by the aforementioned readings, current measurements can be connected so that the controller knows how much power the compressors are consuming. See energy consumption reading.

For cascade systems and single systems, the refrigerant must also be set. Choose from among the following:

R134a, R170, R290, R404A, R407C, R410A, R507, R600a, R717, R744, R1270.

(R744 **cannot** be selected for cascade systems.)

Miscellaneous

Main switch

The main switch is used to stop and start the controlling function. The switch-over has 2 positions:

- Normal controlling state (Setting = ON)
- Control stopped. (Setting = OFF)

If the main switch is set at OFF, all the control's functions are inactive and an alarm is generated to draw attention to this – all other alarms cease.

Sensor calibration:

The input signal from all connected sensors can be corrected. A correction will only be necessary if the sensor cable is long and has a small cross-sectional area. All displays and functions will reflect the corrected value.

Clock function

The controller contains a clock function. The clock function is used by the Log function. The year, month, date, hour and minutes must be set. Note: If the controller is not equipped with a RTC module (AK-OB 101A) the clock must be reset after each mains voltage outage. If the controller is connected to an installation with an AKA-gateway or an AK system manager, this will automatically reset the clock function.

Alarms and messages

In connection with the controller's functions, there are a number of alarms and messages that become visible in cases of fault or erroneous operation.

Alarm history:

The controller contains an alarm history (log) that contains all active alarms as well as the last 40 historical alarms. In the alarm history you can see when the alarm began and when it stopped. In addition, one can see the priority of each alarm as well as when the alarm has been acknowledged and by which user.

Alarm priority:

Differentiation is made between important and not-so-important information. The importance – or priority – is set for some alarms whilst others can be changed voluntarily (this change can only be done with attachment of AK-ST service tool software to the system and settings must be made in each individual controller).

The setting decides which sorting / action must be carried out when an alarm is sounded.

- "High" is the most important
- "Log only" is the lowest
- "Interrupted" results in no action

Alarm relay

If the controller must give an alarm on a relay output the relay must be defined:

2 relays can be defined:

- One which is active at alarms with priority "high"
- One which is active at alarms with the priority "low", "middle" and "high".

The relationship between alarm priority and action appears in the schedule below.

Setting	Log	Alarm relay selection				Net-work	AKM-dest.
		Non	High	Low-middle	Low-high		
High	X		X		X	X	1
Medium	X			X	X	X	2
Low	X			X	X	X	3
Log only	X						
Discon- nected							

An alarm disappears when acknowledged or it ceases by itself.

Alarm acknowledgement

If the controller is connected to a network with an AKA gateway or an AK system manager as alarm receiver, these will automatically acknowledge the alarms that are sent to them.

If the controller on the other hand is not included in a network, the user must acknowledge all alarms.

Alarm LED

The alarm LED on the front of the controller indicates the controller's alarm status.

Blinking: There is an active alarm or an unacknowledged alarm.

Fixed light: There is an active alarm that has been acknowledged.

Switched off: There are no active alarms and no unacknowledged alarms.

IO Status and manual

The function is used in connection with installation, servicing and fault-finding on the equipment.

With the help of the function, the connected outputs are controlled.

Measurements

The status of all inlets and outlets can be read and controlled here.

Forced operation

One can carry out an override of all outlets here to control whether these are correctly attached.

Note: There is no monitoring when the outlets are overridden.

Logging/registration of parameters

As a tool for documentation and fault-finding, the controller provides the possibility of logging of parameter data in the internal memory.

Via AK-ST 500 service tool software one can:

- Select up to 10 parameter values the controller will continuously register
- State how often they must be registered

The controller has a limited memory but as a rule of thumb, the 10 parameters can be saved, which are registered every 10 minutes for 2 days.

Via AK-ST 500 one can subsequently read the historical values in the form of graph presentations.

Operating AKM / Service tool

The setup of the controller itself can only be carried out via AK-ST 500 service tool software. The operation is described in fitters on site guide.

If the controller is included in a network with an AKA gateway one can subsequently carry out the daily operation of the controller via AKM system software, i.e. one can see and change daily read-outs/settings.

Note: AKM system software does not provide access to configuration settings of the controller. Measurements from all of the signals received and from the most important displays of the individual functions can be seen. All COP measurements are displayed. All alarms can be received by AKM.

Authorisation / Passwords

The controller can be operated with System software type AKM and service tool software AK-ST 500.

Both methods of operation provide the possibility for access to several levels according to the user's insight into the various functions.

System software type AKM:

The various users are defined here with initials and key word. Access is then opened to exactly the functions that the user may operate. The operation is described in the AKM manual.

Service tool software AK-ST 500:

The operation is described in fitters on site guide.

When a user is created, the following must be stated:

- a) State a user name
- b) State a password
- c) Select user level
- d) Select units – either US (e.g. °F and PSI) or Danfoss SI (°C and Bar)
- e) Select language

Access is given to four user levels.

- 1) DFLT – Default user – Access without use of password
See daily settings and read-outs.
- 2) Daily – Daily user
Set selected functions and carry out acknowledgement of alarms.
- 3) SERV – Service user
All settings in the menu system except for creation of new users
- 4) SUPV – Supervisor user
All settings including the creation of new users.

Light-emitting diodes on the controller

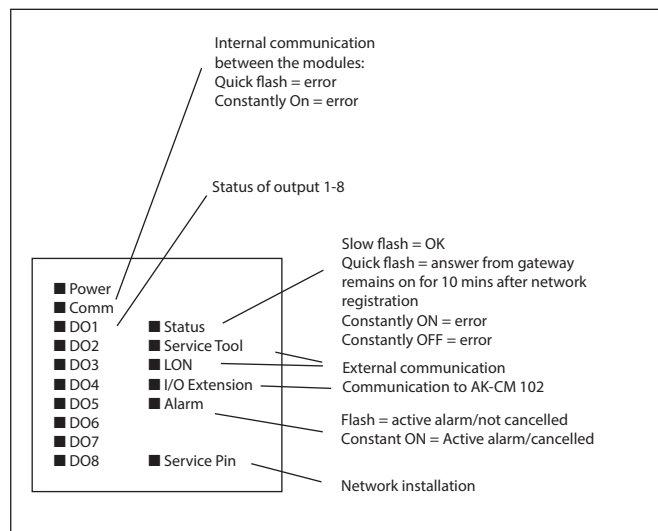

Installation considerations

Accidental damage, poor installation, or site conditions, can give rise to malfunctions of the control system, and ultimately lead to a plant breakdown.

Every possible safeguard is incorporated into our products to prevent this. However, a wrong installation, for example, could still present problems. Electronic controls are no substitute for normal, good engineering practice.

Danfoss will not be responsible for any goods, or plant components, damaged as a result of the above defects. It is the installer's responsibility to check the installation thoroughly, and to fit the necessary safety devices.

Special reference is made to the necessity of signals to the controller when the compressor is stopped and to the need of liquid receivers before the compressors.

Your local Danfoss agent will be pleased to assist with further advice, etc.

Alarm texts

Settings	Default priority		Alarm text	Description
S X sensor error (X=1-40)	High		S X sensor error	S X temp. sensor signal is faulty
P X sensor error (X=1-20)	High		P X sensor error	P X pressure transmitter signal is faulty
Standby mode	Medium		Control stopped, MainSwitch=OFF	The control has been stopped via the setting "Main switch" = ON or via the external Main switch input
Thermostat X – Low temp. alarm (X=1-5)	Medium		Thermostat X - Low alarm	Thermostat temperature has been below the set low temperature limit for longer time than set delay
Thermostat X – High temp. alarm (X=1-5)	High		Thermostat X - High alarm	Thermostat temperature has been above the set high temperature limit for longer time than the set delay
Pressostat X – Low pressure alarm (X=1-5)	Medium		Pressostat X - Low alarm	The pressure has been below the set low pressure limit for longer than the set delay
Pressostat X – alarm limit high pressure (X=1-5)	Medium		Pressostat X - High alarm	The pressure has been above the high pressure limit for longer than the set delay time
Voltage input X – Low alarm (X=1-5)	Medium		Analog input X - Low alarm	The voltage signal has been below the low alarm limit for longer time than set delay
Voltage input X – High alarm (X=1-5)	Medium		Analog input X - High alarm	The voltage signal has been above the high alarm limit for longer time than set delay
DI X alarm input (X=1-16)	Medium		DI X alarm	Alarm on general alarm input DI x

System alarms

The alarm priority can not be altered on system alarms				
	Medium		Clock has not been set	Time has not been set
	Medium		System Critical exception	A unrecoverable critical system failure has occurred – exchange the controller
	Medium		System alarm exception	A minor system failure has occurred – power off controller
	Medium		Alarm destination disabled	When this alarm is activated the alarm transmission to the alarm receiver has been deactivated. When the alarm is cleared the alarm transmission to the alarm receiver has been activated.
	Medium		Alarm route failure	Alarms can not be transmitted to alarm receiver – check communication
	High		Alarm router full	The internal alarm buffer has an overrun – this might occur if the controller can not send the alarms to the alarm receiver. Check communication between controller and AKA gateway.
	Medium		Device is restarting	The controller is restarting after flash updating of the software
	Medium		IO module error	There is a communication fault between the controller module and the extension modules – the fault must be corrected as soon as possible
	Low		MAN DI.....	The output in question has been put in manual control mode via the AK-ST 500 service tool software
	Low		MAN DO.....	The output in question has been put in manual control mode via the AK-ST 500 service tool software

6. Appendix, COP signals

CO2 Booster

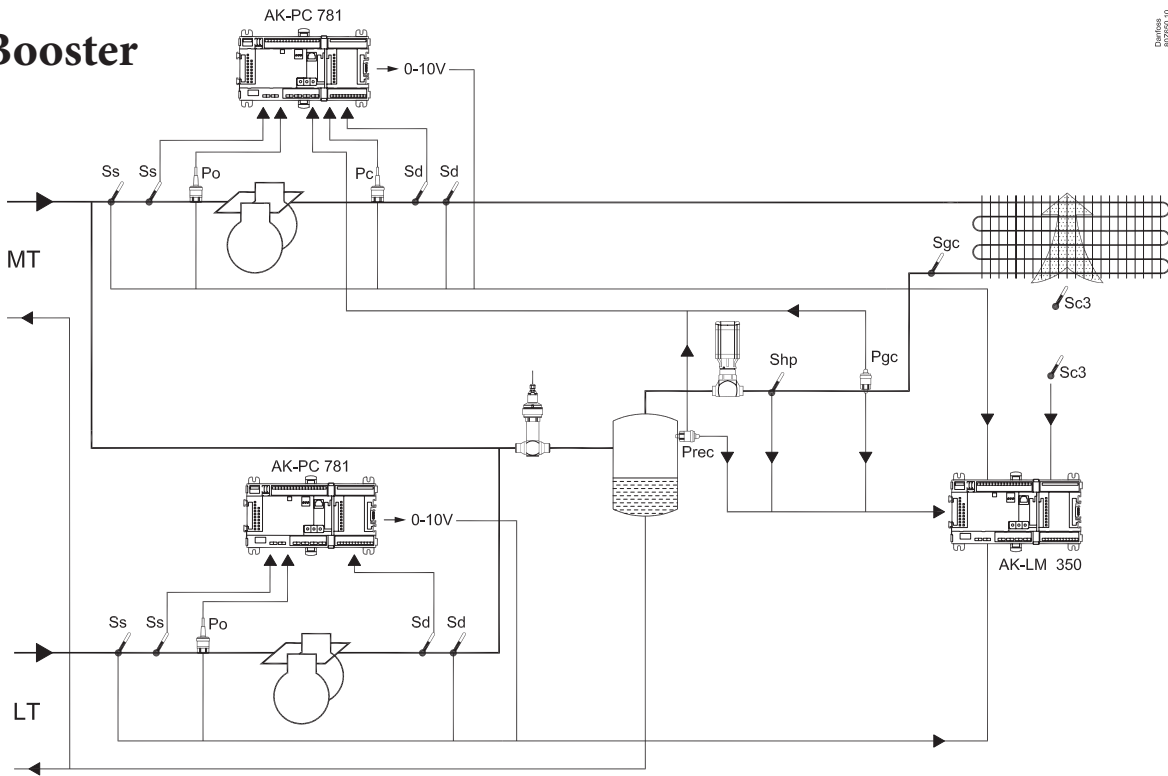

Danfoss
0282645_10

CO2 Booster HR

CO2 Booster HR Brine

Example requires:
 S = 8 pcs.
 P = 5 pcs.
 DI = 2 pcs.
 U = 2 pcs.

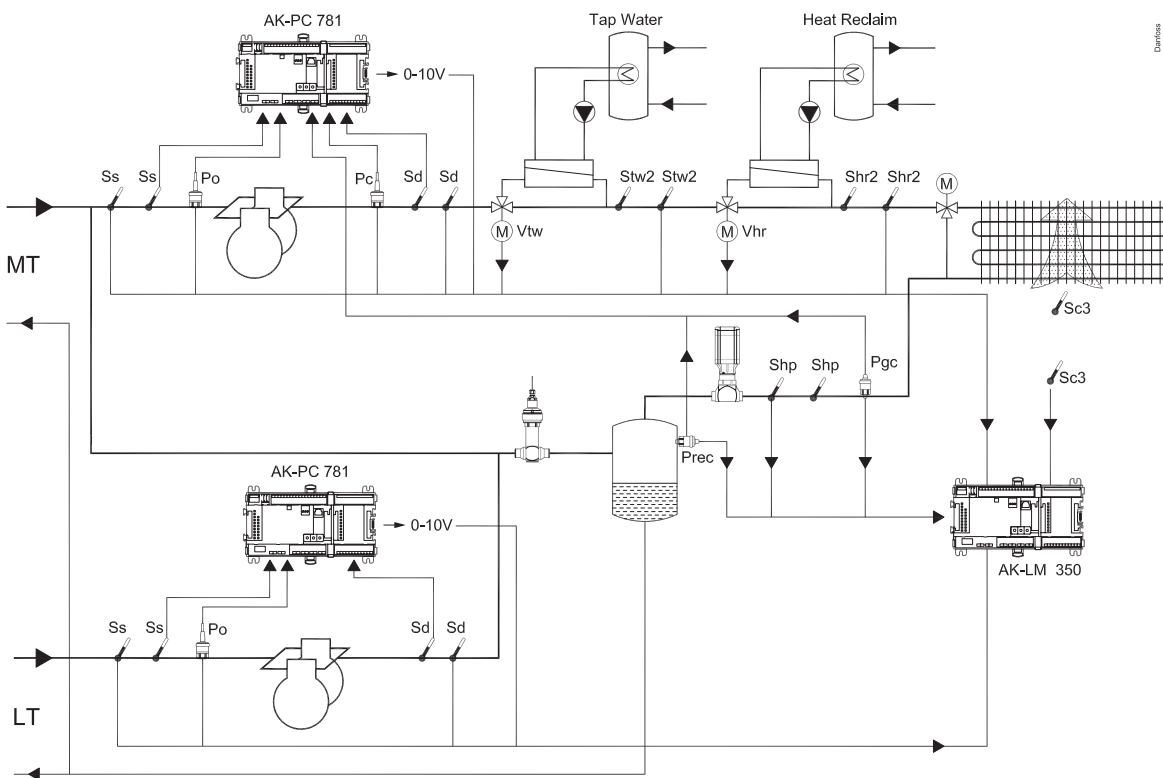

Danfoss
0282645_10

Cascade

Example requires:
 S = 9 pcs.
 P = 3 pcs.
 DI = 2 pcs.
 U = 2 pcs.

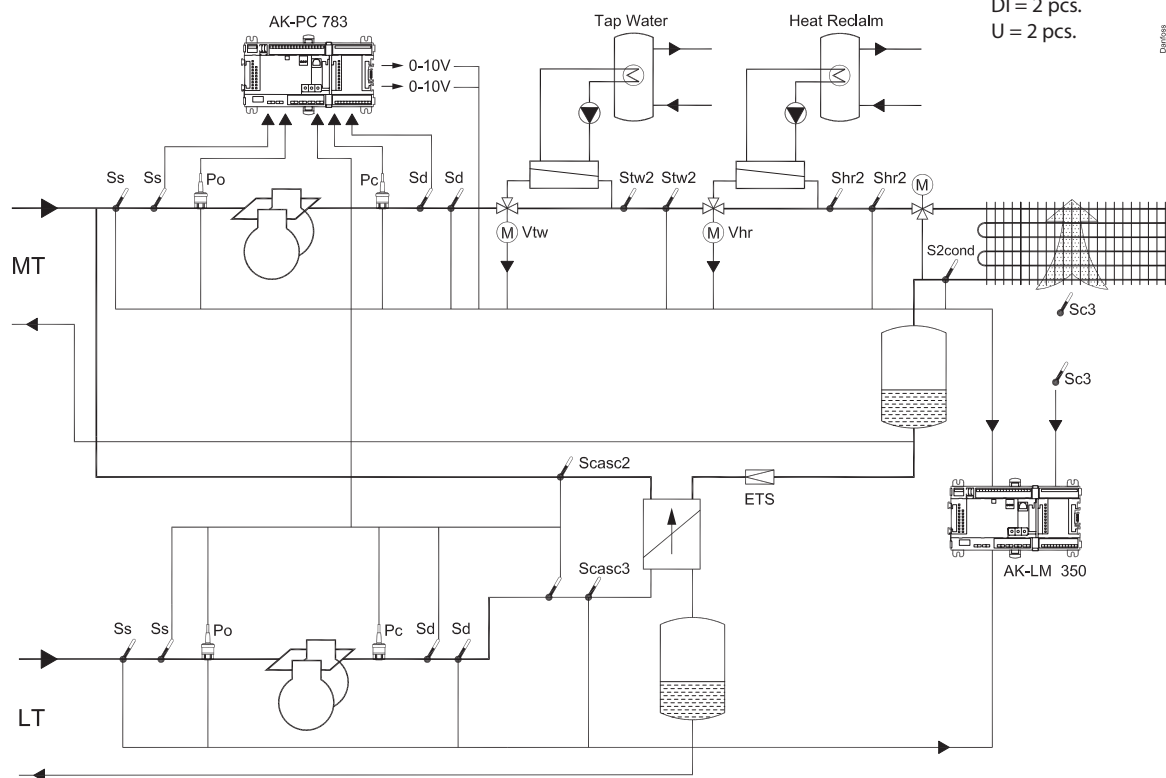

Danfoss
R002952.10

Single stage

Example requires:
 S = 4 pcs.
 P = 2 pcs.
 DI = 0 pcs.
 U = 1 pcs.

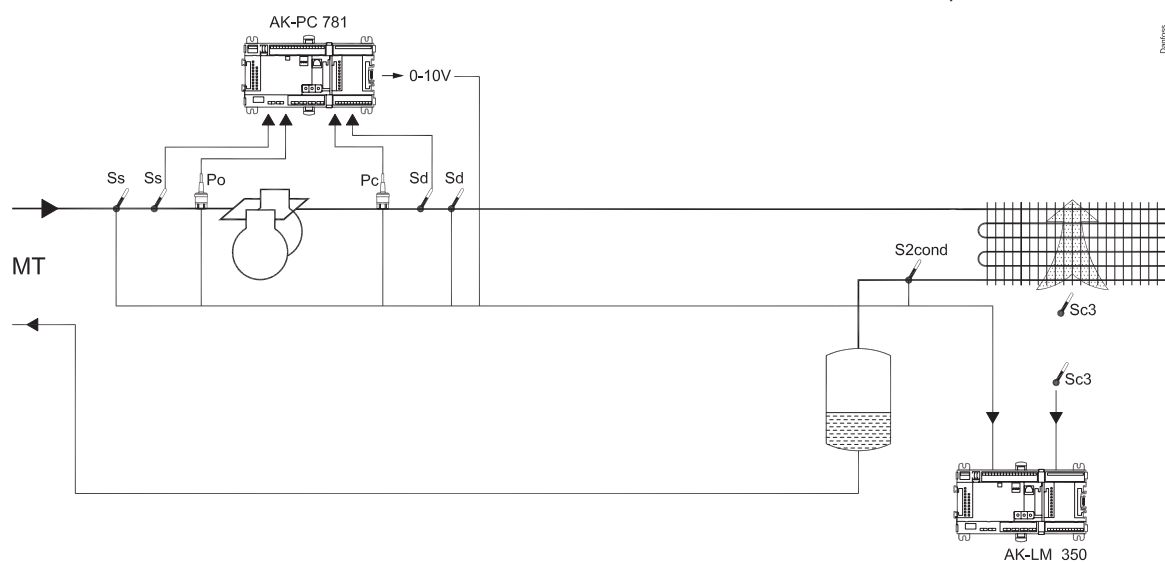

Danfoss
R002952.10

