

## Data sheets

For standard refrigerants > Standard series

Technical data:		
Cylinders	#	4
Displacement @ 50 Hz	m <sup>3</sup> /h [50Hz]	24.7
Displacement @ 60 Hz	m <sup>3</sup> /h [60Hz]	29.6
Motor version[1]		2
Nominal Motor power	HP	4
Nominal Motor power	kW	3
Motor voltage at 50 Hz[2]	V/ph/Hz	220-240V - 380-420V/3/50Hz DOL
Motor voltage at 60 Hz[2]	V/ph/Hz	265-290V - 440-480V/3/60Hz DOL
CC Head capacity control steps	%	100-50
RSH Head capacity control steps	%	100-75-50
MRA, max operating current at 230V/50Hz and 280V/60Hz	A	19.1
MRA, max operating current at 400V/50Hz and 460V/60Hz	A	11
LRA, max starting current at 230V/50Hz and 280V/60Hz, DOL motor	A	92.6
Frequency min	Hz	25
Frequency max[3]	Hz	87
Electric terminal box class protection		IP56
Maximum pressure HP	bar	30
Maximum pressure LP	bar	20.5
Oil type[4]		POE32
Oil charge (3/4 of sight glass)	l	1.6
Lubrication type		Centrifugal
Suction valve (SV)	inch	1 1/8
Discharge valve (DV)	inch	3/4
Net weight	kg	77
Max Length	mm	449
Max Width	mm	286
Max Height	mm	325
Rubber mounts diameter	mm	40
Rubber mounts height	mm	40
Rubber mounts shore	sh	45
Sound power level (-10/45, R404A)[5]	dB(A)	70
Sound pressure level @ 1m (-10/45, R404A)[5]	dB(A)	62
Compressor body material		Ghisa GJL250
Motor protection		AMS
Oil level sight glass	#	2
LRA, max starting current at 400V/50Hz and 460V/60Hz, DOL motor	A	53.2
Control and protection device		INT69®

- [1] Motor version: 1 = high and mid temp. all refrigerants; 2 = low and mid temp. all refrigerants; 3 = ECOinside, low temp. R134a, R1234ze, R1234yf only
- [2] Other motor voltage available on request
- [3] Maximum frequency depends on the working conditions: use the FSS.3 (Frascold selection software)
- [4] For alternative lubricants refer to bulletin FTEC022
- [5] Sound pressure in free field, hemispherical model at 1 meter distance, 50Hz; PWL and SPL in different conditions are available on

## Data sheets

For standard refrigerants > Standard series

Accessories:	
Water cooled head	T00SK50020
Oil heater (230V-70W)	T00CH1-RIC
Discharge temperature sensor	T00EC50D
RSH capacity control head 230V AC	T00SK220310
CC capacity control head 230V AC	T00SK220150
US unloader start head 230V AC	T00SK250150
Head cooling fan - 230V/1/50-60Hz	SZ-FM9
Electronic oil level regulator - INT280 Diagnose 230V AC	T00EC1900
Kit adapters for oil equalization line - 1" ROT 5/8" ODS	T00SK170200
Kit adapters for oil equalization line - 1"1/4 ROT 1"1/8 ODS	T00SK170300
DP Modbus Gateway	T00EC59
Connection cable Modbus Gateway - INT69	T00EC64
USB adapter cable	T00EC57

## Data sheets

For standard refrigerants > Standard series

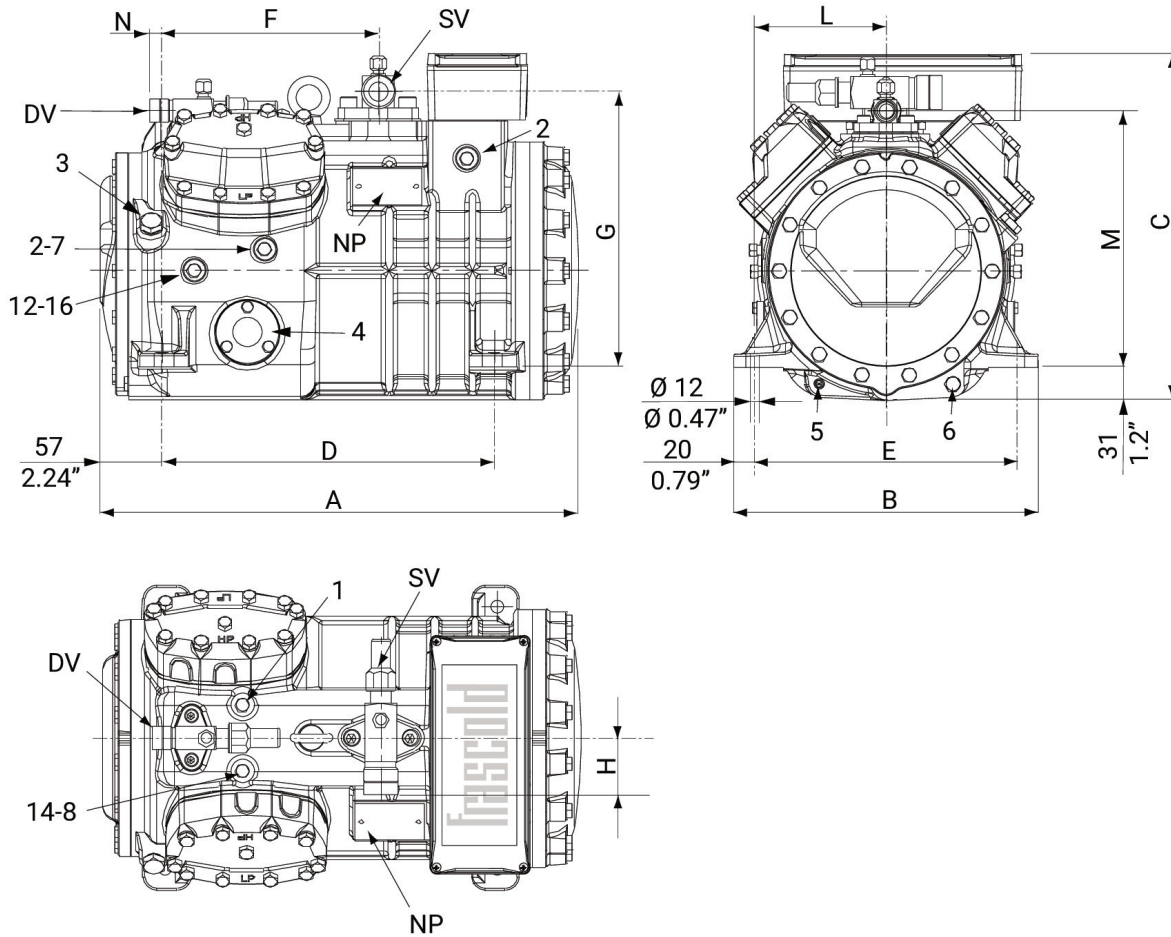

### Dimensional drawing:

SV Suction valve (SV)	mm	28.6
DV Discharge valve (DV)	mm	19
SV Suction valve (SV)	inch	1 1/8
DV Discharge valve (DV)	inch	3/4
A Length (A)	mm	449
B Width (B)	mm	286
C Height (C)	mm	325
D Base mounting (D)	mm	312
E Base mounting (E)	mm	246
F Suction valve (F)	mm	203
G Suction valve (G)	mm	258
H Suction valve (H)	mm	53
L Discharge valve (L)	mm	123
M Discharge valve (M)	mm	239
N Discharge valve (N)	mm	17
1 High pressure plug (1)		1/8" NPT

2 Low pressure plug (2)		1/8" NPT
3 Oil charge plug (3)		1/4" GAS
4 Oil level sight glass (4)		-
5 Crankcase heater (5)		-
6 Oil drain plug (6)		M8 x 22
7 Liquid injection valve plug (7)		1/8" NPT
8 Liquid injection sensor plug (8)		1/8" NPT
12 Oil return plug (12)		1/8" NPT
14 Max. discharge temperature sensor (14)		1/8" NPT
16 Crankcase pressure plug (16)		1/8" NPT
NP Name Plate (NP)		-