

ENGINEERING
TOMORROW



User Guide v2.x

AK-System Manager

AK-SM 800 Series

ADAP-KOOL® Refrigeration Control System



Contents

Document History	3
Product Introduction	4
Ordering	5
Specifications	5
Installation	6
Connections	8
Network topology	8
RS 485	9
Modbus	10
First time startup	11
AK-SM 800 Host Network Configuration	11
Remote Management Tool (RMT)	13
Initial Configuration - language	16
System Upload / Download	17
Initial Configuration - Web Wizard	18
Copy Wizard	21
Configuration	22
Service Tool Support	40
Master Control Functions	41
Rail Heat	41
Schedules	44
Schedules manual override	46
Suction Pressure Optimization	47
AKC ON (Evap shutdown when injection off)	49
Danfoss AKC Support (Via AK-PI 200)	51
Miscellaneous Configuration	56
Managers Override	63
Lighting Configuration	64
Dimming control via AK I/O	67
HVAC Configuration	70
CoreSense™ (Modbus) Support	75
Energy Measurement / Load shed	76
Coordinated Adaptive Defrost	80
Boolean Logic / Calculations	85
Energy Configuration	87
Detail -> Energy	91
Enterprise Load Shed (via Danfoss EDS Service)	92
Demand Limiting	93
General navigation, operation and use (via web)	94
Connecting to your AK-SM:	94
Dashboard view:	94
File	95
Managing alarms:	100
Device detail:	101
System view:	102
Schedule view:	103
History (Logs)	104
Collecting and viewing history	105
Recommended method for upgrading your AK-SM 800 series front end	106
Device Management	108
(Configuration/System/Device Management)	108
AK-SM 800 Device support guidelines	109
Glossary of terms	110

Document History

Document revision

Document	Notes
USCO.PI.R1.E1.02	First document release
USCO.PI.R1.E2.02	Updated document for copy wizard, PI-200 AKC support
USCO.PI.R1.E3.02	Updated document for history and alarms export Updated doc for history and alarms export feature in StoreView Desktop Updated doc for new internal alarm relay option Updated document to cover software V08_02x
USCO.PI.R1.E4.02	Updated the following sections: Communication Configuration, Updating Software
USCO.PI.R1.E5.02	General document update
USCO.PI.R1.E6.02	General document update
USCO.PI.R1.E7.02	Updated the following sections: CoreSense™ (Modbus) Support, Energy Measurement / Load shed, Coordinated Adaptive Defrost

Product Introduction

Your Application

The Danfoss AK-System Manager (AK-SM) is a modern solution for the food retail markets. The AK-SM uses the latest technology to provide the maximum benefit to the end user, both in terms of energy saving optimization, control options and user friendly access. Designed specifically with the food retail applications in mind, the AK-SM provides all the functionality and tools to provide full application 'coverage', for the Refrigeration control and monitoring application.

The Danfoss AK-SM represents the most flexible answer to today's demands & balances cost effective control, continuous energy optimization and long term flexibility via miscellaneous inputs and boolean logic commands, all built in to one easy to use front end controller.

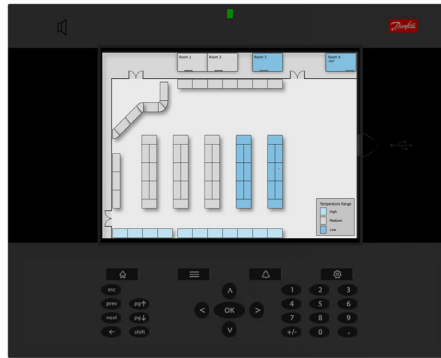

Modern Technology at work for you

Modern tools like the built-in USB flash drive port allows for easy firmware updating & saving of the database. All part of the AK-SM package is the Remote Management Tool, a simple yet powerful application that allows remote updates, software management and the saving of databases on the AK-SM. Full remote access is powered by the AK-SM built in web server, providing you with an advanced web browser environment in which to control, view & monitor all your important assets.

AK-SM Headline Features <i>*License dependent</i>	Benefits
Refrigeration Control (centralized and de-centralized methods)	Control and monitor your Refrigeration application via centralized (Rack) or de-centralized (Case/Pack) dependent on your control needs.
Energy saving technology (built in)	Master control, Suction optimization, scheduling, enterprise load shed
Schedules Groups	Central Defrost, Case lighting, Store / Outside Lighting, Night setback, Shutdown
Flexible Alarm Routing / Output	e-mail, IP address, relay
Built in Modbus, LonWorks® network	More scope for control solutions - Established protocols
Full color VGA Local screen view & access	Access all areas of your system from easy to use local screen
Built in Buzzer & 2-tone LED	Easy local level alarm notification
Support for Danfoss AK I/O modules	I/O module support offering extended and flexible control, monitoring
Local screen custom graphics	Create simple & clear graphic screen with only 'key parameters' shown - simply the management of your services. Max.5 BMP's max. 100 log points each
Consolidated store view	Show a consolidated web view of your store, not just individual AK-SM controllers. View all data from all interconnected AK-SM devices in common web browser pages
600 History points	Large history storage capacity to ensure HACCP compliance & service level detail
Web browser custom graphics	Create custom web graphics that present in the AK-SM web screens. Map any datapoint from any AK-SM controller and visualize in the web. Max.5 JPG's max. 200 log points each
Multiple users / user levels	Definable user list with clear authorization levels
Multiple language support	Local & Browser language support
USB flash drive support (load,save and update software)	Reduce commissioning time & Cost
Full web browser access	Standard web browser connection provides access to all areas of the system
Built in Boolean Logic commands	Create your own logic to control even the most obscure application
Remote Management Tool	Remotely manage your system - Update software, save database, controller file management, load images, allowing custom image & mapping of parameters
Service Tool support	Gain access to Danfoss AK2 based controls via Service Tool tunneling
HVAC Control	AK SM 820 and AK-SM 880 offer HVAC support
Lighting Control	All systems support Lighting Control

Ordering

Contact your local Danfoss sales office

Ordering	Description / License type	Format
Device Platform - RS485 LonWorks®		
080Z4004	AK-SM 820 Control RS485-Screen / Convenience store	Lon RS485 Screen
080Z4001	AK-SM 850 Control RS485-Screen/ Refrigeration license	Lon RS485 Screen
080Z4008	AK-SM 880 Control RS485-Screen / Full store	Lon RS485 Screen
080Z4009	AK-SM 880 Control TP78 retro-fit – screen / Full store	Lon TP78

Specifications

The mounting location should be flat, dry and free of major vibrations. The AK-SM 800 should be mounted at eye level.

Environmental Range:

Operating temperature:
-10 to +55°C (14 to 131°F)
@ 90% RH (non condensing)

IP20

Electrical range:

~ 100 - 240 V a.c. 50/60 Hz

Built in alarm relay,

Contact voltage: Up to 240V, Load: AC-1 (Ohmic) Current rating.

5 Amp AC-15(inductive) Current rating. 3 Amp

LCD

Active TFT colours (thin-film transistor), SVGA 800 x 600

Size

Unit Width 295 mm (11.6"), Unit Height 235 mm (9.3"),

Unit Depth 65 mm (2.5")

Mounting holes 246 mm (9.7") Width

Mounting holes 175 mm (6.9") Height

Approvals:



Declaration of conformity info

- Regulation 2005/37/EC
- EN 12830, 07-1999
- EN 13485, 11-2001
- HACCP 080R1215
- CE 080R1213
- C-Tick 080R1214
- UL E31024

Capacitive load

The relays cannot be used for the direct connection of capacitive loads such as LEDs and on/off control of EC motors.

All loads with a switch mode power supply must be connected with a suitable contactor or similar.

USB Access door

Active USB Flash drive (use for load/save database and AK-SM software) User Authorization required'

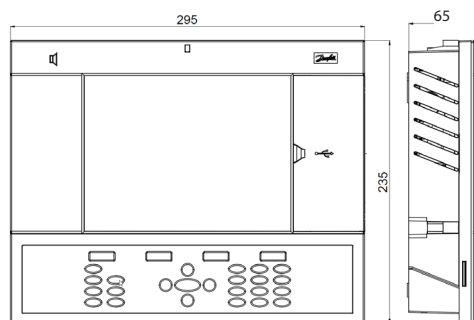
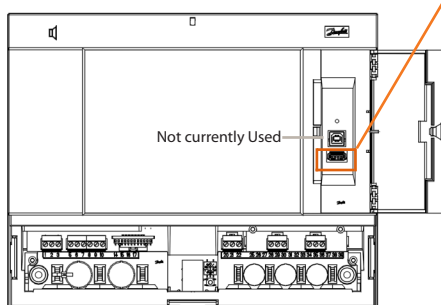

High voltage

WARNING: To avoid risk of injury from electric shock, ensure correct electrical isolation is made before working within the enclosure.

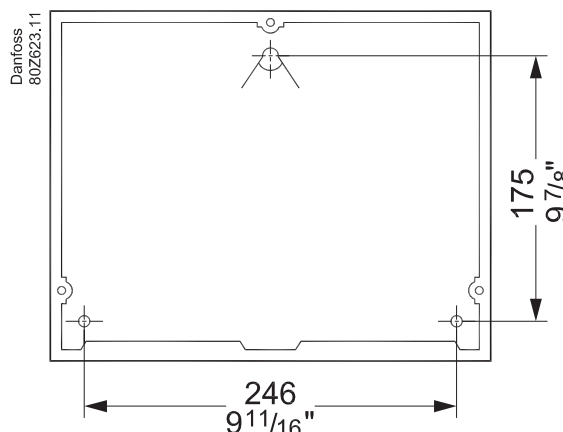

Installation

Tools needed

- Bubble level
- Small slotted screwdriver for connector screws
- Torx 8 screwdriver for releasing the electronic unit and for fastening the unit when recessed mounted
- Screwdriver for fixating the AK-SM 800
- Pen for marking the 2 lower fixation holes
- Larger slotted screwdriver for releasing the Technician lid

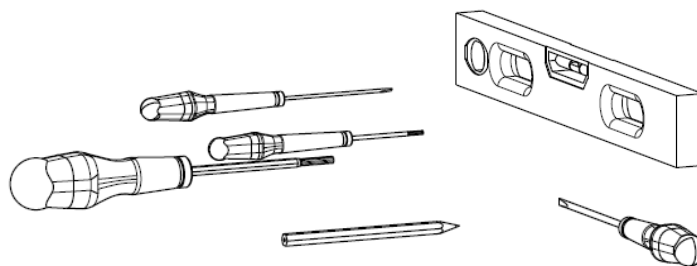

Wall Mounting- box

- Attach screw to the wall
- Mount AK-SM 800 to the screw
- Loosen Technician lid (three sides)
- Remove Technician lid
- Level the AK-SM 800
- If drilling is necessary, mark up 2 screws in Connector part.
- Attach the Connector part to the wall using another 2 screws

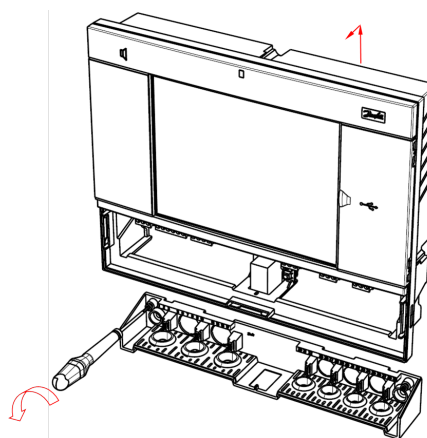
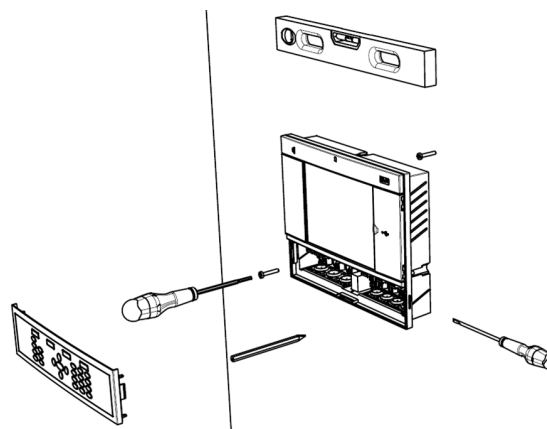

Wall Mounting- wiring

- Insert cables through the rubber grommets

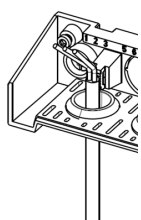
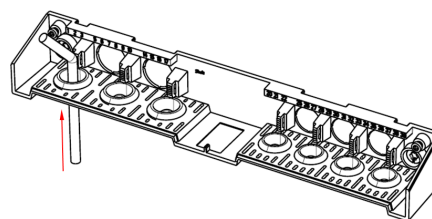

Strip the cables

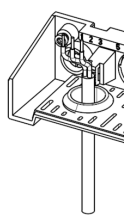

Strip the wires

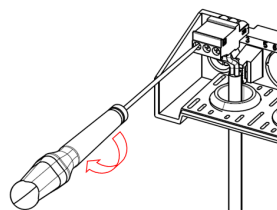

Secure wires in connectors by screwdriver

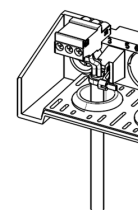

Strain relief the cables

Carefully replace the keypad, ensure that it securely snaps into place

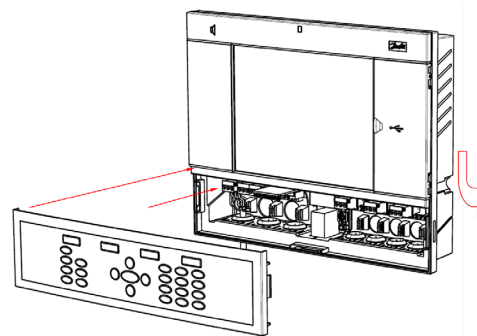

Wall Mounting- Panel recessed

From the front:

A hole of the size 280 x 220mm is machined

The AK-SM 800 is inserted in the hole

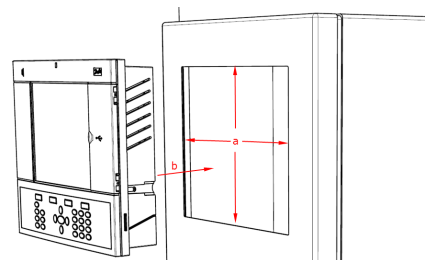

From the backside:

Slide the 3 fastener into the housing part

The screws are inserted into the fasteners

Secure the unit by tightening the screws

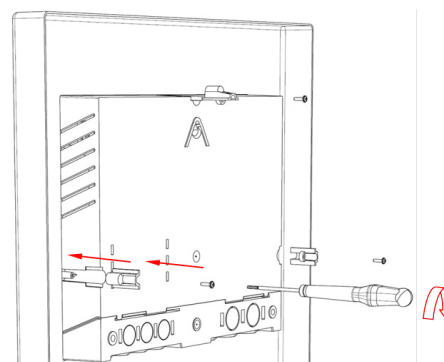

Remove Technician lid

From the back, push cables inside the housing

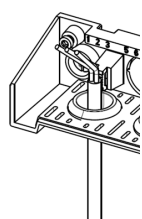
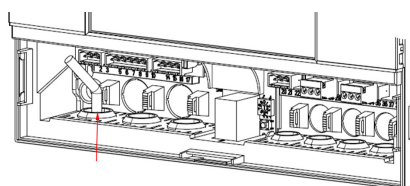

Strip the cables

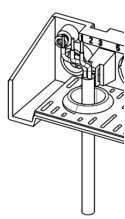

Strip the wires

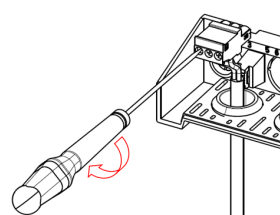

Secure wires in connectors by screwdriver

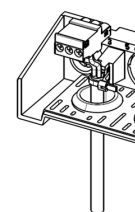

Strain relief the cables

Carefully replace the keypad, ensure that it securely snaps into place

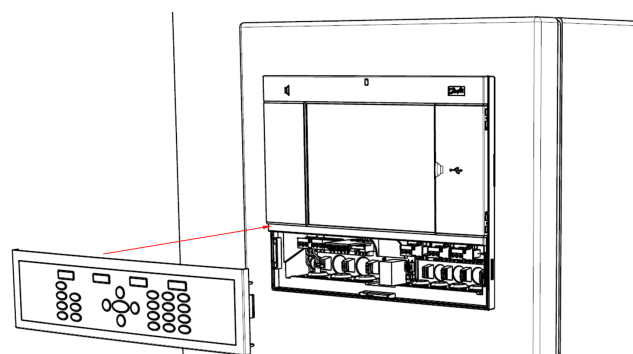

Connections

The following chapter describes the available connections on your AK-SM 800.

Please note that not all connection points are currently active, please refer to the drawing below for more details

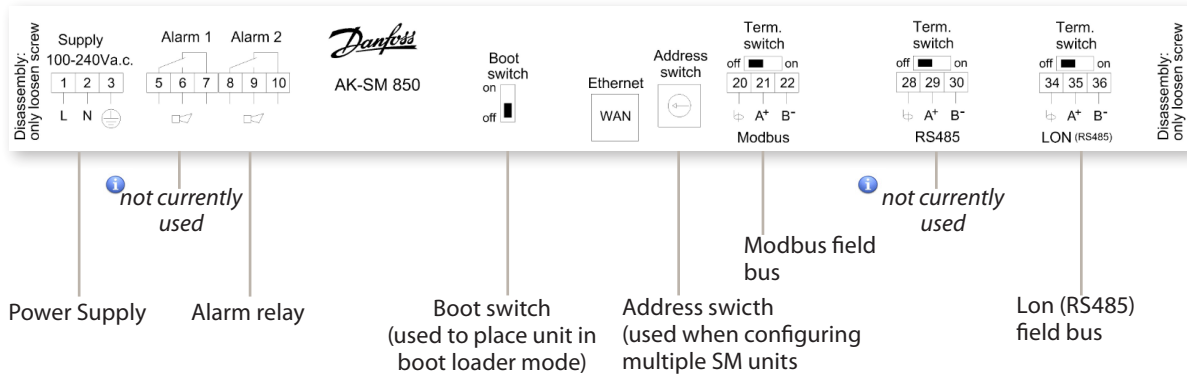

RJ 45 LAN, Use shielded Ethernet cable

Network topology

Your AK-SM supports both Modbus and Lon RS485 local bus connections. For further detailed description of network connections please refer to document 'Data Communication between ADAP-KOOL® Refrigeration controllers_RC8AC602'

Lon RS485

Follow standard topology guidelines for Lon RS485, with particular respect to maximum cable length, when to use a repeater and ensuring suitable resistors are in place.

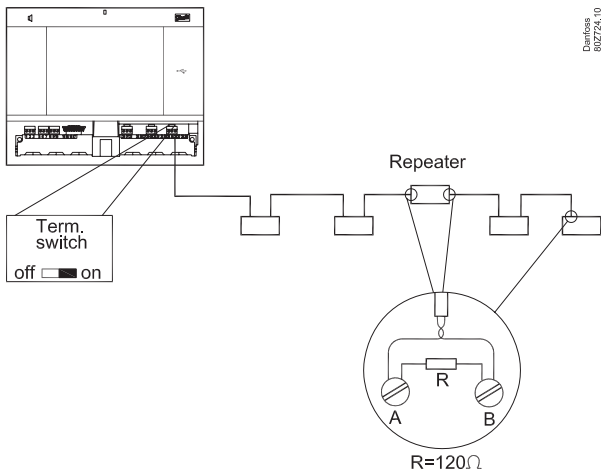

When using the Lon RS485 network, ensure the Term. Switch on the AK-SM is in the 'ON' position (enable internal resistor). Any repeaters must also have 120 Ohm resistor in place. Finally, ensure that the last controller on the network run also has its end of line on line resistor enabled.

Cable type

Cables twisted in pairs must be used, and they may be provided with a screen. Some types of communication require a cable with a screen to be used. The conductor's cross section must be at least 0.60 mm. Examples of cable types:

- Belden 7701NH, single-thread 1 x 2 x 0.65 mm, without screen
- Belden 7702NH, single-thread 2 x 2 x 0.65 mm, without screen
- Belden 7703NH, single-thread 1 x 2 x 0.65 mm, with screen
- Belden 7704NH, single-thread 2 x 2 x 0.65 mm, with screen
- LAPP UNITRONIC Li2YCY (TP), multi-thread 2 x 2 x 0.65 mm, with screen
- Dätwyler Uninet 3002 4P, single-thread 4 x 2 x 0.6 mm, with screen

Cable length

A cable length must not exceed 1200 m (4000 foot). A repeater (Part # 084B2241) must be used for longer lengths.

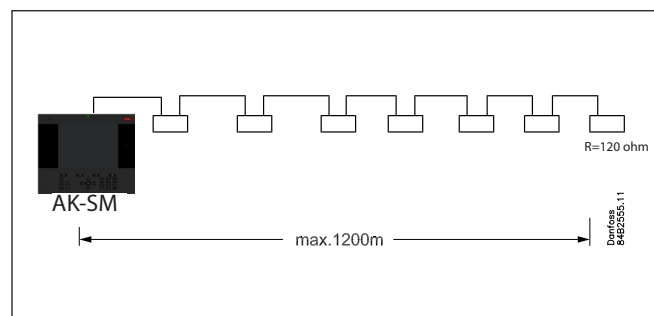

Lon RS485 Topology

The cable connection must be connected from controller to controller, and no branches are allowed on the cable. If the cable length exceeds 1200 m a repeater must be inserted. If the data communication cable runs through an electrically noisy environment which impairs the data signal, one or more repeaters must be added to stabilise the signal.



When configuring Lon devices on the control bus, the highest device address that can be used is 127 (max. 120 controller in total)

Remember to use 120Ohm terminators on the last filed bus controller device. Note also to enable (ON) the Term. Switch, located above each network connection point on the AK-SM 800, this will enable the built in terminator(s) for each network point on the AK-SM 800.

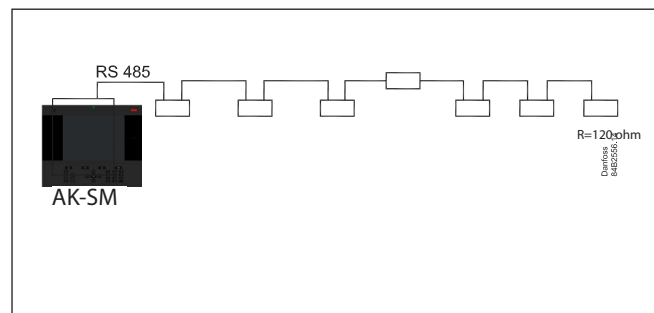

Conductors

The two wires are looped from device to device. There are no polarisation requirements. (On some controllers, the clamps are designated A and B. On others there is no designation. Otherwise the connections are identical.) If a screen is used, it must be connected to the system device and any repeaters. A screen must always be looped from device to device.

The screen must not be connected to anything else.

(The screen is earthed inside the screen and must not be earthed in any other way.)

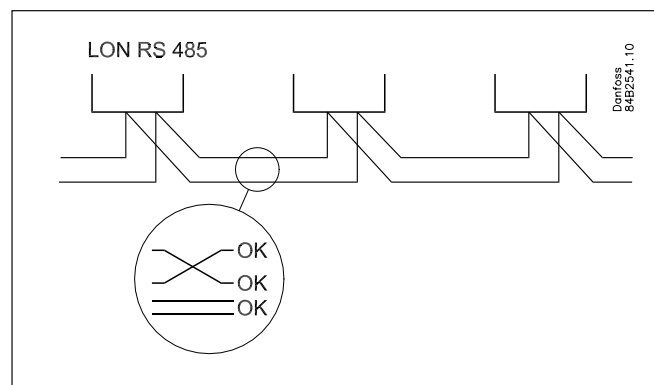

Mid network connection.

This example shows the AK-SM 800 series RS485 version used in the middle of a network run. In this example ensure that both ends of the controller run are fitted with 120 Ohm terminators.

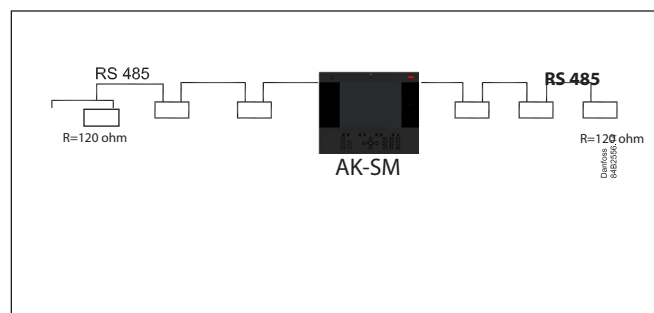

Over the past several years Danfoss has offered a version of the AK-SC 255 and AK-SC 355 which has a LonWorks® option of TP78. As a physical layer of the LonWorks® protocol these older systems offered x5 network connection points. Due to the global phase out of the TP78 option by the OEM, Danfoss has made available a special order version of the AK-SM 880 (080Z4009), which will come pre-installed with a LonWorks® TP78 options card. This 'special' version of the AK-SM 880 is designed to support customers who wish to migrate from existing AK-SC 255 and AK-SC 355 TP78 systems. Please note that this version of the AK-SM 880 is not intended or available in Europe', and offers x4 TP 78 connection points.

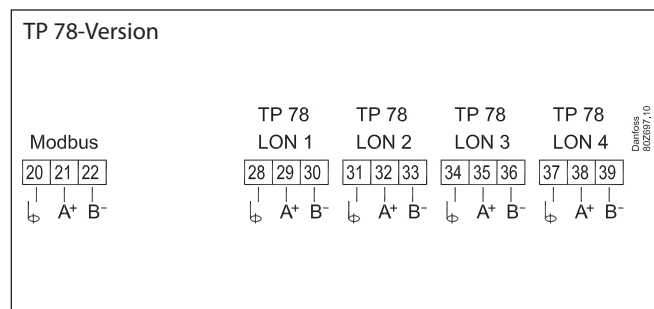

Modbus topology

The cable must be with screen. The cable is connected from controller to controller, and no branches are allowed on the cable. If the cable length exceeds 1200 m a repeater must be inserted. One repeater must be added for every 32 controllers. If the data communication cable runs through an electrically noisy environment which impairs the data signal, one or more repeaters must be added to stabilise the signal.



When configuring Modbus devices on the control bus, the highest device address that can be used is 199 (max. 120 controller in total)

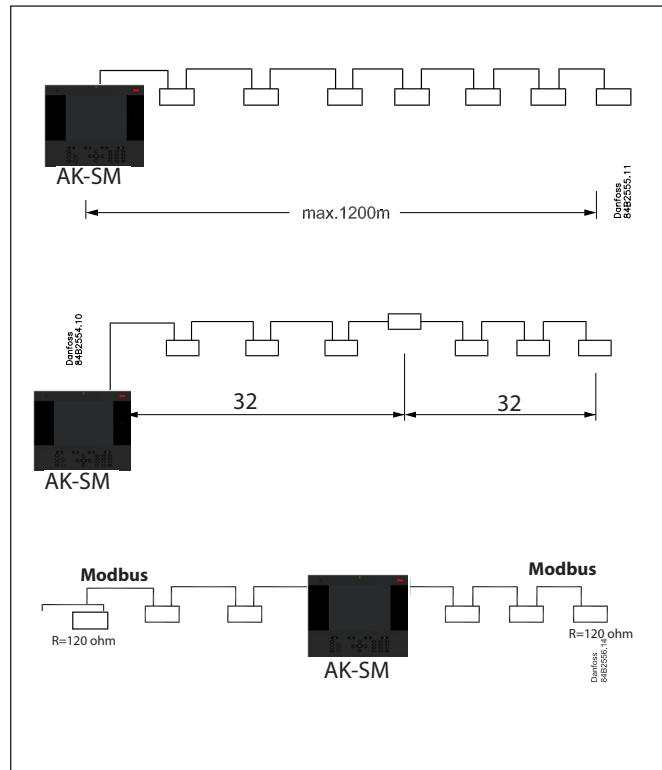

The wires are looped from device to device.

A is connected to A

B is connected to B.

The screen must be connected to the system device, all controller and any repeaters.

A screen must always be looped from device to device.

The screen must not be connected to anything else.

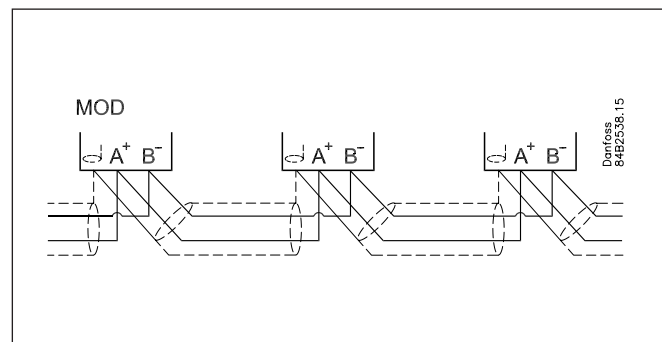

Be sure to configure the Modbus repeater AKA 222

(code#084B2240) to the correct baud rate.

See notes section at the back of this guide for Modbus device baud rate properties.

Refer to Danfoss Instructions RI8KN402 for further details on the AKA 222 repeater'

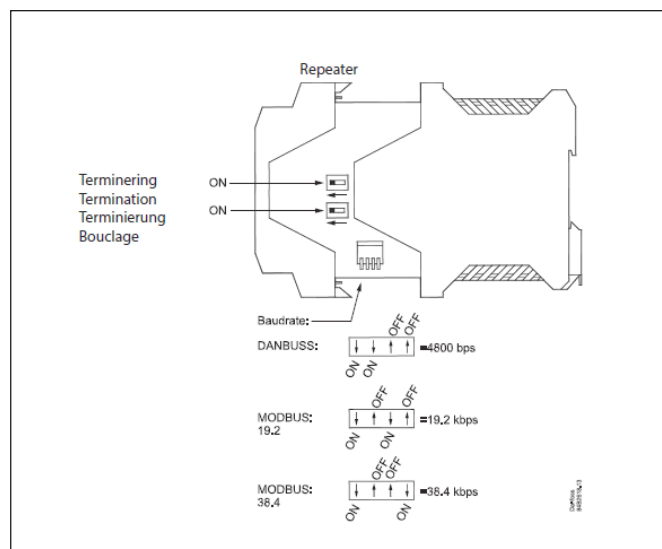

First time startup

A new feature in 08.045 is initiated when installing and powering up your AK-SM 800 series for the first time, a wizard style guide will appear on the local screen. The idea of this initial settings wizard is to allow the Commissioning user to configure the basic parameters required for setup. Note that once a AK-SM 800 series database field has been set, the initial settings wizard will no longer be displayed, the work-flow is only designed to run once on new systems.

The following screens will be presented in the initial settings wizard;

LANGUAGE (this selection will also set the system units of measurement)
 DATE/TIME
 PREFERENCES
 USERS/PASSWORDS
 COMM

After completion of the settings wizard the AK-SM 800 Series will request a reset, where settings will be saved. Commissioning activities can now continue using Web wizards and control screens

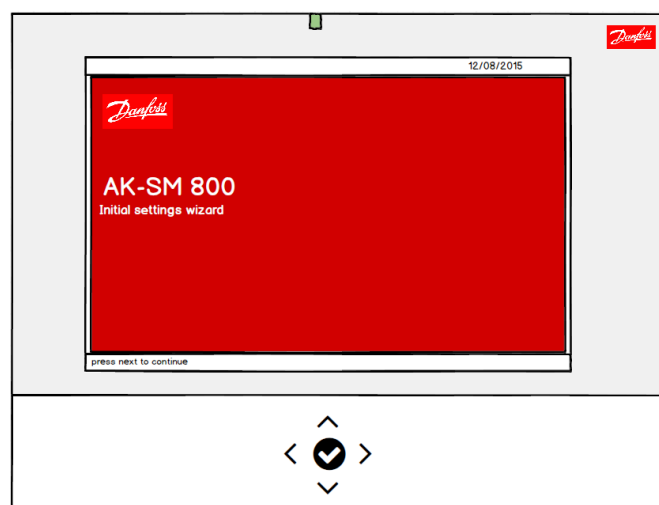

AK-SM 800 Host Network Configuration

The following section describes how to configure your AK-SM 800 to facilitate a host network. The AK-SM 800 host network can support up to a max of 10 interconnected AK-SM800 units. The practice of interconnecting on a host network allows for support of larger applications or to separate discrete control applications onto dedicated AK-SM 800 units. For example HVAC and Refrigeration control could be done via dedicated AK-SM 800 units. The host network requires an IP Ethernet connection to each AK-SM 800 unit. Once configured all AK-SM 800 units can be viewed in a consolidated format via a web browser or via the StoreView Desktop. Note that the consolidation view is only available via the browser or StoreView desktop, not local screens.

Master device configuration

Make sure you have suitable fixed IP or DHCP addresses for each of your AK-SM 800 units you wish to deploy on the host network. Also ensure all Ethernet cables are connected.

Make sure the rotary address switch (located behind keypad) is set to 0. Zero defines your AK-SM 800 as the master node on the host network.

Navigate to the Configuration/Comm screen and check your unit has a valid Master IP address. Set the 'Host Network' question to Enabled. Enter the number of System Manager units you intend to have on the host network.

After all changes are complete reset the master AK-SM 800 unit

Location: Configuration

Wizards	Time	System	Comm	Alarms	Control	Network Nodes	History
Press to reset this unit							
Internet							Yes
NOTE: Reset unit after making changes!							
Use DNS							No
Use DHCP							Yes
Use IP address as backup							
if DHCP fails							No
Master IP Address							10.38.25.64
Host Network							Enabled
SM850's on network							1
Node to be used as							Master
No of Ext. Internet							1
Internet IP Address 1							
Web Server Port							80
FTP Server Port							21
FTP Data Port							20
Network timing support							No

Slave device configuration

Make sure the rotary address switch (located behind keypad) is set to the appropriate number. For example, setting the switch to 1, will define the unit as a slave device address 1. All units in the host network must have unique host network addresses (address 0 is always master).

Once you have set the rotary address switch, reset the unit and allow the AK-SM 800 to boot up. Navigate to the Configuration/Comm screen and check your unit shows the Master IP address. Set the 'Host Network' question to Enabled. Enter the number of System Manager units you intend to have on the host network (matching what you have already set in the master unit)

Make sure the slave unit has a valid IP address.

Location: [Configuration](#)

Wizards	Time	System	Comm	Alarms	Control	Network Nodes	History
Press to reset this unit							
Internet							Yes
NOTE: Reset unit after making changes!							
Use DNS							No
Use DHCP							Yes
Use IP address as backup							
if DHCP fails							No
Master IP Address							10.38.25.64
Host Network							Enabled
SM850's on network							1
Node to be used as							Slave
Slave IP Address							10.38.25.64
No of Ext. Internet							1
Internet IP Address 1							
Web Server Port							80
FTP Server Port							21
FTP Data Port							20
Network timing support							No

To validate the host network has been correctly configured and all System Managers can see each other refer to the Master unit 'info' screen. Here you should see all AK-SM 800 on the host network

File	Dashboard	Alarms	System View	Detail	Schedules	Info	
Information							
Unit	Calculations	Internet	Messages	Contacts	Audit Trail		
Mac Address							00:0B:2D:03:16:4D
Unit Address							0
Using DNS							No
Using DHCP							Yes
Default Gateway							10.38.25.1
Network Mask							255.255.255.0
IP Address							10.38.25.64
Host Network							Enabled
Node to be used as							Master
SM850's on network							1 (of 1)
Addr 0: 10.38.25.64 (Online)							

Remote Management Tool (RMT)

The Remote Management Tool (RMT) is a PC software application tool that is designed to support the AK-SM, both in commissioning and service. The RMT is a powerful tool that allows full offline programming and simulation of AK-SM databases, providing the opportunity to save considerable on site commissioning times. In addition, the RMT tool has various remote management features, facilitating complete system management. Creating custom images for the AK-SM web browser is also another function of the RMT tool. The following features can be seen in the RMT;

- **Offline web Programming**
Launch offline web simulator(s) to allow full offline AK-SM database programming, with controller simulation you can fully pre-program your application and save the resulting database to USB for on site install.
- **Program simulation**
From within the web browser session simulate board and point variables to test calculations and system behaviour
- **Custom Graphics**
Use your own Jpeg or bmp file to create custom images, mapped with any configured system datapoint
- **FTP (File Transfer Protocol)**
Remotely connect, load and access system files (html web & EDF device files) Retrieve datapoints
- **Address Book**
Save your most commonly connected site details to allow for one click connection
- **Tools**
Download System software, backup (save) & load database files.
- **Language**
Compatible in multi- languages

The RMT tool is available from your Danfoss sales office with associated supporting documentation.



IP Configuration and suggested security settings

The Configuration->Comm screen allows important routing and IP configuration to be set. With correct settings you will be able to remotely connect to your AK-SM 800 series controller. Note that after making any changes in this screen a system re-set is required to save settings.

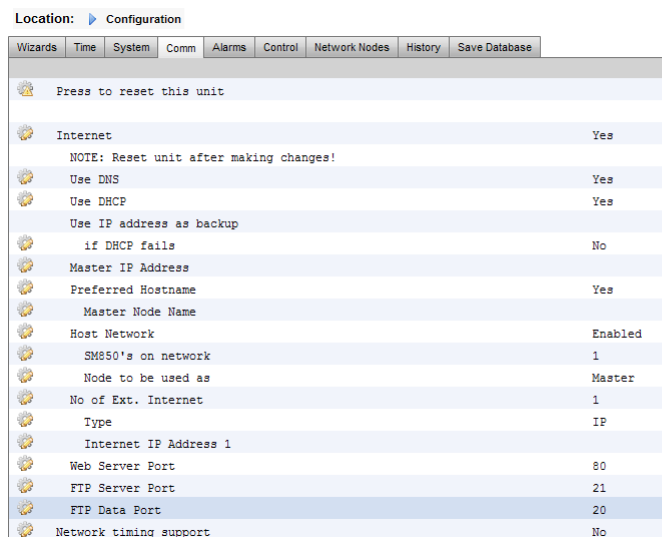

Use DNS (Yes/No)

Domain Name System- select to YES to enable this feature and take advantage of your networks naming service. When answering YES (and with DHCP set to NO), the preferred host name line appears together with Domain Server IP address. There are two lines for the domain server IP or DNS name. Note that if DHCP is set to yes, the domain server IP address lines are not visible.

Use DHCP (Yes/No)

Dynamic Host Configuration Protocol (DHCP) is a standard network protocol that dynamically distributes network configuration parameters, such as IP addresses. If you connect the AK-SM 800 controller to a valid DHCP server the controller will obtain an address automatically. The management (renewal, binding and lease) of the IP address is fully automatic. It is strongly recommended that DNS is used in conjunction with DHCP so to keep track of dynamic addressing.

Use IP address as backup if DHCP fails (Yes/No)

If a non-reliable DHCP service is suspected, you can insert a fixed IP address that will be used in the event of a DHCP failure. Under normal network conditions this feature would not normally be required.

Master IP address

Your AK-SM 800 series controller is a so called 'master' when the rotary address switch (located behind keyboard cover) is set to 0. This automatically assigns the unit as a master and is used when operating with multiple AK-SM 800 units (host network)

Preferred Hostname

If DNS is set to YES then a preferred hostname line appears. Selecting YES to the preferred hostname will enable Master node name line (see below). If DNS is set to No, the site name and unit name (site name-unit name) will be used by default. Note: Site Name and Unit name should be configured under the Configuration->System screen.

Master node name

Enter a name here, used to identify the AK-SM 800 controller on the router.

Host Network (Enabled / Disabled)

If your AK-SM 800 will be part of an interconnected host network of AK-SM 800 units, select 'Enabled' to this question. If there is only 1 AK-SM 800 controller then leave set as Disabled.

SM800 on network (1-10) – enter how many units will be on host network

Node to be used as (Master / Slave) – Select 'Slave' for all units with rotary address switch set to 1 or above

No of external Internet (1-3)

If your AK-SM 800 series controller will be made accessible from an external location (outside of LAN/Internet), then this feature needs to be enabled with at least 1 external internet ID. Once at least 1 external internet line is added the type (see below) can be entered. The use of the external internet configuration is to ensure remote web browsers or Store View Desktop can access your AK-SM 800 from outside of the local area network.

Type (IP/ Name) – This is a new feature added in software version V08_027 and higher. Select IP for static addressing or Name if using DHCP

Internet IP / Name address – Enter IP or Name (based on above selection)

Web server port (user configurable)

Used to allow HTTP traffic / support browser access to your AK-SM 800 controller. **Danfoss strongly recommends changing the factory default to something other than port 80 if used outside of LAN network or exposing to the Internet. For example, change web server port to 5080**

IP Port	Use	Notes
80	web browser	This port is user configurable but factory set to 80
20 & 21	RMT tool	This port is user configurable
25	e-mail	e-mail output
3001	XML	Used for XML communications
1041	Service tool (ST500 ver. 3.29d and higher)	used for tunneling through SM800 series to AK2 controller

FTP Server port (user configurable)

The AK-SM 800 series controller uses 'Active' FTP. Used to transfer database and EDF files. **Danfoss strongly recommends changing the factory default to something other than port 21**

FTP Data port (user configurable)

The port used to support file transfer

Network timing support (NTP)

Use this function (if supported by your network) to sync the AK-SM 800 real time clock over the network, known as NTP. Requires NTP sever address and Time Zone offset to be programed.

Note: Time Zone offset can be configured under the Configuration->Time screen

General IT security / Recommendations

The AK-SM 800 series device is an embedded controller designed to be installed behind an appropriate router and firewall. The AK-SM 800 itself does not offer routing or firewall options, additional security steps must be taken to secure appropriate levels of security dependent on the application needs.

Danfoss recommends changing the default user name and password, used to log into the AK-SM 800 series controller

Danfoss recommends changing the default web server port if used outside of secure LAN network.

Ensure the AK-SM 800 is behind a well configured firewall(i.e. port forwarding rules, FTP access, HTTP access). A well configured router/firewall will help in;

- Firewall between our controllers and the Internet
- The ability to designate the ports/protocols allowed to our controllers

The ability to limit and monitor in-store IP connections to our controllers

The AK-SM 800 controller supports auto negotiated 10/100 Ethernet speeds

The AK-SM 800 controller supports auto negotiated full / half duplex Ethernet communications

Initial Configuration - language

The following section describes the recommended actions to get your AK-SM up and running.

Local keypad - button layout

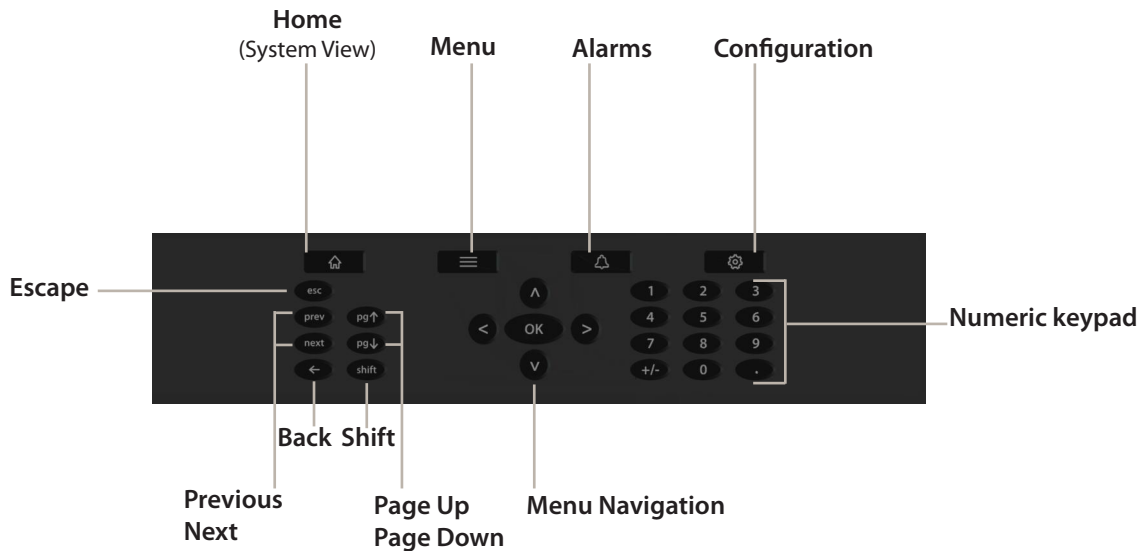

Setting language for local SM display

Your AK-SM can display several different languages. The factory default the unit will display English, in addition your required language can also be enabled. Follow the simple steps below to display your preferred language in the local screen;

1/ Press the Configuration button, and if required enter the factory default user name and password (Supervisor, 12345)

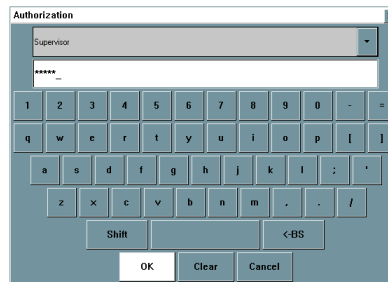

Note:

The AK-SM 800 supports standard USB keyboards. This may offer a more convenient method of text input whilst in the commissioning phase. Use the USB socket (located behind the front panel lid).

2/ Using the arrow keys, navigate to the 'System' memu.

3/ Using the down arrow, navigate to the Language line and select your required language

4/ Select your language for 'Display'. The unit will then request a reset.

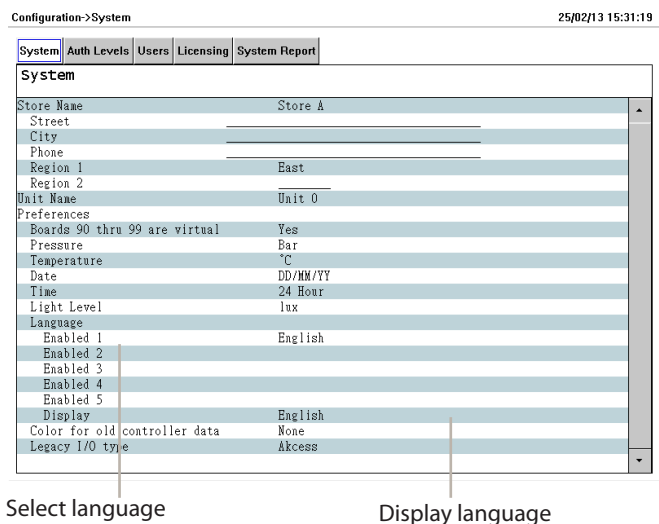

Select language

Display language

System Upload / Download

When to use Upload / Download function.

Your AK-SM 800 offers both Online and Offline configuration methods. Understanding the concept of these difference methods will help in determining the use of the Upload or Download feature.

Upload = Retrieve field bus controller device settings and sync with AK-SM 800 database

Download = Send controller device settings held in the SM800 to the field bus controller

Online Configuration:

Online configuration is where the site application has live control devices (i.e. Danfoss AK-CC 550) connected to a field bus and the SM800 will be used to configure the settings and configuration of these control devices. Since the AK-SM 800 has the ability to offer online and offline programming it is important to sync the AK-SM 800 database BEFORE attempting any online configuration or setpoint changes. The **UPLOAD** function is used to 'retrieve' the control device settings and update the SM800 database. Once the upload is performed and completed any subsequent device setpoint changes done via the SM800 will get immediately sent to the field device (no need to perform upload/download)

Upload Example: A contractor arrives on site and connects the control devices to the field bus. The contractor performs a network scan to ensure all nodes on the network are present. After the network scan the contractor performs an **upload** function, which will sync the AK-SM 800 database with the settings that exist in the field bus control devices. The upload will take the settings from the control devices and sync to the SM800 database. Once the upload is complete the contractor can continue to configure via the AK-SM 800 and change settings in the control devices.

Offline Configuration: With the use of the RMT tool, a comprehensive AK-SM 800 offline configuration can be accomplished without even being connected to any control device or AK-SM 800. For many customers and users this represents a considerable time saving in the configuration phase (assuming the site definition is known).

By selecting the appropriate AK-SM 800 simulator in the RMT tool you can simulate (in an offline state) a AK-SM 800 installation, complete with control device selections (known as EDF selections). The EDF device selections come pre-set with factory parameter settings. Once your application has been defined and any EDF setting changes made, the simulator (including all EDF's) can be saved in a AK-SM 800 database format. This saved AK-SM 800 database file can then be later loaded to a live AK-SM 800 on site and all the control device settings (contained in the EDF files) can be 'pushed down' to the relevant connected live control devices to configure them. [Note that for some Danfoss controls the Main Switch is required to be in the off mode before settings can be written].

To ensure the original 'offline' AK-SM 800 database (which holds all the control EDF device settings) is in sync with the live control devices the **'DOWNLOAD'** function is required. It is critical that the AK-SM 800 is in sync with the live control devices since the parameters in the SM800 database could be different to the parameters residing in the live control device(s). Use the Download function when you have performed an offline configuration of your application.

Download Example: A contractor opens the RMT tool and decides to fully configure the AK-SM 800 which will be used in a supermarket in the following week. He knows how many and what type of devices will be on site and decides to deploy the RMT tool to offline program the AK-SM 800 database. After selecting the device type(s), via the EDF selections the contractor decides to configure some key parameters per the customer application. Finally the AK-SM 800 database is saved to USB and the following week the contractor arrives on site. The AK-SM 800 on site is connected to all the control devices via the field bus and a network scan is performed to check field communications is valid. The contractor loads the AK-SM 800 database and performs a **DOWNLOAD** function to ensure that the settings made offline now get sent to the devices on the field bus.

The Upload and Download function can be found under Configuration>Network Nodes.

Note: Due to field bus speeds, quantity of data sets and devices the Upload or Download function can take several minutes. On sites with a large number of devices Danfoss recommends selecting 30 to 40 devices at a time and repeating the procedure.

Initial Configuration - Web Wizard

The following section describes the current Web Wizards, used for simplifying initial settings and Refrigeration layout. The Web Wizards can be used in an offline or online configuration. Danfoss recommends using the AK-SM web environment for commission tasks.

Establish a web connection to your AK-SM (if working online, enter the valid IP address of the AK-SM and apply the factory user name and password). Navigate to the **Configuration** menu

Preferences Wizard (Language, store names, units, preferences, time, date, daylight savings)

- 1/ To easily configure your units preferences, launch the Preferences wizard. Use the Wizard navigation controls to move through the Wizard screens.
- 2/ To make changes, double click on the relevant line and continue until the final screen.
- 3/ Press the finish button to complete and close the wizard (return to main wizard screen)

Users Wizard (Create, modify users, user groups, authorization levels)

- 1/ Enter number of users required (max 22), set password and browser language for each user
- 2/ Enter the number of authorization types (max 7), against the settings line double click to modify the scope of system access
- 3/ Press the Finish button to complete the Web Wizard

Licensing Wizard (Enter new license functionality)
Not currently used

Refrigeration layout Wizard

The layout wizard is designed to be used as multi use database layout tool, allowing the scan and mapping of refrigeration devices.

Make sure that the vast majority of your refrigeration devices are available and ready for layout prior to using the layout wizard. The wizard allows to scan organize and reorganize the complete layout.

Limitations: Whilst the wizard will layout the Pack and Case relationships, further controller configuration may be required. Refer to section **6** under 'Configuration' for guidance on any remaining configuration areas required. Currently the wizard is intended for Pack and Case devices and HVAC devices, any controls not designated as such will have to be configured using traditional config methods (see Configuration section).

Important Notes;

If subsequent configuration is required after an initial use of the Layout Wizard or an offline database has been loaded, go to the Configuration -> Control section to add / modify your device(s).

Only use StoreView version 1.11 and above or a live SM800 Web Browser connection when utilizing the Refrigeration configuration wizards.

To re-use the Layout wizard more than once the Refrigeration database layout needs to be reset- do this by going to the Configuration -> Control page and set # of Racks/Packs to 0. Warning- this will delete any previous Refrigeration configuration (all other configuration remains unchanged)

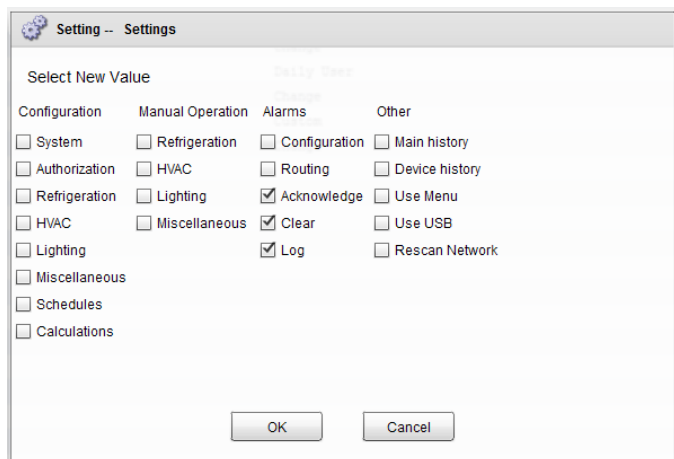
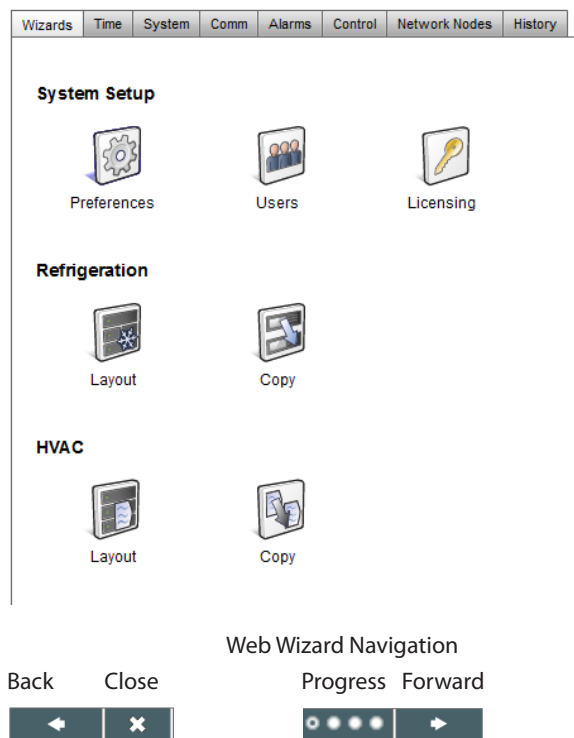

Open the Refrigeration layout wizard and follow the described steps, each step has some description for the available actions. The following wizard screens are available in sequential order;

- Network** (select and perform network scan)
- Discovery** (list scanned devices)
- Compressors** (Input Pack controller name, view address, model, add, copy, remove)
- Circuits** (Input Evaporator controller name, view address, model, add, copy, remove)
- Suction Group mapping** (Drag and drop your evap controllers under each pack)
- Summary** (view your groupings before finishing wizard and thus processing your selections to the AK-SM)

Note! For ModBus networks with >40 devices, set number of polls to 2 in the network selection screen.

Please note that the Danfoss Refrigeration gas sensors will not show up via a layout wizard scan. A manual scan is currently required to detect and configure these sensors.

After the relevant networks have been selected and scanned the 'Discovery' screen will show all detected devices. Once satisfied with the correct content press the forward button to continue the wizard.

Name	Address	Model	Type	Case #	Version	Device ID
531D1-51	51	AK-CC250-A-015x-0848B020	Case	0848B020	01.50	1.50
1	1	AK-CC250-A-015x-0848B020	Case	0848B020	01.50	1.50
2	2	AK-CC250-A-015x-0848B020	Case	0848B020	01.50	1.50
3	3	AK-CC250-A-015x-0848B020	Case	0848B020	01.50	1.50
4	4	AK-CC250-A-015x-0848B020	Case	0848B020	01.50	1.50
5	5	AK-CC250-A-015x-0848B020	Case	0848B020	01.50	1.50
6	6	AK-CC250-A-015x-0848B020	Case	0848B020	01.50	1.50
7	7	AK-CC250-A-015x-0848B020	Case	0848B020	01.50	1.50
8	8	AK-CC250-A-015x-0848B020	Case	0848B020	01.50	1.50
9	9	AK-CC250-A-015x-0848B020	Case	0848B020	01.50	1.50
10	10	AK-CC250-A-015x-0848B020	Case	0848B020	01.50	1.50
11	11	AK-CC250-A-015x-0848B020	Case	0848B020	01.50	1.50
12	12	AK-CC250-A-015x-0848B020	Case	0848B020	01.50	1.50
13	13	AK-CC250-A-015x-0848B020	Case	0848B020	01.50	1.50
14	14	AK-CC250-A-015x-0848B020	Case	0848B020	01.50	1.50
15	15	AK-CC250-A-015x-0848B020	Case	0848B020	01.50	1.50
16	16	AK-CC250-A-015x-0848B020	Case	0848B020	01.50	1.50
17	17	AK-CC250-A-015x-0848B020	Case	0848B020	01.50	1.50
18	18	AK-CC250-A-015x-0848B020	Case	0848B020	01.50	1.50
19	19	AK-CC250-A-015x-0848B020	Case	0848B020	01.50	1.50
20	20	AK-CC250-A-015x-0848B020	Case	0848B020	01.50	1.50
21	21	AK-CC250-A-015x-0848B020	Case	0848B020	01.50	1.50
22	22	AK-CC250-A-015x-0848B020	Case	0848B020	01.50	1.50
23	23	AK-CC250-A-015x-0848B020	Case	0848B020	01.50	1.50
24	24	AK-CC250-A-015x-0848B020	Case	0848B020	01.50	1.50
25	25	AK-CC250-B-015B-0848B024	Case	0848B024	01.50	1.50
26	26	AK-CC250-B-015B-0848B024	Case	0848B024	01.50	1.50
27	27	AK-CC250-B-015B-0848B024	Case	0848B024	01.50	1.50
28	28	AK-CC250-B-015B-0848B024	Case	0848B024	01.50	1.50
29	29	AK-CC250-B-015B-0848B024	Case	0848B024	01.50	1.50
30	30	AK-CC250-B-015B-0848B024	Case	0848B024	01.50	1.50
31	31	AK-CC250-B-015B-0848B024	Case	0848B024	01.50	1.50
32	32	AK-CC250-B-015B-0848B024	Case	0848B024	01.50	1.50
33	33	AK-CC250-B-015B-0848B024	Case	0848B024	01.50	1.50
34	34	AK-CC250-B-015B-0848B024	Case	0848B024	01.50	1.50

The 'Compressors' screen allows for custom text input. If working offline (programming a database not being connected to AK-SM) the Add, Copy and Remove buttons can be used.

Name	Address	Model	#Section Groups
531D1-51	51	EKC31D(11-013)-0848B007 app 061e1-1 sw 1.30 thru 1.39	1
531D1-59	59	EKC31D(11-013)-0848B007 app 061e1-1 sw 1.30 thru 1.39	1
AK-PC781-100	100	AK-PC781-040x(0802185) sw 4.00 thru 4.09	1
Controllers D	---	No Compressor	1
Controllers E	---	No Compressor	1

Double click the 'Name' line to enter a custom description for the device. Pressing return will automatically focus on the next device name in the list.

Use the Add button when creating offline nodes. Double click the 'model' line to bring up a selection of nodes

i If your scanned list has known devices that are standalone (not associated with a Pack) these must be mapped under 'No Compressor'. Manually add a new compressor and double click the model line and select 'No Compressor'. When the final wizard screen is presented any standalone controls can be mapped under this 'No Compressor' group.

Name	Address	Model
Standalone	---	No compressor

The 'Circuits' screen follows the same principle as the Compressors screen.

Name	Address	Model
Add name here.	1	AK-CC250-A-015x-0848B020 app 051e1-1 sw 1.50 thru 1.59
Case 1	2	AK-CC250-A-015x-0848B020 app 051e1-1 sw 1.50 thru 1.59
Case 2	3	AK-CC250-A-015x-0848B020 app 051e1-1 sw 1.50 thru 1.59
Case 3	4	AK-CC250-A-015x-0848B020 app 051e1-1 sw 1.50 thru 1.59
5	5	AK-CC250-A-015x-0848B020 app 051e1-1 sw 1.50 thru 1.59
6	6	AK-CC250-A-015x-0848B020 app 051e1-1 sw 1.50 thru 1.59
7	7	AK-CC250-B-015B-0848B020 app 051e1-2 sw 1.50 thru 1.59
8	8	AK-CC250-A-015x-0848B020 app 051e1-1 sw 1.50 thru 1.59
9	9	AK-CC250-A-015x-0848B020 app 051e1-1 sw 1.50 thru 1.59
10	10	AK-CC250-A-015x-0848B020 app 051e1-1 sw 1.50 thru 1.59
11	11	AK-CC250-A-015x-0848B020 app 051e1-1 sw 1.50 thru 1.59
12	12	AK-CC250-A-015x-0848B020 app 051e1-1 sw 1.50 thru 1.59
13	13	AK-CC250-A-015x-0848B020 app 051e1-1 sw 1.50 thru 1.59
14	14	AK-CC250-A-015x-0848B020 app 051e1-1 sw 1.50 thru 1.59
15	15	AK-CC250-A-015x-0848B020 app 051e1-1 sw 1.50 thru 1.59

The 'Suction group mapping' screen allows for the defined evaporator devices to be 'mapped' under the required Pack controller. This mapping forms a relationship or grouping between the pack and the evaporator devices. This grouping association will then be seen in the AK-SM configuration and dashboard screens (and can be used to easily set up master control functions like Suction optimization).

As the user description indicates, use a drag and drop action to group your controls. Use the CTRL key and multi-select cases to save time when making bulk actions. You can remove any case devices by simply dragging back to the available case list.

The check box labelled 'Allow multi-case circuit creation' is to support Centralized refrigeration control configuration, where multiple case circuits are available'. Leave this check box empty if you are using a de-centralized control strategy (i.e. Case and pack controllers)

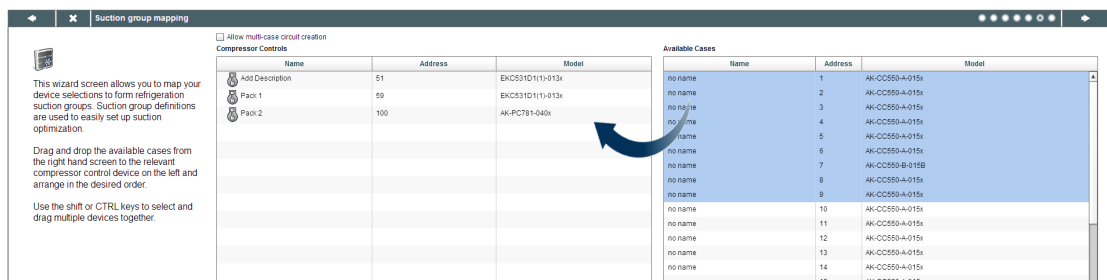

Once satisfied with the mapping, press the forward button and the summary screen will be shown. Pressing the finish button will then send your configuration layout to the AK-SM. During this time a progress bar will be shown and finally a status dialogue box.

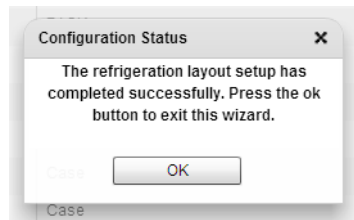
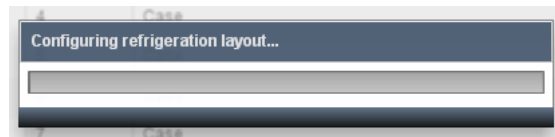

This completed wizard process will layout your refrigeration application. Typically some additional configuration tasks will then need to be completed (i.e. define alarms, setpoint changes, configure history), please refer to the following section for further details on detailed configuration.

Copy Wizard

Before performing the copy function ensure your SM 800 database is in sync with any control devices on line – refer to previous section ‘System Upload / Download’ before starting copy wizard’



The copy wizard is designed to speed up the commissioning workflow by providing the ability to define a ‘source’ device and then copy the settings to like type devices. In addition to controller settings, the copy wizard also provides the ability to define and copy alarm controller configuration and history point configuration. A new feature added under the copy wizard for version G08_031 is the ability to save / load controller settings to and from a file.

During normal operations, your AK-SM 800 auto polls certain online controller parameters to sustain communications and to refresh key parameters at regular intervals. Please note that during the copy wizard process auto polling is temporarily suspended. Polling is stopped when you reach the parameter configuration screen. Auto polling will resume after a max 2Hr timeout or completion of wizard task or if wizard is cancelled, whichever is first. To cancel the wizard at any time only use the top left close ‘X’ button.

Some Danfoss controllers require that the ‘Main switch’ is OFF before allowing any parameter changes. To accommodate this fact, the copy wizard will automatically turn off the main switch for the source and destination controller(s). The main switch will be reverted to original position after the copy or copy/download is completed. Since the copy wizard changes the state of the device main switch, please pay special attention to operational conditions (i.e. food temperature) during this operation and validate all devices are correctly running after copy completion or cancellation of copy wizard. Failure to review device status may result in devices being left with main switch off (i.e. no refrigeration).

Important limitations

The copy wizard is currently not designed to fully support the Danfoss AK2 platform of devices (i.e. AK-PC 781, AK-CC 750..) since these devices have a different framework than other Danfoss controllers. When using the copy wizard in an on-line environment (connect to active controller network) the copy wizard will only allow ‘Alarms and History’ points to be set and copied. For full configuration of AK2 device parameters Danfoss recommends using the available Service Tool to facilitate commissioning on these device types.

Please note that the copy function will only work against same device, application/code type and is not designed to fully support Danfoss AK2 style controllers.

Preparation

Online Configuration

For onsite (online) commissioning, the copy wizard assumes all relevant controller devices are installed on the network, have correct addressing, and if relevant application type set. Naming of the asset will also help in the copy wizard due to easy recognition of your devices. The ‘Layout wizard’ can assist in this preliminary task.

During the final copy/download phase, the main switch of the target device(s) will be switched off then on after the copy/download is complete.

Offline Configuration

The copy wizard can be used in an online or offline (via RMT simulator) environment.



Before using the copy wizard make sure the source device is fully configured (settings, history, alarms). Whilst it is possible to use the copy wizard to set up the source device, it is not recommended and has been seen that potential errors can occur with this workflow – please configure the source device first (outside of the copy wizard). Once source device is configured the copy wizard can be used, do not make any changes (settings, alarms, history) to the source device whilst in the copy wizard.

When copying history. Be aware, that the copy process always keeps existing logs in the destination and new logs will be added.

BE SURE TO VALIDATE MAIN SWITCH STATUS AFTER COPY WIZARD

NOTE!

When assigning history points to a controller device a recommended max of 100 points per device is allowed. Assigning more than 100 points per device will cause points not to record log history

Configuration

The following section describes the typical steps required for commissioning and configuration of your AK-SM. Although site applications can differ from one site to another, many setup procedures are common. This setup section assumes the AK-SM is mounted and all necessary power, network cabling and controllers are in place. The described work flow is based around the AK-SM web browser interface, but would equally apply if being done via the local screen. Further detailed commissioning instructions are found throughout this user guide.

The AK-SM offers unique control flexibility in that both centralized and de-centralized control methods are supported. The term 'centralized' is used to describe the control of refrigeration Racks via I/O (Danfoss Input / Output modules). Under this method of control the refrigeration control is managed directly from the front end (AK-SM), with field bus I/O. De-centralized control is the term used to describe the full support of Danfoss Pack and Case controllers. Under this method, each Pack or Case controller on the network can be seen as self contained, with control logic built in. The front end (AK-SM) under this type of application is more of a network manager, providing full read / write access and energy saving functions.

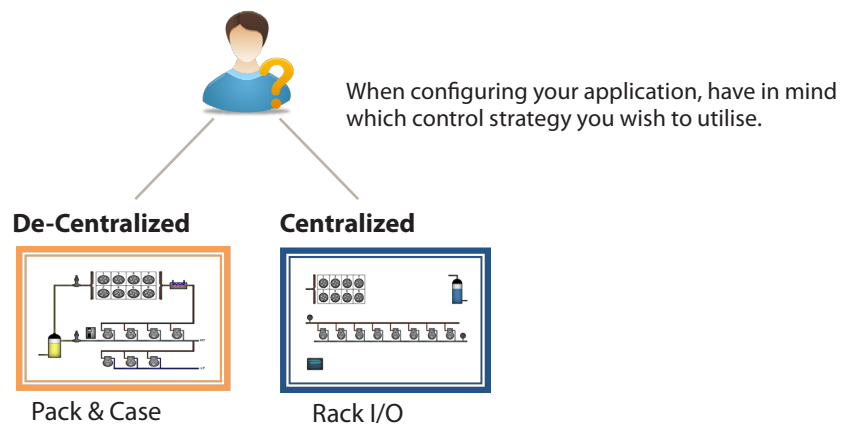

When starting your system configuration you will have the opportunity to select either Centralized or De-centralized (or a mix of both) control methods.

The following areas of system configuration will be covered in this section;

- 1 **Network Nodes** (Network scan/ Node overview, Points, scan /config status, duplicates, upload/download)
- 2 **Time** (Set time/date, time zone, operating Hours, Daylight savings, Holidays)
- 3 **System** (Store / Region Names, Units preferences, Authorization levels and users)
- 4 **Communication** (DNS, DHCP, IP Ports)
- 5 **Alarms** (XML, e-mail, Routing)
- 6 **Control** (Configure Refrigeration, Lighting, Miscellaneous, Energy meters and Gas detection)

Once successfully logged into the AK-SM (web) and assuming you have the required authorization, system configuration is done via the central 'Configuration tab'. Clicking this tab reveals the configuration 'sub tabs'. Depending on your selection, these sub tabs will change dependent on content. Using the menu structure seen in the 'Configuration' page, a step by step process can be applied when setting up your AK-SM.

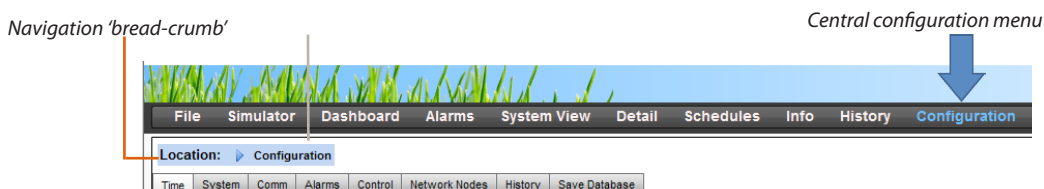

1 Network Nodes

If your application already has controllers and/or I/O modules set and powered you may wish to perform a network scan to validate their connection to the AK-SM. Follow this section to perform a network scan

From the Configuration tab select the 'Network Nodes' sub-tab. When your field network is complete and all controllers are on line a network scan can be initiated. The operation of a network scan allows the AK-SM to be aware of any controller devices on the network, allowing the AK-SM to communicate and function with the controllers on the field bus.

Note! For ModBus networks with >40 devices, set number of polls to 2 in the network selection screen

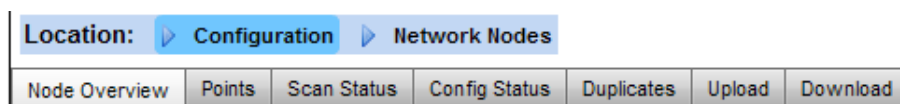

Use this screens to perform network scan

Relays | Sensors | On/Off | Variable Output

This tab relates to any AK I/O configured points, the term **points** relates to AK I/O relay, sensors, On/Off Inputs and variable outputs. Any control questions that have required AK I/O control will be seen in these tabs. The purpose of these tabs is to allow the viewing of the I/O point status.

Use this screens to view status of your assets (Online)

All nodes | Controllers | I/O boards | Other nodes

The scan status menu/tabs allows the user to view any scanned nodes found on the network.

All Nodes: Central list will display configured devices and points. Only configured controllers will be visible in this list.

Controllers: view any scanned generic controllers. This screen will also reflect address and controller type

I/O Boards: Display AK Board & Point status.

Other Nodes: List of other nodes

Duplicates Tab

Check this list to make sure no two devices have been assigned the same network address. Any duplicate address will be shown in this list. Correct any address issues and re-scan.

Upload Tab

The upload tab will list any controllers that have been uploaded. The upload function can be performed in the Configuration->Control area (one controller at a time) or here (multiple devices with one command). The process of an upload takes the current parameter settings and values from the controller(s) and loads them into the AK-SM database. This operation ensures that the AK-SM database is synchronised with any pre-configured controllers on the control network. Any upload failure will be shown on this screen, else a time / date stamp will be shown when successful

Download Tab

The download tab will list any controllers that have been processed for download (where the AK-SM sends parameter data to the device). The download function can be performed individually under the Configuration->Control page or here, where multiple controllers can be selected for download (using one command). The process of a download takes the AK-SM database values and downloads them to the selected controller(s). Any upload failure will be shown on this screen, else a time / date stamp will be shown

Ensure the appropriate network channel is selected, and press the 'complete rescan' line. The AK-SM will now scan the network to identify any connected and addressed controller nodes. The text on the screen will reflect the scan progress, after a scan the time & date will be shown (indicating last scan)

For SLV support, select Modbus channel

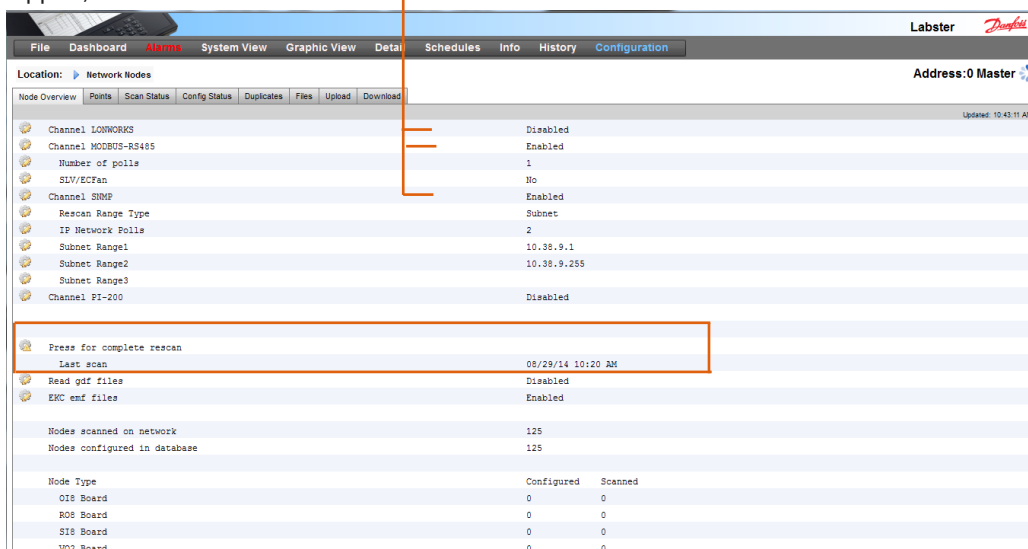

After the network scan has completed, any resulting count will be seen against the **Nodes Scanned on Network** line - this reflects the number of found nodes on the scan just completed. The corresponding line below (**Nodes configured in database**) reflects the current total of network nodes actually configured in the AK-SM database.

The last group in this table refers to the following node types;

- OI (Output|Input)
- RO (Relay output)
- SI (Sensor Input)
- V02 (Variable output)
- Utility Meter (WattNode, Veris, Carlo Garvazzi)
- Generic (Danfoss case / pack controllers)
- AK-CM (AK- Communication Modules)
- Calculations

Press for complete rescan		
Last scan		01/01/70 12:00 AM
Nodes scanned on network		0
Nodes configured in database		42
Node Type	Configured	Scanned
OI8 Board	0	0
RO8 Board	0	0
SI8 Board	0	0
V02 Board	0	0
Utility Meter	1	0
Generic	32	0
AK-CM	9	0
Calculations	0	N/A

Each node (type) has a column that reflects any configured or scanned status.

2 System configuration (Time settings / preferences)

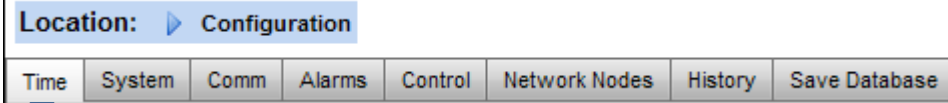

The Time tab allows the *system time, time zone, operating hours, daylight savings and holidays* to be configured. Double click a line to make any changes.

The following examples can be seen for the time zone;

- London (GMT) = 000
- Central Europe = 100
- East Coast USA = -500

The operating hours can be set that reflect your store operating hours. Any times set in this section can then be referenced to via a 'Relative schedule'. Relative schedules are found under the 'Lighting' and 'HVAC' application areas and apply a (user selectable) offset which references the operating hours schedule.

Holiday's for full days must be operated with 00:00 open to 00:00 close and not 00:00 open and 23:59 close or 00:01 open and 00:00 close.

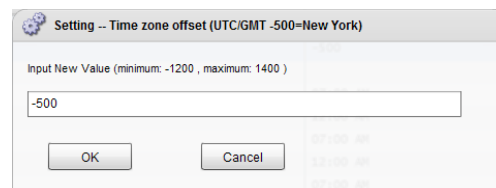

3 System configuration (Time settings / preferences)

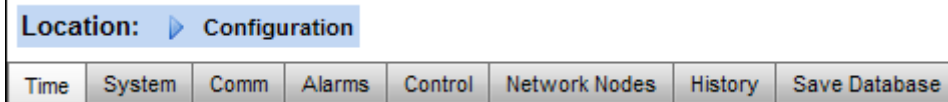

After completing the required settings in the 'time' tab, navigate to the 'system' tab. Under the system tab add the store name and region / preference setting and information.

Location: Configuration System

System	Auth Levels	Users	Licensing	System Report	Files
--------	-------------	-------	-----------	---------------	-------

Use this screen to configure 'Store name/details, unit name, preferences, system language'. Double click the appropriate line to make changes

'Color for old controller data' is an option to reflect data that has yet been updated via a network poll. Data with a * indicates either an offline condition or that the AK-SM is waiting for a fresh update from the device

Legacy I/O type is used to set legacy supported devices

Reflects what license is configured for your AK-SM. Different license allow additional functionality

The Users screen allows the definition of up to 20 users

The Auth (Authorization) screen allows the definition of up to 7 authorization types.

The system report screen allows the user to define what content should be included. Alarms, Schedules, scanned devices, Audit trail and controller database are available options. To generate a system report go the main web menu and select File/Download Report

Location: Configuration System

System	Auth Levels	Users	Licensing	System Report	Files
--------	-------------	-------	-----------	---------------	-------

The Auth (Authorization) Levels tab allows the definition of up to 7 authorization types. Custom authorization types can be configured with certain system privileges / access. In the example below, 4 auth levels have been defined (factory setting is 3). Level 1 (Supervisor) cannot have the settings changed. To change the level of access of other auth levels, navigate to the desired line and select from the Authorization pop up dialog box. As factory standard, 3 levels are predefined (Supervisor, Service, Daily User), the service and daily user levels can be changed as required.

Location: Configuration System

System	Auth Levels	Users	Licensing	System Report	Files	Secret
Number of authorization types				4		
Level 1				Supervisor		
Settings				All		
Level 2				Service		
Settings				Change		
Level 3				Daily User		
Settings				Change		
Level 4				Danfoss Custom		
Settings				Change		

To add/delete auth levels select the 'Number of authorization types' line (max 7 levels)

The Supervisor name can be changed but the level of access / privileges are factory set.

Adding new auth levels allows new users to have specific access to key system areas. Once new auth types have been created, enter custom name and define level of access by selecting the Settings line (Authorization pop up box will appear)

The following areas of authorization are available;

Configuration

- System:** Access to the System tab
- Authorization:** Access to the Authorization tab
- Refrigeration:** Access to Refrigeration configuration
- HVAC:** Access to HVAC configuration
- Lighting:** Access to Lighting configuration
- Miscellaneous:** Access to Misc configuration
- Schedules:** Access to Schedule configuration
- Calculations:** Access to Calculations configuration

Manual Operation (seen under Service tab in device detail page)

- Refrigeration:** Allow user to perform the following operations on Danfoss case controllers ; Main Switch, Defrost, Cleaning, Lights, Night Setback, Shutdown
- HVAC:** Allow user to perform the following operations to Relay, Inputs & sensor overrides
- Lighting:** Allow user to perform the following operations -override relay
- Miscellaneous:** Allow user to perform the following operations -override relay, sensor inputs

Alarms

- Configuration:** Allow user to configure alarms
- Routing:** Access to the alarm routing
- Acknowledge:** Allow user to acknowledge
- Clear:** Allow user to clear alarms
- Log:** Allow user to set alarm level to log

Other

- Main Menu:** Allow user to access main menu
- Device History:** Allow user to access device history
- Use Menu:** Allow access to Menu function
- Use USB:** Allow use of USB flash
- Rescan Network:** Allow user to rescan network

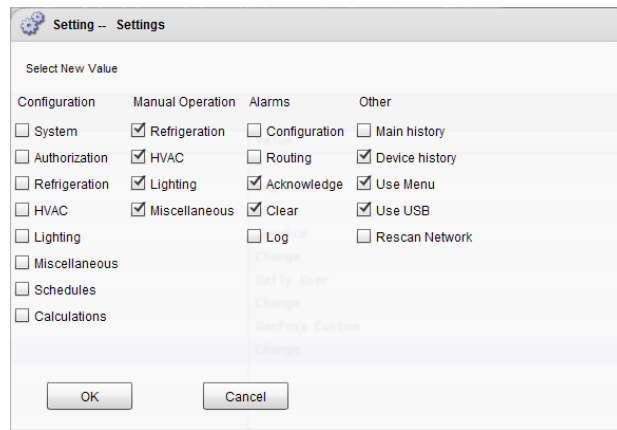

Location: Configuration System

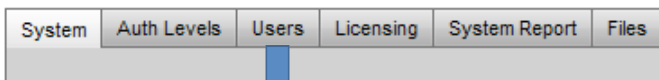

Users tab

The next tab (user tab) allows the definition of up to 20 users. A custom name and password can be given for each user. The appropriate level (defined in Auth Level tab) can be assigned to each user. The AK-SM always maintains a single user in the system profile and this level is factory set to the Supervisor level. To add users simply enter the required value in the 'number of users' line. The Browser language line reflects what language will be displayed in the web browser upon this user logging on [via browser access].

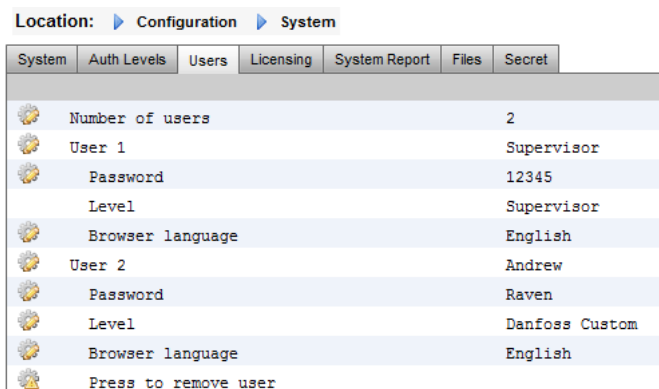

To add users select the 'Number of users' and enter required number

Enter custom name, password and auth level for user.

Browser Language: This defines the language that will be displayed when the user log on via the web browser access.

4 Communication

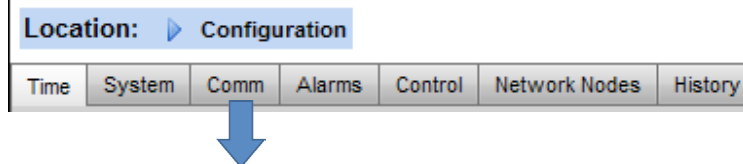

The Comm (Communications) screen allows for IP network settings to be configured. Follow the question lines on the screen to configure your AK-SM according to site requirements. Any changes in IP configuration will require an AK-SM system reset.

Location: Configuration	
Comm	
Name	Value
Press to reset this unit	
Internet	Yes
NOTE: Reset unit after making changes!	
Use DNS	Yes
Use DHCP	Yes
Use IP address as backup if DHCP fails	No
Master IP Address	
Preferred Hostname	Yes
Master Node Name	
No of Ext. Internet	0
Web Server Port	80
FTP Server Port	21
FTP Data Port	20
Network timing support	No

Select 'Yes' if a DNS service is to be used. Preferred host name can be entered if setup in router config
 Select 'Yes' if AK-SM is to be connected to a DHCP server

Select yes and manually enter the IP address that the AK-SM will use if DHCP fails.

Master IP address - if using multiple AK-SM controllers in a host network, enter the Master (unit address 0) IP address

Internet IP address - Specify public IP address which is used to contact your AK-SM via an Internet based connection. Factory web (HTTP) port is 80 & FTP port is 20 and 21, both can be changed to suit your network application.

If your network supports NTP, select 'yes' to the question 'Network timing support?'

5 Alarms



The Alarms screen has a sub set of screen [Connections, Service, Alarm Routing, Relays, System, I/O Comm]. Go through each sub tab to ensure all areas are correctly configured as per site requirements.

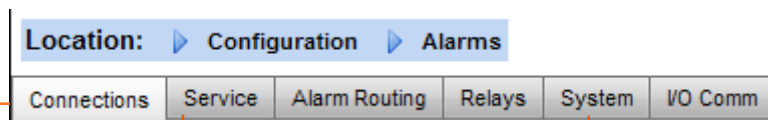

Define the number of connections (typically network should be selected), then select the connection type [e-mail, Remote (Danfoss Retail Care), XML]

The service tab is designed to allow test alarms to be generated. There is also an auto alarm test that can either be on a scheduled or repeated basis.

The AK-SM utilizes an Alarm Action Matrix that allows a high degree of flexibility for various alarm routing options. At the heart of the alarm configuration is the **'Alarm Routing'** page, where different routing options can be defined, along with time delays and alarm output stop conditions.

AK-SM system based alarm conditions should be set under the **System** tab.
 If the alarm output includes relay(s) the **Relays** tab should be accessed to configure the board & point address for these relays

If Controllers (Danfoss Evap & Pack, Power meters) and, I/O has been used in the control configuration (Lighting, HVAC, Refrigeration etc.), these devices can be seen under the I/O Comm tab.

Connections screen - Define the number of connections, then select the connection type. Your AK-SM can offer the following alarm IP based alarm output; e-mail, Remote (Danfoss Electronic delivered services) and XML. Depending on your configuration the screen will reflect the required inputs in order to satisfy the output. In order for any alarms to be routed out of your AK-SM please ensure a schedule is configured. Failure to set a schedule will inhibit any alarm output.

Location: Configuration Alarms

Connections	
Name	Value
Number of network connections	1
Network Connection 1	
Type	XML
Name	
Address	
Date	MM/DD/YY
Lang	English
Time	24 Hour
Port	3001
Delay	5 min
Schedule 1	Standard
From	00:00
To	00:00
Days	SMTWRFA
Holidays	12345678
Schedule 2	Not Used

To configure a network connection select 'Number of network connections'

Type (e-mail | Remote | XML)

Ensure a schedule is defined to allow alarm output

Example of e-mail configuration

Location: Configuration Alarms

Connections	
Name	Value
Number of network connections	1
Network Connection 1	
Type	E-Mail
E-Mail Configuration	
Server	
Type	Name
Name	smtp.danfoss.net
Use authentication	Yes
User name	your value here..
Password	your password
Send To	
1	andrew@mytest.com
2	dave@mytest.com
3	
Reply To	anyaddress(mytest.com
Send abbreviated alarm message	No
Date	MM/DD/YY
Lang	English
Time	24 Hour
Port	25
Schedule 1	Standard
From	00:00
To	00:00
Days	SMTWRFA
Holidays	12345678
Schedule 2	Not Used

Enter valid server name (or IP) for e-mail server
If your e-mail service requires user authorization, enter user name and password
Note!
SSL is not supported

Send to: Add the e-mail address for intended recipients

Reply to: A mandatory field that must have a valid entry (address with same domain name). An abbreviated message would have reduced text in the alarm message

Configure a schedule to enable the alarm e-mail output

3G Wireless routers

3G technology offers many benefits over standard dial up connections. Utilizing a 3G connection the full range of AK-SM services can be used, including web browser, and RMT. Where Internet / Intranet connection is not available, Danfoss recommends considering 3G as a means of offering IP connectivity. Please consult your local Danfoss sales office with regard to 3G connectivity.

Service tab

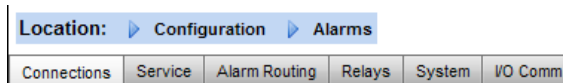

Use the service screen to send test alarms. You may configure the alarm type and alarm action logic (1-8). In addition, scheduled or repeat test alarms can be configured on this screen. The internal alarm relay can also be tested from this screen.

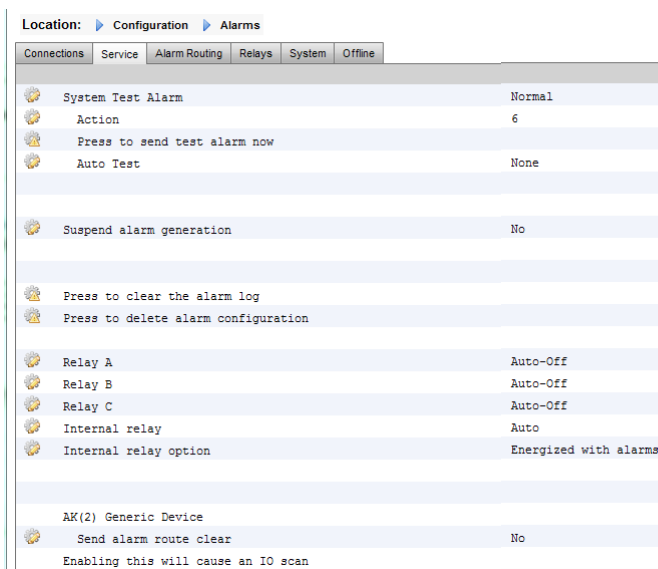

'Version VG08_021 introduces a new user option for the internal alarm relay. If using the internal alarm relay please validate correct setting for your application'

Routing tab

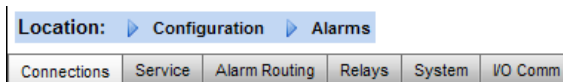

The AK-SM utilizes an Alarm Action Matrix that allows a high degree of flexibility for various alarm routing options. At the heart of the alarm configuration is the '**Alarm Routing**' page, where different routing options can be defined, along with time delays and alarm output stop conditions.

The central alarm action matrix allows various output options (known as alarm **actions**) and alarm handling configuration to be centrally assigned. Once the alarm action matrix has been defined, any controller or I/O point can be given an alarm **action** number. The alarm **action** number corresponds to the appropriate output. (as defined in the alarm routing page). Alarm output options include;

- 5 external (AK I/O) relay outputs
- Local AK-SM buzzer
- Local AK-SM front LED
- Internal alarm relay
- 2 Network connections
- 6 IP / e-mail addresses (3 per alarm receiver)

The following example can be seen as a guide to configuring your AK-SM alarm logic options;

- Disabled** = No alarms will activate on this point
- Log Only** = When an alarm occurs on this alarm point it will only register in the AK-SM alarm log - no physical alarm output
- Normal** = When alarm is active the output will be sent once (alarm may get re-triggered if the stop condition is set for repeat)
- Severe** = When alarm is active the output will get re-sent every xx min
- Critical** = Same as Severe but with separate re-trigger time - when alarm is active the output will get re-sent every xx min
- Delete** = Removes any applied alarm settings

Select Alarm Action type (defined under Alarm routing)

Auto Test:

- Scheduled: Configure days & time for test alarm
- Repeated: Configure interval time for test alarm

Suspend alarms generation (suspend All alarms in the system from being sent): Set time period (min/Hrs) to stop alarms being sent

Any relays configured for alarm output can be forced on / off for testing purposes.



Remember to leave in Auto position after testing

The line item AK(2) Generic Device – 'Send alarm route clear' is used, to clear the alarm route in ALL connected Ak2 controllers and is required if the AK2 controller was connected to another Danfoss system prior to getting connected to the AK-SM800 series (i.e. AKA Gateway/SM720).

Change the parameter to YES and a scan will be initiated, the alarm route in AK2 will be reset, and your AK2 devcie(s) will now have valid alarm routing.

To configure an alarm action, navigate to the required output line (I.E. Relay A) and press enter. The resulting screen allows the configuration of the alarm actions, any pre delays, duration times and stop conditions. The results of this configuration will be shown in the alarm routing page.

Alarm Actions (1-8)

Up to 8 alarm actions can be defined. Each alarm action can have multiple outputs, making the AK-SM alarm output options very flexible. 'Look down' each alarm action number column and any associated outputs will be seen in the left hand column

Component Column (alarm output)

Select from the options seen in this column;

- Relay A-E
- Front LED
- Buzzer
- Int. Relay
- Network 1
- Network 2

	1	2	3	4	5	6	7	8	Del	Dur	Stop
Relay A	-	-	-	-	-	-	-	-			
Relay B	-	-	-	-	-	-	-	-			
Relay C	-	-	-	-	-	-	-	-			
Relay D	-	-	-	-	-	-	-	-			
Relay E	-	-	-	-	-	-	-	-			
Front LED	-	-	-	-	-	-	-	-			
Buzzer	-	-	-	-	-	-	-	-			
Int. Relay	-	-	-	-	-	-	-	-			
Phone 1	-	-	-	-	-	-	-	-			
.....	-	-	-	-	-	-	-	-			

Delay

Once an alarm action is defined the associated time delay for the action can be set. This delay is in addition to any delay already defined in any controller (i.e. EKC) or monitoring points (i.e. I/O) defined in the system.

Duration

A duration time is available when either Time or Time/Repeat are selected as stop conditions. The duration setting defines the length of time the alarm output will be active for (irrespective if the alarm is still active or acknowledged or not)

Available in second or minute selections. 0 Sec/Min duration will result in the alarm output remaining off.
 Min = 0 Sec/Min
 Max = 99 Sec/Min

Stop

The stop condition defines when the alarm output will stop or return to configured position. The following definitions apply;

Time = Stop on time (set under duration)

Ack = Stop on alarm being acknowledged

Clear = Stop when alarm clears

Time/Rep = Stop after time delay but repeat if alarm is still active

Ack/Rep = Stop after alarm is acknowledged. If alarm still

active after acknowledge repeat alarm action (repeat

Alarm Actions (1-8)

Each alarm action can have multiple relays, IP address, etc assigned

Custom text that better reflects the alarm relays can be entered.

Use the 'component name display' to toggle between custom text & factory name (Relay A, Relay B...)

Alarm output options

Select the appropriate 'component' (i.e relay, network) and configure by double clicking on the appropriate line

Location: Configuration Alarms			
Alarm Routing			
Name	Value		
Component name display	Items		
Component	Action Del Dur Stop	Delays & Stop conditions	
Relay A	X----- 10s --- Clear		
Relay B	-D----- 0m --- Ack		
Relay C	--N----- 0m 10m Time/Rep		
Relay D	----- --- --- ---		
Relay E	----- --- --- ---		
Front LED	XXXXXXXXX 0m --- Clear		
Buzzer	----- --- --- ---		
Int. relay	----- --- --- ---		
Network 1	X----- 1m --- Clear		
Network 2	----- --- --- ---		
Repeat delay after stop	5 min		
Send critical alarms, every	60 min		
Send severe alarms, every	1440 min		

Set pre delay, duration and stop conditions (for each alarm output selection)

Example configuration

This example will describe the steps to configure an alarm actions. Alarm action **1** will be defined according to the following;

- **Relay A** should trigger after a 10 second pre delay. This relay will energize any time and will only reset when the alarm clears.
- **The Front LED** should activate (de-activate LED when alarm clears)
- **The Buzzer** should only activate during the Day (Buzzer stops when alarm is Acknowledged)
- Alarm message should also be sent out via **e-mail**

The above alarm outputs are associated with action 1 - 'look down' the alarm action 1 column and the relevant outputs can be seen in the left of the page.

To define the alarm output options navigate down the page and double click the relevant line.

This opens another page that allows the configuration for that output to be set. In the example below **Relay A** and the **Buzzer** can be seen. Follow the same process for the other outputs. For e-mail output, navigate to the Network 1 line and press enter. Here, set the action, time delay & stop conditions. (The actual e-mail configuration is done in the Alarm 'Connections' page).

'Look down' Alarm action 1 column

The results of the alarm output configuration can be seen in the central Alarm Routing page. Follow this process for other actions.

Relay A Configuration page

Alarm Routing	
Relay A	
Name	Value
Usage	Relay A
Action 1	Enabled
Action 2	Not selected
Action 3	Not selected
Action 4	Not selected
Action 5	Not selected
Action 6	Not selected
Action 7	Not selected
Action 8	Not selected
Delay	10
Units	seconds
Stop	Clear

Alarm Routing				
Name	Value			
Component name display	Items			
Component	Action	Del	Dur	Stop
	12345678			
Relay A	X-----	10s	---	Clear
Relay B	-----			
Relay C	--N----	1m	10m	Time/Rep
Relay D	-----			
Relay E	-----			
Front LED	XXXXXXXX	0m	---	Clear
Buzzer	D-----	0m	---	Ack
Int. relay	-----			
Network 1	X-----	1m	---	Clear
Network 2	-----			
Repeat delay after stop		5 min		
Send critical alarms, every		60 min		
Send severe alarms, every		1440 min		

Alarm Routing	
Buzzer	
Name	Value
Usage	Buzzer
Action 1	Day
Action 2	Not selected
Action 3	Not selected
Action 4	Not selected
Action 5	Not selected
Action 6	Not selected
Action 7	Not selected
Action 8	Not selected
Delay	0
Units	minutes
Stop	Ack

Action settings:

Once in the actual output page, navigate through the lines and set the relevant Action. Each action can have the following settings;

Not Selected: No action

Enabled: Will enable this output action (any time of day)

Day: Enable this output during day status (based on store opening times (Configuration->Time)

Night: Enable this output during night status (based on time outside of store opening times (Configuration->Time)

Delay, Units & Stop settings:

To complete the output configuration set the time delay, units & stop conditions should be set. Stop conditions;

Time = Stop on time (set under duration)

Ack = Stop on alarm being acknowledged

Clear = Stop when alarm clears

Time/Rep = Stop after time delay but repeat if alarm is still active

Ack/Rep = Stop after alarm is acknowledged. If alarm still active active after acknowledge repeat

Relay tab

Location: Configuration Alarms

Connections	Service	Alarm Routing	Relays	System	I/O Comm
-------------	---------	---------------	--------	--------	----------



If the alarm output includes relay(s) the **Relays** tab should be accessed to configure the board & point address for these relays. The example below shows relay A & C, with the associated (AK I/O) board & point address.

Relays	
Name	Value
Relay A	Relay A
Address	01-1.1
Type	N-Open
Relay C	Relay C
Address	01-1.2
Type	N-Open

Enter the AK I/O board & point location for the relay(s)

Select N-Open / N-Closed as required

System tab

Location: Configuration Alarms

Connections	Service	Alarm Routing	Relays	System	I/O Comm
-------------	---------	---------------	--------	--------	----------



AK-SM system based alarm conditions should be set under the **System** tab. The alarms seen in this page are factory set but can be changed as per site requirements. Navigate down each line and configure (pressing the enter key) as required. The following items can be seen and changed under the System tab;

I/O Network Fail: Alarm if communications to AK I/O fails

Flash Memory fail: Alarm if AK-SM system memory fails

Database Cleared: Alarm if AK-SM database is cleared

File Error: Alarm if critical files do not load / not present on AK-SM system (I.E. Device list missing)

Alarm send fail: Alarm if any active alarms were unable to be sent out

NTP Failure: Alarm if the network time protocol fails

Host Comm: Alarm If host communication fails

Host Count: Alarm if one or more AK-SM units disconnect from host network

Ram Disk Full: Alert alarm if Ram is getting full (due to EDF files)

System	
Name	Value
Host Comm error	Normal
Action	1
Host count error	Normal
Action	1
I/O Network fail	Normal
Action	1
Flash memory fail	Normal
Action	1
Database Cleared	Normal
Action	1
File Error	Normal
Action	1
Alarm send failed	Log Only
Low battery	Critical
Action	1
NTP Failure	Log Only
RAM disk full	Normal
Action	1

Factory settings can be changed as per customer requirements.

Alarm level & Actions can be changed

I/O Comm tab

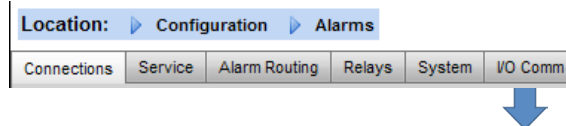

If Controllers (Danfoss Evap & Pack, Power meters) and, I/O has been used in the control configuration (Lighting, HVAC, Refrigeration etc.), these devices can be seen under the I/O Comm tab.

The I/O Comm tab allows any offline communication alarms to be configured. The example below shows an evaporator controller (address 1) with the alarm level set to 'Normal' & alarm action '1'. These factory settings can be changed in this page.

Any AK I/O points used in the AK-SM system can be found on this page, with the associated alarm level and actions set. The factory settings can be changed as required.

Location: Configuration Alarms I/O Comm					
Controllers					
AK-CM Calculations Other					
Name	Type	Address	Status	Alarm	Value
	GN	1	Online		Normal
	Action				1
	GN	2	Online		Normal
	Action				1
	GN	3	Online		Normal
	Action				1
	GN	4	Online		Normal
	Action				1
	GN	5	Online		Normal
	Action				1
	GN	6	Online		Normal
	Action				1
	GN	7	Online		Normal
	Action				1

Calculations & Other

If any calculations have been defined in the AK-SM system, alarms can be associated with these. Use the Calculations tab to set appropriate alarm levels and actions.

6 Control tab

The control tab is the central configuration page for your control requirements. It lays out the different application areas and allows the Commissioning Engineer to define what applications are on site. Once the application areas are defined on this page, more detailed commissioning is done in the dedicated application tabs (covered in following section). Note that depending on your license version, different applications may be visible (or not). Please also note that the SM provides the ability to configure centralized or de-centralized control. **Centralized** control is where your SM has the control logic built in and uses Danfoss I/O to provide refrigeration control. **De-centralized** is the control method via the use of Danfoss Pack and case controllers

For de-centralized control, ensure the control type is set to your required controller type (via drop down menu)



For centralized control, ensure the control type is set to IO (input/output). This alerts the SM that you wish to use Danfoss Board and Point configuration for your refrigeration application

Location: Configuration Control

Control	
Name	Value
Show only scanned devices	No
Refrigeration	
Dewpoint method	Calc Dewpt
Humidity sensor to use	Inside RH 1
Number of racks/packs	1
Pack 1	AK-PC730-021x 08020118
Number of drives	0
Number of circuits	0

De-Centralized

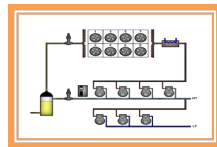

Pack & Case

Centralized

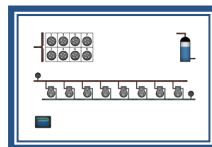

Rack I/O

Refrigeration	
Dewpoint method	Calc Dewpt
Humidity sensor to use	Inside RH 1
Number of racks/packs	1
Rack (A)	AK-I/O
2 stage system	No
No of suction groups	5
Condenser type	Air cooled

Show only scanned devices:

Select 'yes' if your controller devices are already on the network, with valid addresses and connected to the AK-SM. By setting to 'yes' and after a network scan (covered in next section) only discovered devices will be shown in the drop down boxes. If your controllers are not yet on the network, keep this selection to no.

Number of Racks / Packs (max 12):

Enter the required amount of suction groups.

Rack type (Use I/O selection for centralized control, select controller type if using de-centralized)

Location: Configuration Control

Control	
Name	Value
Show only scanned devices	No
Refrigeration	
Dewpoint method	Calc Dewpt
Humidity sensor to use	Inside RH 1
Number of racks/packs	1
Rack (A)	AK-I/O
2 stage system	No
No of suction groups	5
Condenser type	None
HVAC	
Number of HVAC units	0
Lighting	
Number of lighting zones	0
Misc	
No. of relay outputs	0
No. of sensor inputs	0
No. of on/off inputs	0
No. of variable outputs	0
Energy	
Number of meters	0
Leak	
Number of leak detectors	0
Manager's Override	
Number of overrides	1

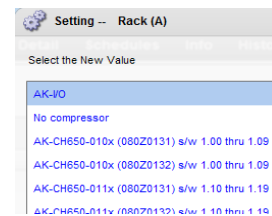

AK IO = built in control via AK I/O
No Compressor = No Compressor control
Device selection = select required controller
Note: Variable speed drive can be selected as a pack controller.

Suction groups (Suction group or Evaporator control)

Add your required quantity of suction groups (centralized logic) OR enter how many evaporator controls are available under your Pack (de-centralized)

Note: suction group / evap configuration is then done under the Refrigeration tab

The following screen shots below represent an example of de-centralized configuration (Pack and Case control). The AK-SM has been configured for two pack controllers (AK-PC 730 and the AK-PC 840), with 5 Evaporator controllers under each pack. Selection for each Pack controller was made via the pop up box that appears when the Rack line is double clicked.

Location: Configuration Control

Control Refrigeration Misc Energy Leak Light HVAC

Control	
Name	Value
Show only scanned devices	No
Refrigeration	
Dewpoint method	Calc Dewpt
Humidity sensor to use	Inside RH 1
Number of racks/packs	2
Pack 1	AK-PC730-020x 080Z0119
Number of drives	0
Number of circuits	5
Pack 2	AK-PC840-023x 080Z0115
Number of drives	0

Double click to select your required Pack device

Once the Pack controllers have been defined and the number of case controllers under each pack have been set, continue to the Refrigeration tab for detailed configuration.

Location: Configuration Control Refrigeration

Control Refrigeration Misc Energy Leak Light HVAC

Location: Configuration Control Refrigeration

Rack Suction Circuits Condenser Drives Rail Heat Addresses Schedules

First, navigate to the 'Address' tab. Enter a valid network address, corresponding to the address already set in the field controllers.

Note: If your field controllers have already been configured with the relevant parameters set, you may wish to perform an 'Upload'. This function forces the AK-SM to pull back the controller settings and thus synchronize the AK-SM database. Only use the 'Download' function if you have finished controller configuration on the AK-SM and you wish then to send these settings 'down' to the controller.

A one click option for this (upload/download) can be found under the Configuration->Network Nodes tab

Location: Configuration Control Refrigeration Addresses

Controllers Relays Sensors On/Off Inputs Variable Outputs VLT

Pack 1

Controllers	
Name	Value
Pack 1 AK-PC730-020x	Pack 1
Address	0
Download	
Upload	
My custom name not cfg	My custom name
Address	0
Download	
Upload	
meat case not cfg	meat case
Address	0
Download	
Upload	
T&A Case not cfg	T&A Case
Address	0
Download	
Upload	
Circuit AA4 not cfg	Circuit AA4

Set a custom name for your control devices

Enter address that matches the physical address in the pack and case controllers

See above note about Download / Upload

Once all the addresses and custom naming is complete escape out of the addresses menu and navigate to the 'Suction' tab. This will allow for configuration of the Pack Controller(s). Use the drop down (Suction) menu to access each Pack controller and the corresponding menus. Please note that any online controller devices will invoke a dialog box which asks if you wish to retrieve the data from this controller. This dialog box is intended to direct the choice of either uploading data from a controller (overwriting any previous settings held in the AK-SM database) or not. If you have existing controllers on the network which have already been configured, choose the upload option (this need only be done once for each controller you view).

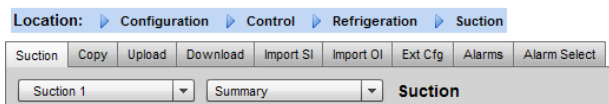

Location: Configuration > Control > Refrigeration > Suction

Suction Copy Upload Download Import SI Import OI Ext Cfg Alarms Alarm Select

Suction 1 Summary Suction

Name	Value
Name	Pack 1
Suction Optimization	No
Suction I.D	Suction
User File	None
Evap shutdown when injection off	No
* Main switch	OFF
* Cap. control mode	0: MAN
* Manual capacity %	0 %
* Po Reference mode	0:Ref+NiteOffset
* Po Setpoint	-112.0 'F
* ++Zone delay s	0 sec
* +Zone delay s	0 sec
* +Zone band K	0.2 'F
* Neutral zone K	0.0 'F
* -Zone band K	0.2 'F
* -Zone delay s	0 sec
* --Zone delay s	0 sec
* Kp Po	0.1

Controller menu selection. Use this drop down list to access the different controller menus.

Controller parameters, to modify or change double click line and press the enter key. The new value will be sent to the controller*

*Controller must be online
 *Some controller types require the main switch (R12 parameter) to be off before certain changes can be made

i When to use Upload / Download function:

The AK-SM holds a database in which all the system configuration is held. This includes any actual controller devices connected or just devices that have been selected ready for configuration. It is important to recognise when to perform an upload or download function so that any preset configuration is not overwritten by automatic upload by the AK-SM.

Upload

This function may be required where the case and pack controllers have already been configured and all parameters are set according to customer specifications. In this instance the need is to typically perform an upload function, thus updating the AK-SM database to fully reflect the controllers commissioned settings. Once this has been done, changes to the controller settings can be done directly from the AK-SM.

Download

The opposite to this would be where the controller devices have not been set per customer specification and the AK-SM should be used as the commissioning tool or window into the controllers. By navigating through all the controller screens in the AK-SM it is possible to configure the controller parameters and then send these setting to the connected controllers via the download function.

Copy function

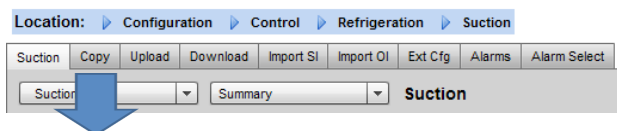

To aid the commissioning process, the AK-SM offers a settings copy function which can be used to copy one device settings and alarm configuration to other (similar) device(s). This function works when copying settings to and from same controller version / type devices. The procedure described below is one example of the copy /paste function.

Use the Copy tab to open the copy page, where any same controller type devices can be copied to. The actual device page will act as the copy base, so ensure the correct circuit is selected (in the drop down list). Select **all** or **individual** controllers that will be copied to, then press the copy to line.

- i** The copy function copies controller parameters etc from once device to the AK-SM database, to complete the operation the (copied) settings need to be **downloaded** to the required controllers.

The Global download function can be seen under the Network Nodes -> Download section

Import SI | OI function

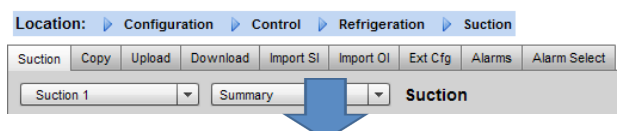

Use the **Import SI (Sensor Input)** and **Import OI (On/Iff)** function to gain access to 'generic' controller (Evap & Pack) parameters that are normally not accessible for alarm / logging / Boolean use. This function can be used to alarm on specific parameters not in the factory alarm list and / or can be used to import controller parameters in the Boolean logic calculator. Up to sixteen points can be selected per controller. This function extends the flexibility of controller support in the AK-SM and opens up the generic controllers parameter list for more customer specific needs. The following steps highlight the procedure in 'Importing'

From the import page(s) double click an import line to present a pop up box that shows all available parameters. Select the parameter that you wish to 'import' from the controller (you may give it a custom name).

In the example below, the parameter Po Setpoint has been selected. This parameter can now be seen in the miscellaneous calculator.

Name	Value
Import #1	001:1 Po Setpoint
Name	001:1 Po Setpoi
Type	Temperature
Import #2	Not configured
Import #3	Not configured
Import #4	Not configured
Import #5	Not configured
Import #6	Not configured
Import #7	Not configured
Import #8	Not configured
Import #9	Not configured

Important note:

Dependent on the load of the system it can take up to a minute, before the imported value can be used in e.g. a calculation for further use.

If the import of a value is basis for a secure operation we strongly recommend to find other ways to secure the system.

Extended Config function

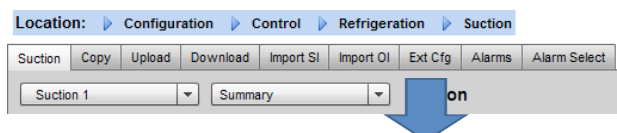

Extended configuration (changing what parameter is seen in the System View, Dashboard & Device detail status)

Using the extended configuration tab the factory standard parameter that is used for 'System View' status can be changed. This feature is useful in giving the end user more flexibility in showing the relevant sensor at the system and device detail views. By changing the **overview value** the AK-SM will then display the new selected parameter or status in the system view, Dashboard and device detail pages.

Alarms and Alarm Select

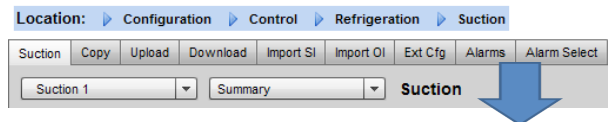

Use the Alarm tab to define the alarm actions associated with this device. Use the Alarm select tab to select up to 300 alarm points (max 300 per AK-PC controller)

Configuration -> HISTORY

The AK-SM history section allows the collection and recording of control parameters, values and status. The central history function allows up to 600 'points' to be configured, a point being a temperature, pressure, status, relay, etc. The collection of history allows further analysis using the AK-SM or remote web browser, where a graphical representation of this data can be made.

To configure history, navigate to the Setup tab (Configuration->History). The following setup lines are visible;

Auto Configure History: Use this function to auto select typical points needed for logging (the AK-SM will select key points in the Refrigeration, HVAC, Lighting and Misc control areas. Manual configuration can be done to override these selections or add more as required.

Clear History Configuration: Use this function to clear history configuration (points selected for history & the frequency of samples)

Clear History log: Use this function to clear stored history in the AK-SM

Start / Suspend History: Once the relevant points have been selected for history collection (using either the Auto history, manual or a combination of both) press this line to Start the collection. Press again to Stop collection

Status: Displays the current status of history collection (Collecting or Suspended)

No of Configured datapoints: Displays the number of configured history points (max 600)

Warning !

A change of the log interval will delete all previous logs of that chosen data point.



Note: Ensure the correct time & date are set in the AK-SM. Make sure the history collection function is running to ensure the collection of datapoints. Use the '**Start History**' line and check that the status reflects '**Collecting**'. When assigning history points to a controller device a recommended max of 45 points per device is allowed. Assigning more than 45 points per device will cause points not to record log history

Location: Configuration > History	
Setup	
Name	Value
Auto Configure History	
Clear History Configuration	
Clear History Log	
Start History	
Status	
No. of Configured Datapoints	11
Generic	8
Sensor Inputs	1
On/Off Inputs	0
Relay Outputs	0
Variable Outputs	0
Utility Meter	0
VLT	0
Other Datapoints	2

Auto Configure History

When selecting the auto configure history function the AK-SM presents the option to select the history collection sample rate.

These can be later changed & modified under the relevant history device type (Controllers/Relays/Sensors/On/Off/Variable/Other)

Configuration -> HISTORY

Controllers

If any controllers are configured for history collection, these can be seen in the **'Controllers'** tab. The example below shows a evaporator controller with the various control groups accessible via a drop down menu. Any auto history settings will be seen in these controller group lists, manual configuration of any parameter can be done in this page.

Location: Configuration > History

Setup | Controllers | Relays | Sensors | On/Off Inputs | Variable Outputs | Other

Pack 1 | All parameters | **Controllers**

Name	Value
100: --- Ctrl. state	01 Min
100: r12 Main Switch	Off
100: r28 SetPoint	01 Min
100: r29 Ref	Off
100: r30 RefMax	Off
100: r31 RefMin	Off
100: r32 Adjust Pc	Off
100: r33 Ctrl. mode	Off
100: r56 Min tm K	Off
100: --- Req. Cap %	01 Min
100: r64 Heat SP	Off
100: r65 Ref.Ramp K/m	Off
100: r68 ExtRefMax	Off
100: r69 ExtRefMin	Off
100: r72 Adjust S7	Off

Navigate and select appropriate points for history collection, via the drop down menu selector. Double click a required line, a pop up selection box allows the choice of sample rates; **1,2,10,30 mins**
1 Hr

Relays, Sensors, On/Off Inputs, Variable Outputs & Other

Depending on the defined control criteria, other points may be viewed and modified under the respective tabs.

Service Tool Support

Your AK-SM supports the Danfoss Service Tool (version 3.23 and higher). The Service Tool (CT) must be connected via an IP interface. Once an connection is established the ST will show the AK-SM and all AK2 platform devices. Note that non AK2 platform based devices will not show up in the ST device list.

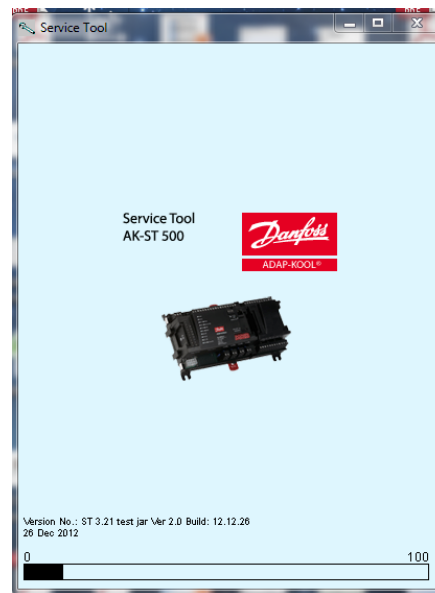

When creating a new connection in your ST make sure you select TCP/IP channel.

Assuming the factory default user name and password, enter **Supervisor** for the Destination name **12345** for the Pass code

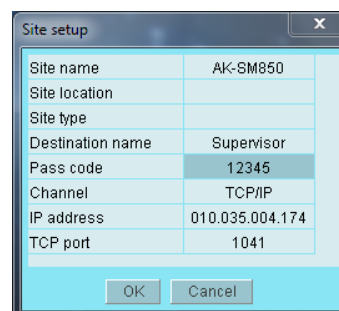

Once connected, navigate to your required controller in the available list. Access to all AK2 parameters is available via this connection.

Master Control Functions

(Energy saving features, scheduling and load shedding configuration)

This section will discuss rail heat control, schedules, HVAC, and lighting. Please refer to this section when configuring more advanced areas of your AK-SM.

Rail Heat

The AK-SM can be used to manage the energy output to the case trim heaters (Rail Heat). There are different ways to approach the solution to rail heat control, listed below are three main possibilities.

1 - Use a Night Setback Schedule

Many Danfoss controls have a function whereby the output to the rail heat elements can be pulsed in a percentage of time ratio. If set in the controller, the night setback signal from the AK-SM will allow the controller to vary the output depending on the time period. Consult specific controller manual for more details

2 - Use AK I/O relays to control rail heater connections (using 'Calculated' or physical Dew point)

By means of utilizing temperature and relative humidity sensors the AK-SM can calculate the relative Dew point. Based on this Dew point reference and against a set point the output to the rail heat elements can be controlled. This represents 'tighter' control based on the calculated Dew point.

3 - Use Adaptive Rail heat control

Adaptive rail heat is a feature that groups together a collection of compatible evaporator controllers that receive signals of the current calculated dew point from an installed dew point / temperature sensor. The installed humidity / temperature sensor connects to the AK-SM (via I/O) and the resulting calculated dew point value is sent to the connected evaporator controllers

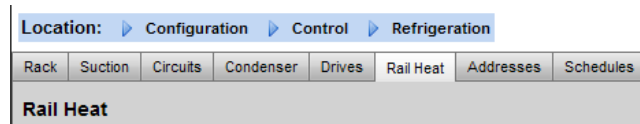

From the Control screen navigate to Refrigeration then Rail Heat (Configuration->Refrigeration->Rail Heat)

AK I/O relay method

Select 'No' to the question line 'Use Adaptive Rail heat'

Define how many relays will be used in the control of the rail heat elements (max 30).

Cycle time - Used to determine what amount of time the relays are energized, used in combination with the output percentage as set in the Dew point setpoint.

Dewpoint method

- Calculated dewpoint (Using a combined temperature / humidity sensor - type: EMHS3-1 is recommended. See below for wiring example)
- Dewpoint (Utilize direct output from dewpoint sensor)

Selecting Use HVAC humidity to "yes" Rail heat dew point will be calculated using Rail Temp and Inside RH sensor inputs. A Rail hum point will not be generated by the SM800.

Selecting Use HVAC humidity to "no" Rail heat dew point will be calculated using Rail Temp and Rail hum sensor inputs.

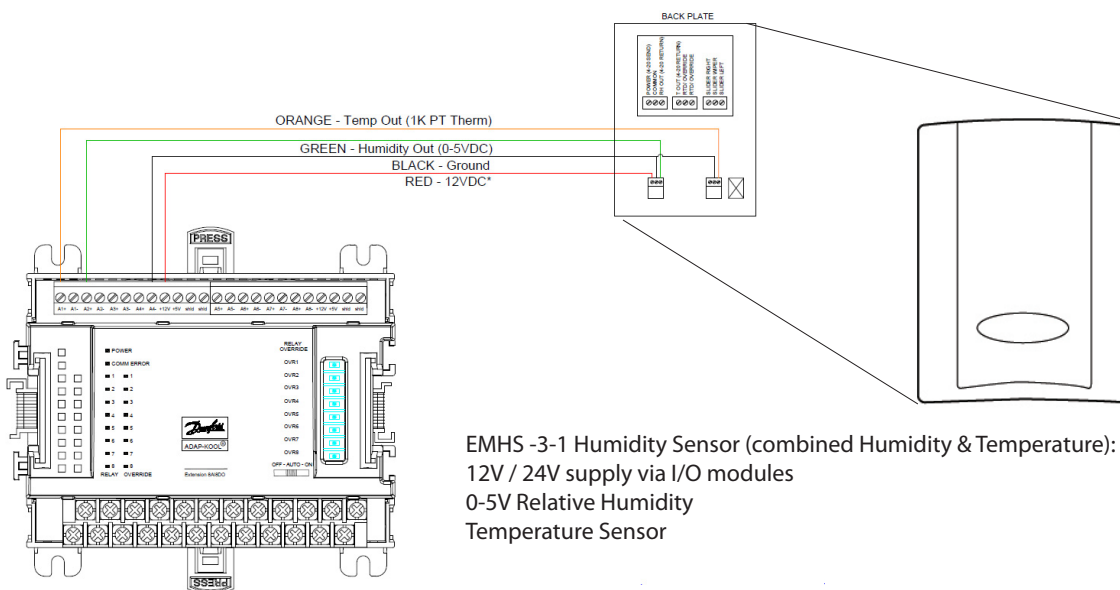

EMHS -3-1 Humidity Sensor (combined Humidity & Temperature):
 12V / 24V supply via I/O modules
 0-5V Relative Humidity
 Temperature Sensor

Location: Configuration Control Refrigeration	
Rack Suction Circuits Condenser Drives Rail Heat Addresses Schedules	
Rail Heat	
Name	Value
Use adaptive rail heat	No
Number of relays	1
Cycle Time	1 min
Dewpoint method	Calc Dewpt
Use HVAC humidity	No
Rail Heat 1 Dewpoint >	8.0 °C
Rail Heat 1 Dewpoint <	-4.0 °C
Duty Cycle >	100 %
Duty Cycle <	0 %

Example: With a Dew point target range of -4.0 to 8.0°C and the Cycle time set for 10 minutes the following behavior will be true.

- At -4.0°C Dewpoint the relay output will be 0%
- At 8.0°C Dewpoint the relay output will be 100%
- At 2.0°C Dewpoint the relay output will be 50% of the cycle time (5 mins on, 5 mins off)
- At 7.0°C Dewpoint the relay output will be 90% of the cycle time (9 mins on, 1 min off)

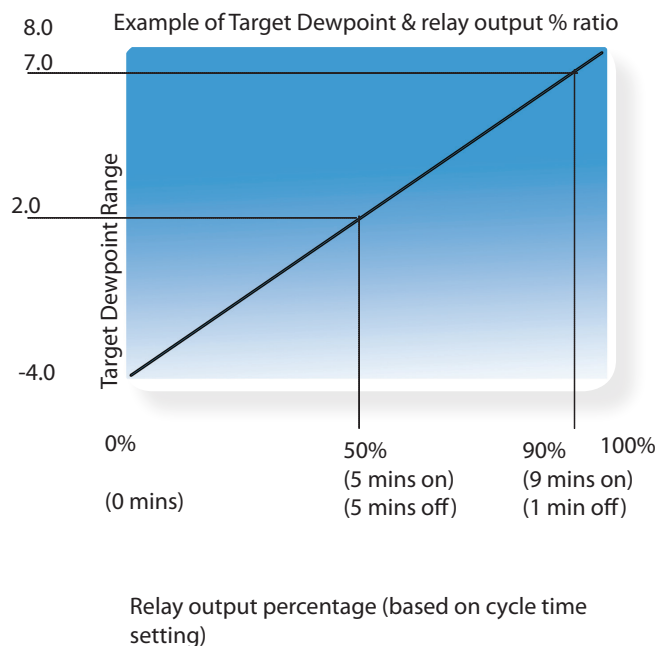

Adaptive method (with compatible Danfoss evaporator controllers)

Adaptive rail heat is a feature that groups together a collection of compatible evaporator controllers that receive signals of the current calculated dew point from an installed dew point / temperature sensor. The installed humidity / temperature sensor connects to the AK-SM (via I/O) and the resulting calculated dew point value is sent to the connected evaporator controllers. By controlling rail heat according to the actual dew point measured in the store, significant energy savings can be achieved. The following section highlights how to configure active rail heat via the Danfoss AK-CC 550 evaporator controller (which has the ability to utilize calculated dew point over the communications bus).

Select 'Yes' to the question line 'Use Adaptive Rail heat', and (in this example) select 'Calculated Dewpoint' as the dewpoint method. Upon answering these questions the AK-SM will automatically build sensor points to allow for the humidity and temperature sensors to be defined. As the diagram below shows, the EMHS3-1 sensor has humidity and temperature wired in to an AK I/O module, the points at which these sensors are connected can then be added under the sensor page (Configuration->Control->Refrigeration-Addresses)

Name	Address	Type	Value
Inside Temp	00-0.0	PT1000	Inside Temp
Outside Temp	00-0.0	PT1000	Outside Temp
Inside RH 1	00-0.0	EMHS3-1	Inside RH 1
Ra11 Hum	00-0.0	EMHS3-1	Ra11 Hum
Ra11 Temp	00-0.0	PT1000	Ra11 Temp

When using the EMHS3-1 sensor the humidity & temperature output will be connected to AK I/O. Use the 'Addresses' tab to locate the sensor sub-tab, where the appropriate board & point can be set (in line with the physical connections on the AK I/O)

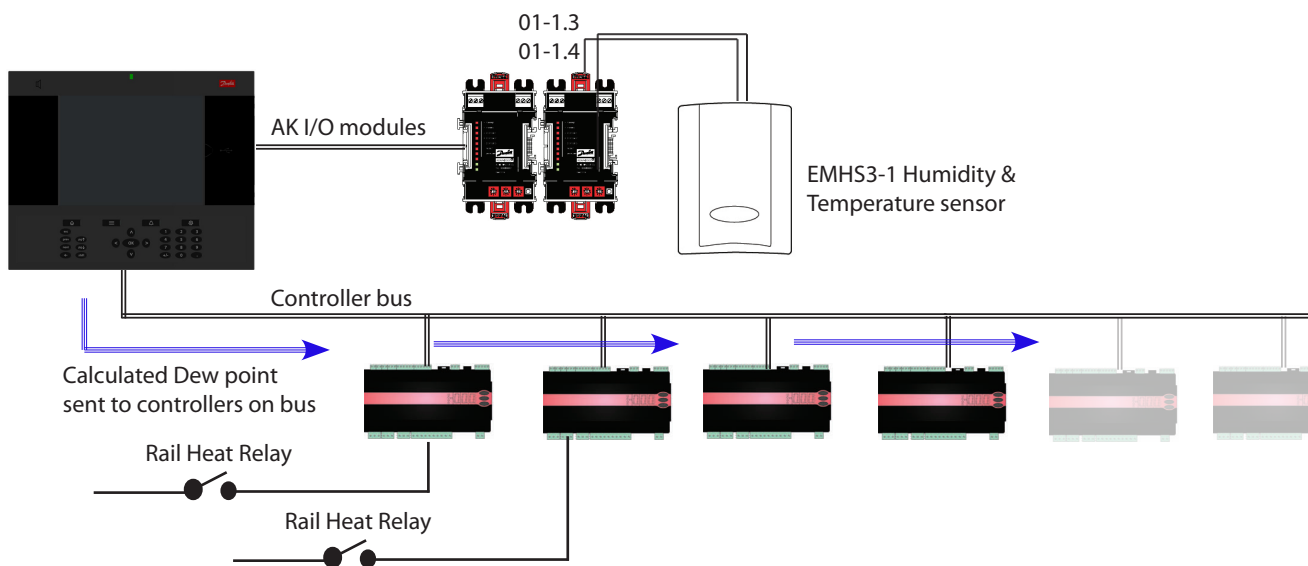

For adaptive rail heat to function correctly ensure the AK-CC 550 controllers are set correctly. Review parameters o85, o86 and o87, as noted below. The screen image below highlights the AK-CC 550 controller (Miscellaneous menu), where parameter o85, o86 and o87 are set for rail heat control over the bus.

Name	Value
* #12 Main switch	0-Stop
* o61 Appl.mode	Application 8
* o38 Light config	2-Data communica
* o39 Light remote	0-Off
* o46 Case clean	0-normal op
* o85 RailTh_mode	0-Not used
* o41 RailTh.ONduty	100 %
* o42 RailTh.ONduty%	100 %
* o43 RailTh.cycle	10 min
* o86 DewP Min Lim	8.0 °C
* o87 DewP Max Lim	17.0 °C
* o88 Rail Min ON%	30 %
* o89 Door-InstStart	30 min
* o06 SensorConfig	0-P11000
* r05 Temp.unit	C
* r09 Adjust 54	0.0 °K
* r10 Adjust 53	0.0 °K
* r59 Adjust 56	0.0 °K
* o01 Defrost/Defog	3 sec
* o02 D12 Config	0-Not used
* o37 D12 Config	0-Not used
* o84 D13 Config	0-Not used
* o92 Displ menu 2	Def Stop Temp
* o97 Displ. Ctr1	1
* o88 Light MS-Off	0
* o05 Acc. code	0
* o84 Acc.code 2	0

Rail heat settings in the AK-CC550

o85 = Rail heat control (select option 2, pulse control with dew point function)

o86 = Dew Point MIN limit

o87 = Dew point Max limit

At a dew point which is equal to or lower than the value in O86, the effect will be the value indicated in o88. In the area between the two dew point values the controller will manage the power to the rail heat

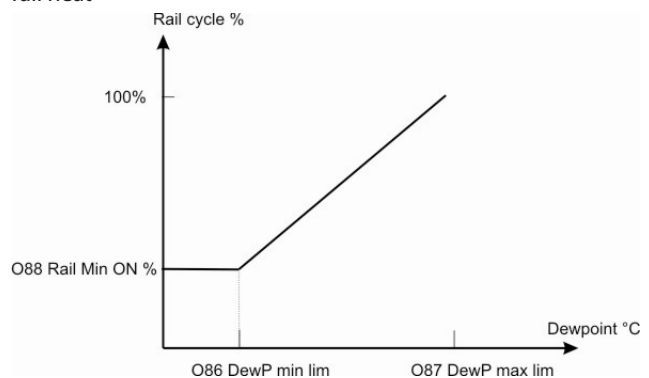

Schedules

(used in combination with Danfoss controllers)

Configuration->Control->Refrigeration->Schedules

Under the schedules section multiple schedules can be added and configured according to your needs.

Enter the number of schedules required. The desired number of schedules will be shown (in this example 3 schedules have been requested). Initially each new schedule is set to disabled, move the cursor to the required schedule line and press 'Enter'. The resulting page allows the definition of the schedule, the following configuration settings can be made;

- Enable this schedule (ensure this is set to 'YES' to engage schedule)
- Schedule usage (Choose from Case Lighting, Night Setback, Shutdown, Defrost, Coord Defrost)
- Description (Add custom description for schedule)
- Schedule control (Choose between Time, Digital, Time & Digital, Time or Digital)
- Number of schedules (select the number of sub schedules required)
- Start, Stop, Days and Holidays (Define the Start / Stop times, days and holidays)

Name	Value
Make a selection	
Press to enable all	
Press to disable all	
Num of schedules	5
Case Lighting	Disabled
Night Setback	Disabled
Defrost	Disabled
Schedule 4	Disabled
Schedule 5	Disabled

Name	Value
Enable this schedule	No
Schedule usage	Case Lighting
Description	Case Lighting
Schedule control	Time
Num of schedules	1
Sched 1	
Start	04:00 AM
Stop	12:00 AM
Days	SMTWRFSA
Holidays	12345678

Each schedule line will also reflect the current status

False = schedule not active

True = schedule is active

Disabled = Not Active (Enable in schedule setup page)

The example screen below highlights the different areas of schedule configuration, in this example the [Case Lights] schedule has been set to start at 04:00AM until 01:00AM based on Time [AK-SM time] **or** a Digital Input. For this example the Digital Input had already been defined under the Miscellaneous ON/OFF section, using AK I/O input **01-1.1**. The schedule will now become true (ON) if either the Digital switch is made **OR** the Time falls between the set Start / Stop times.

The example also has active schedule days seen as -MTWRFA. Sunday (S) has been deselected (-) therefore the schedule is only relevant Monday -> Saturday. I.E. S= Sunday, M=Monday, T=Tuesday, W=Wednesday, R=Thursday, F=Friday, A=Saturday.

After the schedule has been created the associated circuit [Evap] controllers must be selected - do this via the **Controllers** tab.



Note: A start / stop time of 12:00AM - 12:00AM = always ON

To associate controllers with the schedule, use the Controllers tab

Location: Configuration > Control > Refrigeration > Schedules	
Schedules Controllers	
Case Lighting Schedules	
Name	Value
Enable this schedule	No
Schedule usage	Case Lighting
Description	Case Lighting
Schedule control	Time or Digital
Digital input	01-1.2 Schedule Input
Num of schedules	1
Sched 1	
Start	04:30 AM
Stop	01:00 AM
Days	-MTWRFA
Holidays	12345678

Use drop down box to select other schedules or use 'Prev' 'Next' keys on the local key pad

Set to YES to enable schedule

Press the enter key to select the pre-defined ON/OFF input

Navigate to the **Controllers** tab and any configured evaporator controllers will be listed (if no controllers are listed make sure the appropriate controller type is set, as defined in the main control page). Navigate to the required controller and double click the relevant line. This will toggle the controller 'Selected' or 'Not Selected'. Any controller set as 'Selected' will become part of the schedule.

Once all configuration of the schedule is complete, navigate back to the Schedules tab & select 'Enable this schedule' to YES

Location: Configuration > Control > Refrigeration > Schedules	
Schedules Controllers	
Case lighting Controllers	
Name	Value
Make a selection	
Press to select all	
Press to deselect all	
Circuit AA1	Selected
Circuit AA2	Selected
Circuit AA3	Not selected
Circuit AA4	Selected
Circuit AA5	Not selected
Circuit AA6	Not selected
Circuit AA7	Not selected
Circuit AA8	Selected
Circuit AA9	Not selected
Circuit AA10	Not selected

Use the 'Enter' key to select or not select any controller(s).

Schedules manual override













For test or commissioning purpose or use of groups outside of the programmed interval it's possible to override the schedule.

In case this feature is needed, go to configuration -> control – refrigeration -> schedules and double click in the selected schedule on the line "Press to turn on"

The status is changing from Auto to manual on.

Note: It is not possible to turn off and the feature is only available for defrost and not for setback, shutdown or other features.

Location: Configuration Control Refrigeration

Rack	Suction	Circuits	Condenser	Drives	Rail Heat	Addresses	Schedules
Make a selection							
 Press to enable all							
 Press to disable all							
 Num of schedules 7							
 misc test Disabled							
 550 Defrost 03/16/16 01:02							
Group defrost Auto							
 Press to turn on							
 750 defrost 03/16/16 02:02							
Group defrost Auto							
 Press to turn on							
 114 defrost True							
 1st 10 for defrost 03/14/16 17:02							
Group defrost Auto							
 Press to turn on							
 Shutdown test True							
 Misc test True							

Suction Pressure Optimization

The Adaptive Suction Pressure function in your AK-SM makes it possible to automatically optimize the suction pressure so that it will be adapted to the systems actual load. During optimization, data is collected that tells the system which refrigeration appliances are most heavily loaded. This energy saving function can make substantial savings directly whilst also saving on compressor wear and tear and also providing an analysis tool for refrigeration appliances.

The individual controllers handle the temperature control in the refrigeration appliances. The load and operating conditions of each are continuously collected by the AK-SM via the data communication system. The collected data is computed and the "most heavily loaded" refrigeration points are identified. An adaptation can now be made of the Suction Pressure, whilst ensuring the air temperature at the refrigeration appliance is maintained. It is the AK-SM that collects data from the refrigeration appliances and it is the AK-SM that transmits any offset to the compressor pack control so that suction pressure reference is changed to suit the needs of the "most heavily loaded" refrigeration point. **It is always the temperature at the appliance that takes top priority** and in fact the suction pressure can float down if necessary. The time during which a refrigeration point has been designated "the most heavily loaded" will be summed up in the log (history) within the AK-SM.

The pack suction (P_o) pressure is optimized in accordance with the current refrigeration demand, taking into account short-term changes (day/night setback/defrost) and long-term effects (seasonal/weather changes).

In order to get the best efficiency out of the Po Optimization function it is highly recommended that a plant survey is done before enabling this function. A poorly running site will not be corrected by Po Optimization and the maximum benefits will not be seen - ensure all plant & evaporator cases are running close to their designed setpoints and that defrost are operating correctly. Also ensure any manual plant override systems are set accordingly to allow the floating up of suction pressure.

Theory of operation

The Po Optimize function uses a calculation on all controllers to determine a "Load Factor". This has been developed by Danfoss and is available in your AK-SM. By use of the Load Factor the Most Loaded Case (MLC) is constantly updated. Floating of the Suction Setpoint is then determined at any given time by the MLC

- 1/ The AK-SM continuously receives operating information from each (Po enabled) controller connected on the network. The AK-SM is looking for the 'Most loaded case' (MLC). Each evaporator is analyzed to see if its current operating temperature is within a calculated MLC 'target window'. During defrost and including after defrost recovery, the Po Optimization will temporarily remove the case from the Po calculation loop. This ensures that normal system fluctuations (due to defrost etc) do not effect the overall operation of Po Optimization.
- 2/ In effect the continuous Po Optimization is looking for the evaporator that is under the heaviest load (the one that has to work the hardest to maintain temperature), but still falls within the MLC target 'window'
- 3/ Based on the MLC the Po optimization function will then send a control signal to the Pack controller to optimize the running suction pressure, i.e. float the pressure up (based on the max limit set in the Pack configuration page). As the Pack controller allows the suction pressure to increase the AK-SM monitors the complete network and ensures that the refrigerating system as a whole is stable. This then is a continuous function that once set runs automatically and ensures the refrigeration system is running to the best conditions.

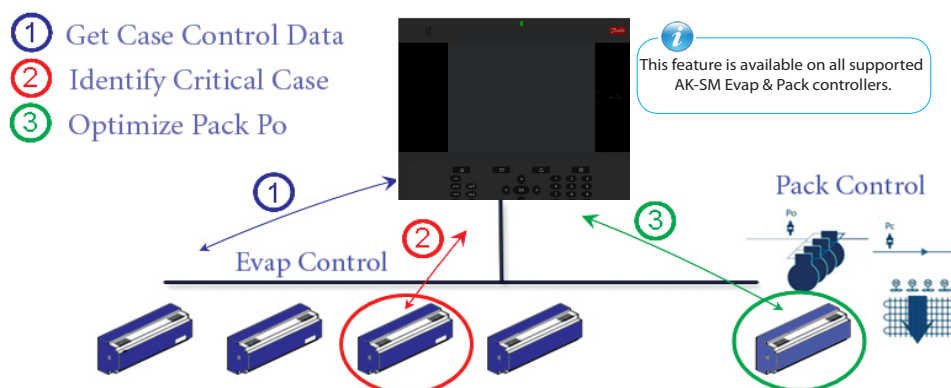

Configuration of suction optimization

Assuming a pack and evaporator suction group has already been defined, go to the Pack controller configuration screen. Locate the line 'suction optimization' and set to 'yes'.

Settings	
Name	Value
Name	Centr Koelinst
Suction Optimization	Yes
Suction I.D	Centr Koel
Max float	0.0°K
Allow float below target	No
Post defrost delay	30 min
Stop suction optimization when	
Number of case controllers offline	2
Post delay	15 min
Offlines No Float alarm	Normal
Action	1
User file	None
Evap shutdown when injection off	No

Enable suction optimization by selecting 'Yes'. All evap controllers associated with the Pack will then be tagged 'yes'.

This automatically sets all evaporators associated with this suction group to also operate in Po optimization mode. If required, individual evaporator devices can be manually removed from the optimization loop under the individual evaporator configuration screens.

- Set an appropriate Maximum float pressure (shown in 'k') change that the optimization algorithm can make to the pack controller.
- Enter a post defrost delay (The time period that the Po Optimization algorithm ignores the evaporator device after a defrost. This allows the evaporator to recover from a defrost without effecting the Po Optimization algorithm).
- Define Po stop and alarm conditions (if x controllers enter off line state, then stop optimization)

It is possible to remove any evap controller in the optimization function by selecting 'No' in the (evap) device detail (settings) screen.

Evap device detail (settings)	
Name	Value
Name	Groente TD 300
Suction Optimization	Yes
User file	None
Evap shutdown when injection off	Yes

Once set, the Po optimization operation can be seen under the pack controller screen (optimization tab)- refer to (local screen) examples below.

Optimization	
Name	Value
View	Today
Status	Float based on Rund ZB5 200
Adjust suction by	0.0°K
Float up-all OK	0.0%
>Rund ZB5 200	15.7%
Varken ZB5 200	14.0%
Feest ZB5 300	9.9%
Borre1 ZB5 300	8.4%
Vleesw Buffet	8.1%
Zuivel TD 300	7.3%
Vis ZB5 200	4.2%
Vis ZB5 200	3.5%
Vleesw TD 200	3.5%
Kaas TD 200	3.3%
Zuivel TD 200	2.7%
Kaas Trevi 200	2.5%
Zuivel TS 200	2.4%
Kant&K1r TD 300	2.2%
Grill Trevi 200	1.7%
Zuivel TD 200	1.5%
Vleesw TD 200	1.4%
Groente TD 300	1.2%
...	...

i If your AK-SM is configured for degrees C, Suction Optimization is "K".
If set to degrees F Suction Optimization is "F".

AKC ON (Evap shutdown when injection off)

One of the main features of the AKC On function is that the SM will detect if there is a pack shutdown condition. The SM does this by monitoring the pack controller for such conditions. If configured to do so, and upon detecting a pack shut down, the SM will issue a signal to all (configured) evap controllers under the pack suction group to close their AKV valves. The effect of closing the local AKV valve is to limit liquid flow in the evaporator. Due to the AKV valve being closed during a pack shutdown period there is a greatly reduced risk of liquid hammer or compressor damage upon pack / compressor start up. The AKC ON function must be configured for each pack suction group. By default, the associated evap controllers are set to 'yes' under the selection choice of Evap shutdown when injection off. If a evap controller is not required to be part of the suction group AKC ON function, set this value to 'No'.

Settings	
Name	Value
Name	Centr Koelinst
Suction Optimization	Yes
Suction I.D	Centr Koel
Max Float	0.0°K
Allow Float below target	No
Post defrost delay	30 min
Stop suction optimization when	
Number of case controllers offline	2
Post delay	15 min
Offlines No Float alarm	Normal
Action	1
User file	None
Evap shutdown when injection off	No

Pack Configuration

Under the settings / Summary screen set the question Evap shutdown when injection off to 'YES'

AKC injection ON

For commissioning, retrofit and filter change mode it is necessary to simulate the signal from pack controller. Means, close valves manually.

In case the menu "Evap shutdown when injection off" a new menu appears in manual operation section, which enables the user to select between injection ON, OFF and AUTO mode.

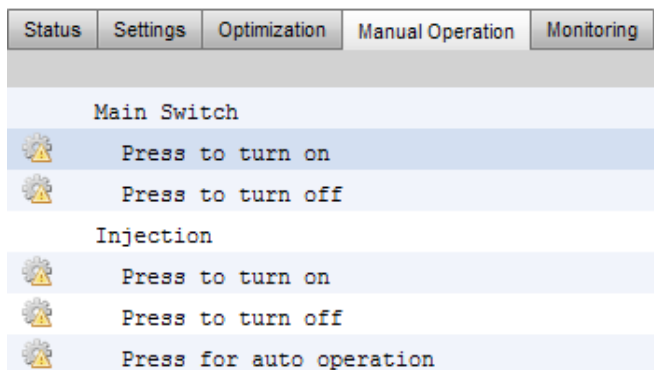

Evap Configuration

If the Evap is not required to be part of the AKC ON function, modify the question
Evap shutdown when injection off to 'No'

Status Settings Manual Operation	
Summary Settings	
Name	Value
Name	Groette TD 300
Suction Optimization	Yes
User File	None
Evap shutdown when injection off	Yes

Note:

Make sure that the Pack controller has the field Ctrl. Of Injection ON set to Network, for AK2 style devices you may need the Danfoss Service Tool in order to see this parameter

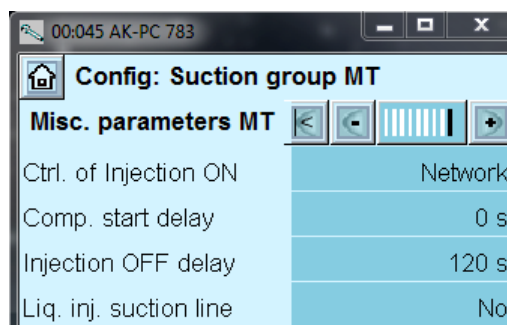

Danfoss AKC Support (Via AK-PI 200)

The following section describes the configuration of the Protocol Interface -200 (PI-200) in the System Manager. For detailed PI-200 installation instructions and please refer to the PI-200 manual (RS8EX202). The AK-PI 200 is a network device allowing legacy AKC and AKL type controllers to be operated via your System Manager. Any connected DANBUSS controller will be presented similarly to other refrigeration controllers (i.e. LON RS 485 / MOD-BUS devices).

Important limitations

Up to 60 AKC controllers can be connected to a single AK-PI 200. If there are more than 60 controllers, two AK-PI 200 units must be used. Up to four AK-PI 200 units can be connected to a single System Manager.

The link between the System Manager and the AK-PI 200 is via a TCP/IP. Ensure when connecting your AK-PI200 to the network be sure to use a router or switch, not a network hub. The AK-PI 200 will not function correctly if network hubs are used.

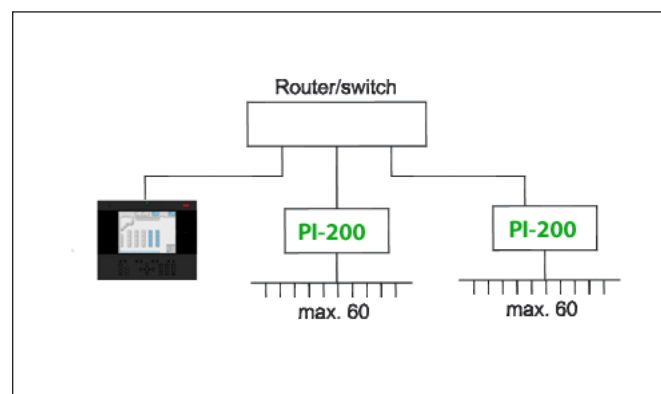

Preparation / Addressing

Both the System Manager and the AK-PI 200 must have valid addressing set before any configuration can take place. Consider the following steps when setting up your System Manager and PI-200.

1. Ensure System Manager has a valid IP address and is connected on the LAN.
2. Use AK-Service Tool and make direct connection to the PI-200, under IP setup check correct IP address mode (Dynamic/Static), Port Number (default 1041 in PI-200 and System Manager).
3. Set physical Danbuss address for PI-200 by using the rotary address switches on the PI-200. A unique address must be assigned for PI-200, with no duplicate with generic devices on any field bus.

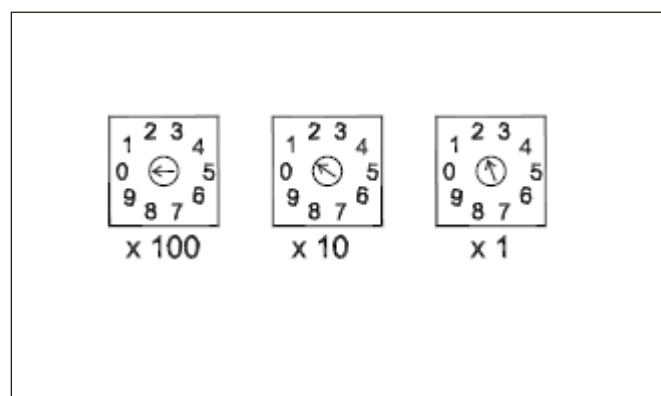

PI-200 configuration in System Manager (via web wizard)

The following text will describe the workflow when adding PI-200(s) to your System Manager, including scanning and mapping of AKC devices.

Note! Using the layout wizard assumes no other Refrigeration configuration has been previously performed. Using the wizard on a pre-existing configuration may result in loss of configuration, use manual method described in this user guide.

Under the 'Configuration' tab, locate the Refrigeration 'Layout' wizard, and start the process, under the network screen select the PI-200 to enabled.

The next screen shows details of the PI-200. If multiple PI-200 units are installed you should select only the PI units which will be associated with the particular System manager.

Channel LONWORKS	Enabled
Channel MODBUS-RS485	Disabled
Channel SNMP	Disabled
Channel PI-200	Enabled
Port	1041

Make a selection			
Press to select all			
Press to deselect all			
Make a selection			Unlock
Addr	Model	IP Address	Select
151	080Z8521	10.35.36.5	Selected
153	080Z8521	10.35.36.127	Selected

Follow the remaining wizard screens to format device names and map case to pack controls to form suction 'groups'.

PI-200 configuration in System Manager (via manual configuration)

If there are existing devices already on your System Manager you may want to manually add the PI-200 / AKC via the manual method. This section covers how to scan PI-200 and configure the AKC nodes.

1. Via the Configuration ->Network Nodes tab, select Channel PI-200 (checking correct port address, as previously described)
2. Initiate a network scan by selecting the 'Press for complete rescan' line entry
3. Under the Scan Status tab navigate to the PI-200 sub tab, here any detected PI-200 units will be shown and can be selected for use with the System Manager.
4. Under the 'PI-200 Status' sub tab you can view the address, version, status, signal quality and number of devices under each PI-200.
5. Once the above process is complete the next step is to define the number of devices you wish to add to the System Manager. Under the Configuration -> Control tab enter 'Number of racks/packs' and select the relevant Pack controller. Tip! Use the 'show only scanned devices' line to only show only the controllers that the System Manager has previously scanned, this will reduce the list of available devices to select from.
6. Navigate to the Refrigeration -> Circuits tab to set which case type is to be used

The remaining configuration tasks are already described earlier sections of this user guide.

Location: Configuration > Network Nodes

Node Overview	Points	Scan Status	Config Status	Duplicates	Upload	Download
Node Overview						
Name	Value					
Channel LONWORKS	Enabled					
Channel MODBUS-RS485	Disabled					
Channel SNMP	Disabled					
Channel PI-200	Enabled					
Port	1041					
Press for complete rescan						
Last scan	05/30/13 02:21 PM					
	Disabled					
	Enabled					
Nodes scanned on network	113					
Nodes configured in database	107					
Node Type	Configured	Scanned				
O18 Board	0	0				
R08 Board	0	0				
S18 Board	0	0				
V02 Board	0	0				
Utility Meter	0	0				
Light Panel	0	0				
Generic	107	112				
AK-CM	0	1				
Calculations	0	N/A				

Location: Configuration > Network Nodes > Scan Status

All Nodes	Controllers	IO Boards	Other Nodes	PI-200	PI-200 Status
PI-200					
Name	Value				
Make a selection					
Press to select all					
Press to deselect all					
Make a selection	Unlock				
Addr	Model	IP Address			Select
151	080Z8521	10.35.36.5			Selected
153	080Z8521	10.35.36.127			Selected

Presentation of the AKC devices

Once connected to the PI-200 and configured, the AKC devices will be represented in the same format as any other refrigeration device. The AKC devices will be shown in the main screen dashboard under Refrigeration. Selecting a device will then show the device detail screen, where (if authorized) the user can view and make setpoint changes.

Note! The response times over a Danbuss network and via the PI-200 is somewhat slower than traditional LonWorks networking, any delay in retrieving data is not an indication of system fault, but due to Danbuss network performance.

Monitoring Points

Your AK-SM offers a simple yet effective way to display temperature sensors that also include dedicated alarming and inhibiting functions. The following section describes the configuration of monitoring points and their associated functions.

Adding monitoring points manually

From the Configuration -> Control menu select the required amount of circuits, then navigate to the Refrigeration -> Circuits page and under type, select 'Monitoring'. The selection of 'Monitoring' in the drop down selection list offers the user a means to capture, record and display sensors and to present them in the 'Misc' section of the home dashboard screen. This method of sensor input is in addition to the miscellaneous sensor inputs used elsewhere in the AK-SM system and can be used to monitor board & point inputs or sensors from connected network controllers (i.e. AKC, AK2, EKC).

Once set to Monitoring navigate to the Setup tab, using the drop down menu to select the recently defined monitoring points.

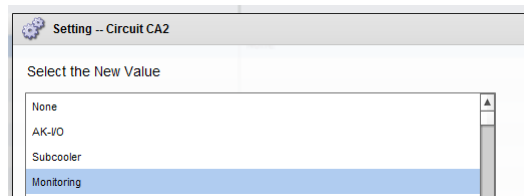

Location: Configuration > Control > Refrigeration > Circuits

Type	Setup	Alarms	Copy
Monitoring 3-1	Setup		
Name	Value		
Monitor temp input	Yes		
Monitor defrost input	Yes		
Post defrost alarm delay	30 min		
Generate cleaning input	Yes		
Post clean alarm delay	15 min		
Monitor digital input	Yes		
Inputs			
Name	Monitoring 3-1		
Bd-Pt	00-0.0		
Broadcast	No		
Type	PT1000		
Name	Defrost 3-1		
Bd-Pt	00-0.0		
Broadcast	No		
Type	Voltage		
Name	Clean 3-1		
Bd-Pt	00-0.0		
Broadcast	No		
Type	Voltage		
Name	Digital 3-1		
Bd-Pt	00-0.0		
Broadcast	No		
Type	Voltage		

Location: Configuration > Control > Refrigeration > Circuits

Type	Setup	Alarms	Copy
Monitoring 3-1		Alarms	
Name	Value		
Low Temperature: Monitoring 3-1 00-0.0	Disabled		
High Temperature: Monitoring 3-1 00-0.0	Disabled		
Defrost input: Defrost 3-1 00-0.0	Disabled		
Monitor Input: Digital 3-1 00-0.0	Disabled		

To setup monitoring points follow the 'standard' method in refrigeration configuration - Main Menu / Configuration / Refrigeration / Add Controls. Answer 'No' to the question 'Pack controller required?' and navigate to the lower section of the screen and describe how many monitoring sensor points are required (still described as No of case controllers.?)

Click on the Setup button and then select the **Type** drop down list
Choose **Monitoring** from the drop down list

Monitor temp input

Select 'Yes' to allow monitoring of a board & point sensor or a sensor via a connected network controller

Defrost Input

If required a Defrost input can be configured. A Defrost input would be used to effectively inhibit the alarms whilst the equipment was in 'defrost mode'. Once a Defrost input has been configured it can be used in conjunction with further sensor setups (select Existing option for this)

No No Defrost input required

Yes Define Defrost input

Existing Pick from previously set Defrost inputs

Monitoring setup page

Monitor temp input

Select 'Yes' to allow monitoring of a board & point sensor or a sensor via a connected network controller

Post defrost alarm delay

Enter the required time delay that the AK-SC255 will apply after it has detected a defrost has completed - this can stop nuisance alarms

Generate Cleaning input

Select 'Yes' if a cleaning input is required (typical example could be voltage or switch). When the assigned switch is made the monitoring point will detect this change of state and will stop any alarms from being transmitted. After the cleaning input is re-set any future alarms will be transmitted - after any post clean alarm delay timer has elapsed.

Post clean alarm delay

Enter the required time delay that the AK-SC255 will apply after it has detected the cleaning input has reset

Monitor digital input

Select 'Yes' to allow monitoring of a digital input via a board & point input or a digital input via a connected network controller

Input configuration

After selecting 'Yes' to any of the questions in the upper part of the monitoring configuration screen the resulting input is shown below.

A custom name can be given to each input. For each input enter the corresponding board & point address for local I/O to enter a controller address (see next section for further details on entering controller address). Finally make sure the type is correctly defined for the input (via a drop down list). Page Down to define any alarms for the inputs. Continue to configure any remaining sensors, once complete you can view the sensors in the Evap Overview list, via the Main Menu. As in the generic format simply click on the sensor to view a summary screen. The detail page for the monitoring point contains current status & temperature, the ability to inhibit (stop alarm from occurring) and alarm settings (if configured).

Additional monitoring of dedicated HACCP sensors

Using the monitoring feature as previously described, dedicated HACCP sensors can be displayed in the main Dashboard overview screen and subsequently logged for history and alarm limits can be assigned.

Danfoss offers a dedicated HACCP sensor (AK-HS 1000) which is supported by some of the evaporator range of AK-CC controllers. In this example the AK-CC 550 evaporator controller will be used to highlight the required steps to monitor this dedicated HACCP sensor. In the example below an amount of (AK-CC 550) evaporator controllers have been defined and a corresponding amount of monitoring points also defined. Once in the monitoring point configuration screen select 'yes' to the question 'Monitor temp input'. Enter a suitable name for the sensor (Case 1 HACCP in this example) and add the relevant controller network address in the form of 001:1 is controller address 1, 002:1 is controller address2... The principle is that by adding the controllers address in the Bd-Pt box the parameters for that controller become available. The final step is to define the HACCP sensor connected to this AK-CC550 (parameter u56 in this example) -this is done via the drop down list against the Pt# line. Page down to set any alarms associated with this sensor and duplicate for the remaining monitoring points - using the relevant controller address to access the parameter list. The defined HACCP sensors will now be seen in the Evap overview screen and can also be set for history collection.

Miscellaneous Configuration

Configuration -> Control -> MISC

Location: Configuration Control

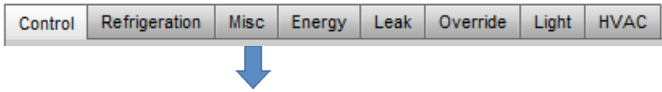

The term Miscellaneous refers to the ability to monitor and control miscellaneous areas of an application using Danfoss AK I/O (modules). For example, a miscellaneous relay output may be required for an exhaust fan, a dispenser that adds chemicals, an oven, a produce fogger, or any other device that can't or shouldn't be treated like an ordinary refrigeration, HVAC, or lighting asset. Miscellaneous on/off, sensor inputs can be used in defining the control strategy for miscellaneous relay outputs. Any miscellaneous points configured can be monitored for history, and may be configured strictly for that purpose, or for alarms. Routable alarms can be created for any Miscellaneous point. For sensor inputs, the AK-SM allows custom conversion for non-Danfoss sensors that have a linear response (known as Conversion factors)

The initial Miscellaneous definition is set out in the Configuration->Control page (see below). In addition to Relay, Sensor, On/Off Inputs and variable outputs the Misc section also has Conversion Factors & Calculations. Further details on conversion factors and calculations can be seen in this section.

Misc	
No. of relay outputs	1
No. of sensor inputs	20
No. of on/off inputs	0
No. of variable outputs	0

Configuration-Control screen

Once the required misc points have been set (number required), configuration is done under the **Misc** tab.

In this example a miscellaneous sensor has been configured, but the same principle will apply if configuring Relays, On/Off and variable outputs. Under the Misc tab, navigate to the sensors tab. Enter a suitable description for the sensor, then under the Bd-Pt line, enter the board & point address for the sensor in question. In this example the address 01-1.2 has been assigned. Review the remaining items in the list and configure according to your site requirements.

Name	Value
Name	Bakery Oven tmp
Bd-Pt	01-1.2
Broadcast	No
Type	PT1000
Number of alarms	0
Sensor fail alarms	Disabled

for this example the board and point address 01-1.2 is assigned

Example of I/O module line up. The communication module (AK CM 101A) has an address set as 1, with module 1 having the sensor in location 2. This is then entered in the AK-SM as 01-1.2

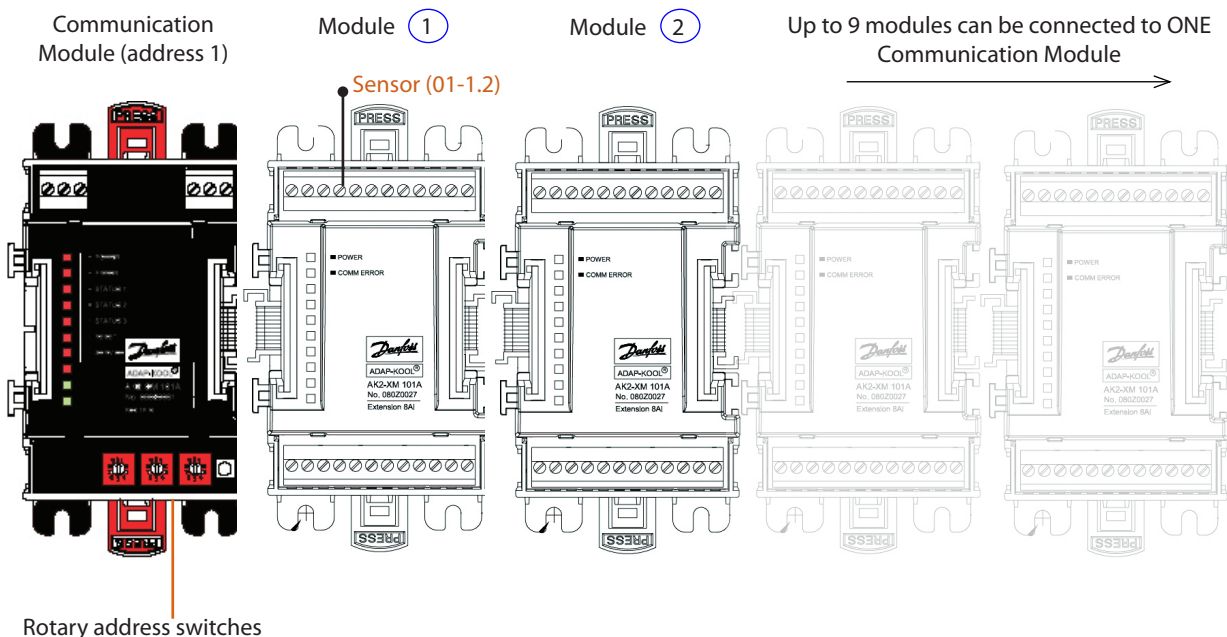

Relays Tab

The example below shows the Misc Relays tab. Navigate down the control lines and configure as required.

Example of Misc Relays Tab

Name	Value
Name	Relay 1
Bd-Pt	01-1.1
Broadcast	No
Type	N-Closed
Control Input	00-0.0 Not configured
Minimum OFF	0 min
Pre delay	0 min
Minimum ON	0 min
Post delay	0 min
Load Shed Level	0
Number of alarms	1
Alarm 1	
Type	Alarm if ON
Delay	15
Units	min
From	12:00 AM
To	12:00 AM
Days	SMTWRFA

Relay Tab

Depending on control requirements the screen layout may differ.

Navigate through the options, adding custom name, AK I/O address, alarms, pre and post delays etc.

Note: Setting Broadcast to yes will make available the relay status on the AK-SM host network.

If a control input is needed to operate your misc relay, this can be selected on the Control Input line (you will need to configure your control input in advance)

If configured, navigate to additional relays via the drop down box

Name: Enter custom description for relay

Bd-Pt: Enter a valid Board & Point address (using AK I/O modules)

Broadcast:

No: The value of the point will not be broadcast to be used in logic on other controllers.

Send: The value of the point (whether it is ON or OFF) will be available on the host network for use by other controllers. Be sure that each sending Board-Point combination is unique throughout the system. (If the controller at address #01 is sending from its Bd-Pt address 1-02, then no other controller can have an output at its Bd-Pt address 1-02 sending.

Rec: The value of the point is being received from another controller on the host network. You must enter, in the Bd-Pt fields, the Bd-Pt address of the sending point.

Type: Normally Closed or Normally Open

Control Input: It is possible to use other defined points (including calculations) to act as the control Input - these will be seen in a drop down list

Minimum Off: Define a min off time period to stop short cycling

Pre Delay: Define a pre time delay before the relay activates

Minimum On: Define a min on time period to stop short cycling

Post Delay: Define a post time delay to minimize short cycling

Number of alarms: Enter the amount of alarms (max 3)

Alarm 1: Enter the alarm level (Disabled, Log only, Normal, Severe, Critical)

Type: Alarm if ON, Alarm if OFF, Cycles (enter number of cycles)

Delay: Enter delay time

Units: Seconds, Minutes, Hours

From: Defines alarm output time window

To: Defines alarm output time window

Days: Define the days associated with alarm

Action: Define the alarm action



Any Misc points configured in the AK-SM system will be shown in the 'System View' under the Power/Misc window

Sensors Tab

The example below shows the Misc Sensors tab. Navigate down the control lines and configure as required.

Example of Misc Sensors Tab

Sensors Tab

Depending on control requirements the screen layout may differ.

If configured, navigate to additional sensors via the drop down box

Navigate through the options, adding custom name, AK I/O address, alarms

Configure alarm setpoint & actions

Name	Value
Name	Outside temp
Bd-Pt	01-1.1
Broadcast	No
Type	PT1000
Number of alarms	1
Alarm 1	Normal
Type	Alarm if above
Limit	50.0
Delay	15
Units	min
From	12:00 AM
To	12:00 AM
Days	SMTWRFA
Action	0
Sensor fail alarms	Disabled

Name: Enter custom description for sensor

Bd-Pt: Enter a valid Board & Point address (using AK I/O modules)

Broadcast:

No: The value of the point will not be broadcast to be used in logic on other controllers.

Send: The value of the point (whether it is ON or OFF) will be available on the host network for use by other controllers. Be sure that each sending Board-Point combination is unique throughout the system. (If the controller at address #01 is sending from its Bd-Pt address 1-02, then no other controller can have an output at its Bd-Pt address 1-02 sending.)

Rec: The value of the point is being received from another controller on the host network. You must enter, in the Bd-Pt fields, the Bd-Pt address of the sending point.

Type: Select from various option in the drop down list (this example uses a PT1000 sensor)

Control Input: It is possible to use other defined points (including calculations) to act as the control Input, these will be seen in a drop down list

Number of alarms: Enter the amount of alarms (max 3)

Alarm 1: Enter the alarm level (Disabled, Log only, Normal, Severe, Critical)

Type: Alarm if above or if below limit (seen below)

Limit: Enter the alarm limit

Delay: Enter delay time

Units: Seconds, Minutes, Hours

From: Defines alarm output time window

To: Defines alarm output time window

Days: Define the days associated with alarm

Action: Define the alarm action

Sensor fail alarms: Enter the alarm level to issue alarm if sensor fails (Disabled, Log only, Normal, Severe, Critical)

On/Off Tab

The example below shows the Misc On/Off tab. Navigate down the control lines and configure as required.

Example of On/Off Inputs Tab

On/Off Inputs	
Name	Value
Name	Heater On/Off
Bd-Pt	01-1.4
Broadcast	No
Type	Voltage
Number of alarms	0

On/Off Tab

Depending on control requirements the screen layout may differ.

Navigate through the options, adding custom name, AK I/O address, alarms

Name: Enter custom description for Input

Bd-Pt: Enter a valid Board & Point address (using AK I/O modules)

Broadcast:

No: The value of the point will not be broadcast to be used in logic on other controllers.

Send: The value of the point (whether it is ON or OFF) will be available on the host network for use by other controllers. Be sure that each sending Board-Point combination is unique throughout the system. (If the controller at address #01 is sending from its Bd-Pt address 1-02, then no other controller can have an output at its Bd-Pt address 1-02 sending.)

Rec: The value of the point is being received from another controller on the host network. You must enter, in the Bd-Pt fields, the Bd-Pt address of the sending point.

Type: Select from various option in the drop down list

Voltage: Voltage Input

No Voltage: No Voltage Input

Latching: Latching Input

Closed: Closed Input

Open: Open Input

Number of alarms: Enter the amount of alarms (max 3)

Alarm 1: Enter the alarm level (Disabled, Log only, Normal, Severe, Critical)

Type: Alarm if above or if below limit (seen below)

Limit: Enter the alarm limit

Delay: Enter delay time

Units: Seconds, Minutes, Hours

From: Defines alarm output time window

To: Defines alarm output time window

Days: Define the days associated with alarm

Action: Define the alarm action

Variable outputs

Using a 0-10V water mixing valve application as an example, the following screen can be used on the AK-SM to provide control. The same principles can be applied against a wide range of control needs. Variable output control can also be seen in certain AK-SM Refrigeration, HVAC and Lighting control screens. Using the Miscellaneous area of the AK-SM a variable output point can be created. After authorization, navigate to the configuration->control page. Enter the required quantity of variable outputs, remembering to also add a sensor input (which will be later used as a water temperature reference).

Next, navigate to the Misc tab and scroll to the variable output tab. Enter a descriptive name and the board & point allocation (the point number will be 1 to 4). Define the working voltage range, here a 0-10 V range is set. The previously configured sensor

input (water temp) can be defined, along with the output % range and is used as the control reference point.

An override relay or switch can be added if required (not used in this example). Finally an analog output fail safe can be configured. The fail safe feature is to ensure safe operation during power outages, network disturbances etc.

The following options are available;

- Stay unchanged - upon failure keep output voltage unchanged
- Maximum output - set output to 100%
- Minimum output - set output to 0%
- Predefined value - user set value %

Example of Variable Output Tab

If configured, navigate to additional Outputs via the drop down box

Name	Value
Name	Misc VarOut 1
Bd-Pt	01-1.2
Range	0-10 Volts
Control Sensor	02-1.1 Water Temp
Output 0% (0.0V) at	72.0°C
Output 100% (10.0V) at	75.0°C
Override type	R0
Override point	00-0.0 Not applicable
AO Failsafe Setup	
Failsafe Type	Predefined value
Predefined Value	75 %
Number of alarms	0

Variable Output Tab

Depending on control requirements the screen layout may differ.

Controlling sensor

In this example the sensor was pre-configured and labelled as 'water temp'

Failsafe value (see below for description)

Name: Enter custom description for Output

Bd-Pt: Enter a valid Board & Point address. Variable output is done via VO2 board (described opposite)

Range: Select from various option in the drop down list:
0-10, 10-0, 0-5 Volts

Control Sensor

Output 0%

Output 100%

Override type (Relay Output, On/Off)

Override point

Failsafe Type (Stay unchanged, Maximum output, Minimum output, predefined value - user definable)

Number of alarms: Enter the amount of alarms (max 3)

Alarm 1: Enter the alarm level (Disabled, Log only, Normal, Severe, Critical)

Type: Alarm if above or if below limit (seen below)

Limit: Enter the alarm limit

Delay: Enter delay time

Units: Seconds, Minutes, Hours

From: Defines alarm output time window

To: Defines alarm output time window

Days: Define the days associated with alarm

Action: Define the alarm action

AK-XM 103A Variable Output board

Your AK-SM fully supports the family of Danfoss I/O modules. The I/O family consists of various analog inputs, digital outputs, and relays. New to the I/O family is the AK-XM 103A (080Z0032) analog input/output module. This new module offers x4 analog inputs and x4 analog outputs, allowing easy control of a variety of control applications.

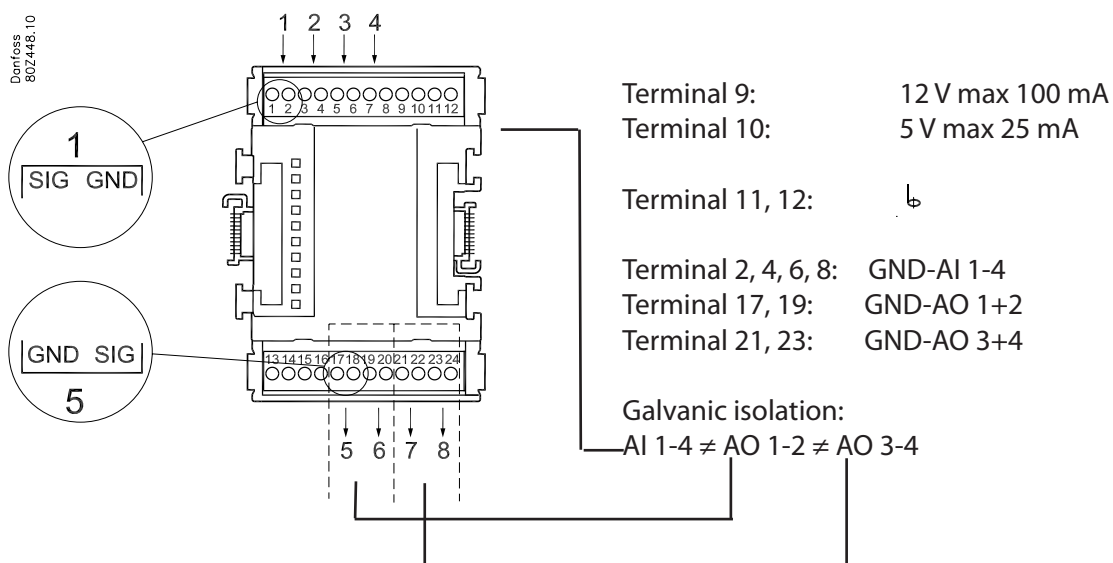
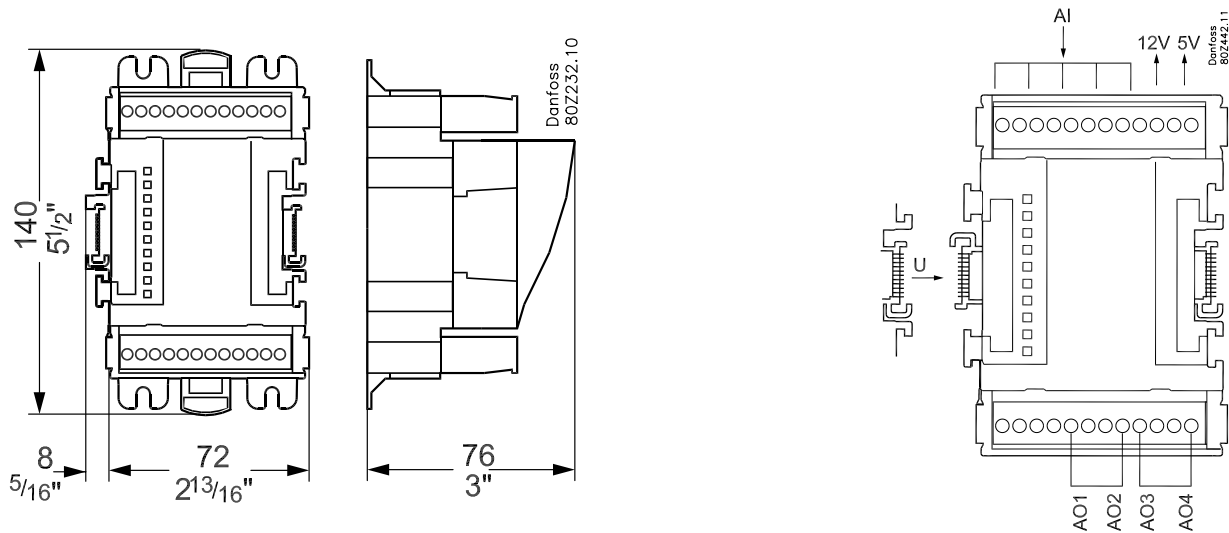

Conversion Factors

Conversion factors are used for sensors that have an output range or range-to-value relationship not already defined as one of the named “types” in the sensor input configuration list box. The following example highlights the Conversion Factor screen.

Example of Conversion Factors Tab

Conversion Factor Tab

Depending on control requirements the screen layout may differ.

Location: Configuration Control Misc

Relays Sensors On/Off Inputs Variable Outputs Conv Factors Calculations

Conv Factors	
Name	Value
No. of conversions	1
Conv 1	Conv 1
Units	'F
Minimum input	0.0V
Maximum input	10
Minimum output	0.0 'F
Maximum output	100 'F

No of conversion factors: Enter the required amount of conversion factors

Conv 1: Name for conversion factor (user changeable)

Units: Select from a range of unit types:

- psi
- Bar
- °F
- %
- °C
- ppm (Parts Per million)
- V (Volts)
- Amp
- Kw
- kWh
- Hz
- gpm (gallons per min)
- fps
- pH
- fc
- lpm (litres per minute)
- lps (litres per second)
- Minimum Input:
- Maximum Input:
- Minimum output:
- Maximum output:
- Lux:

Managers Override

Configuration -> Control

From the Configuration->Control menu select the number of managers override required.

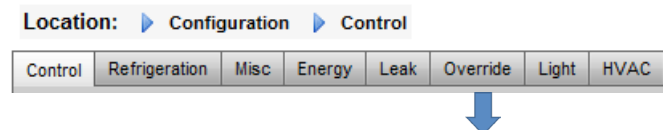

To configure the override, navigate to the 'Override' menu tab and follow the below guidelines

Manager's Override	
Number of overrides	1

The managers override function allows the authorized user to place Lighting zones and or HVAC units into an override state. The expected implementation for this feature is to provide some mechanical switch in the store managers office or loading bay. The following options can be seen in the configuration of the manager's override;

Timed Override (Yes/No)

YES- The override will last for the time selected in the 'duration (in Hours)' line. The point will return to normal operation after this time has elapsed.

NO- The override will last until it's switch on the override box is operated a second time

Interrupt enabled (Yes/No)

YES- The override can be interrupted by a second operation of the override switch

NO- The override cannot be interrupted, the point will remain in override status for the duration of the selected time

Override is for

Lighting – lighting zones

HVAC- HVAC units (requires suitable license)

Both – The override is for both Lighting and HVAC

Other Unit – The override is for a point located on another AK-SM 800(Host network)

Override all zones (Yes/No)

YES- All lighting zones will be overridden

NO- One or more lighting zone (see details below) will be overridden

Override all units (Yes/No)

YES- All HVAC units will be overridden

NO- One or more HVAC unit (see details below) will be overridden

The 'Select zones' and 'Select units' buttons appear as needed to let you choose the lighting zones and HVAC units to be overridden. Each will give you a list from which you can select the specific zones or units to be overridden

Configuration for 'Other Unit' Overrides

If the point to be overridden is on another controller, you must configure a Managers override for that unit. Usually, there will not be an actual override box on the remote unit. Use the same board and point number you used for the actual override box. It is a good idea to make the name of the point the same too. Then make sure to configure the board & point with the same board and point number used for the actual override box, and set the Bcast point to Rec.

Location: ▶ Configuration ▶ Control ▶ Override

Manager Override	
Addresses	
Manager Override	
Name	Value
Name	Override 1
Is this a timed override	No
Interrupt enabled	No
Override is for	Both
Override all units	No
Override all zones	No
Select Units	
Select Zones	

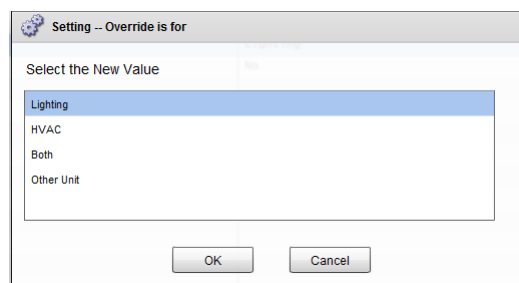

Lighting Configuration

Configuration -> Control -> LIGHT

Your AK-SM has the built in ability to support lighting schedules and control via Danfoss I/O modules or via lighting panel communications.

Typically the built in lighting control function is used to manage general store lighting applications. The initial lighting configuration is set out under the Configuration->Control page. The initial control question asks how many lighting zones are required. The AK-SM has the ability to share any indoor photocell configured and to define how many photocells are required. Once these initial control questions have been completed the remaining configuration is done under the **Configuration->Control->Light**. Lighting control is done via built in AK-SM schedules, and the optional use of photocells. The following section describes a typical lighting configuration, using AK-SM control.

Location: Configuration Control

Control	
Show only scanned devices	No
Refrigeration	
Number of racks/packs	0
HVAC	
Number of HVAC units	0
Lighting	
Number of lighting zones	1
Zones share indoor photocells	No
Zones share shutdown input	No
Number of Powerlink panels	0
Number of Cutler-Hammer panels	0

Detailed configuration is done under the Light tab (Configuration->Control->Light)

The initial Lighting configuration is done under the Configuration->Control page.



Danfoss recommends wiring any lighting circuits in **Normally Closed** position. This will ensure that if power fails to the AK-SM or I/O modules the lighting systems will 'fail safe' 'ON'

AK-SM Built in LIGHTING control (Using AK Input / Output / schedules & Photocells)

The following control options can be seen in the Lighting tab, navigate and press the enter key to change / configure any relevant points.

Location: Configuration Control Light

Lighting	
Zone 1	
Lighting	
Name	Value
Zone name	User Def.
User defined name	Zone 1
Zone Type	AK-I/O
Photocell	None
Num of schedules	1
Num of control relays	1
Override switch	No
Burglar override	No
Fire override	No
Shutdown Input	No
Load Shed Level	0
Schedules	
Type 1	Standard
Start 1	12:00 AM
Stop 1	12:00 AM
Days 1	SMTWRFA
Holidays 1	12345678

Zone Name: Custom description (User Def) or select from a drop down list

User Defined Name: Enter required name

Photocell: None (no photocell), Inside photocell, Outside photocell or Skylight

Control Sensor: Min: The lowest-reading photocell at any given time will be used as the control sensor. **Max:** The highest-reading photocell at any given time will be used as the control sensor.

Average: All photocells are averaged, and the average value is used as the control sensor value. **Photocell ID#1** (etc.): If any specific photocell is selected, its value alone will be used as the control sensor value.

Num of Schedules: The number of schedules for this point.

Control Method: Schd and photo: For this point to be on, two conditions have to be satisfied: (1) the schedule must be true; and (2) the photocell must be above trip level. Once those two conditions are satisfied, the pre-delay timer will start. **Schd or**

photo: For this point to be on, either of two conditions must be satisfied: (1) the schedule must be true; or (2) the photocell must be above trip level. Once one of those two conditions is satisfied, the pre-delay timer will start.

Tip! For outside lighting control via photocell, the light level needs to be below the trip level. In the case of interior lighting, turn off lights when we're above a trip level.

Num of control relays: Each zone is controlled by a relay output (digital output) on the I/O network.

Trip Level %: The % level at which the photocell condition will be true and act to turn the lights on. (If multiple relays are configured, there will be one trip level per relay.)

Range: +/-: The range selected creates a dead band.

Pre Delay: When lights are off, the number of minutes that the lighting condition must be satisfied before lights will be turned on.

Post Delay: When lights are on, the number of minutes that the lighting condition must be false before lights will be turned off.

Minimum on Time: When lights are turned on, the number of minutes that they must remain on before being turned off.

Minimum off Time: When lights are turned off, the number of minutes that they must remain off before being turned on.

Override Switch: (Yes / No) Whether or not there is an override switch assigned to the zone.

Override Duration: The duration of an override when the override switch is used.

Burglar Override: When this zone's lights are turned off, whether they are to be turned on when a monitored burglar alarm is sensed.

Fire Override: When this zone's lights are turned off, whether they are to be turned on when a monitored fire alarm is sensed. There is no pre-delay for fire alarms.

Enable Dimmer output: Whether or not a dimmer variable output will be controlled.

Target %: The photocell level that the controller will seek to maintain by operation of the dimmer.

Minimum output (0.0v): The minimum dimmer level.

Maximum output (10.0v): The maximum dimmer level.

Algorithm sensitivity:

Algorithm interval:

Max rate of change (% / Sec):

Tip! Target % applies if 'inside' or 'outside' photocell used. If a skylight photocell used, then the min output/max output (slope between 2 points) approach is enabled.

Schedules:

Type 1: Standard (directly linked with AK-SC lighting schedule), Relative (a time that is defined before or after the scheduled start /stop times).

Start1: Scheduled Start time

Stop 1: Scheduled Stop time

Days 1: Days of the week that will apply to this schedule

Holidays: Holidays that will apply to this schedule

ADDRESSES

Configuration->Control->LIGHT->Addresses

After the relevant Lighting control questions have been configured, appropriate AK I/O addresses need to be applied. The address inputs correspond to the Board & Point address of the AK I/O modules. Depending on the control definition made in the previous (Configuration->Control->Light) screen various inputs will require board & point addresses. Navigate through the Relays, Sensors, On/Off Inputs & variable tabs to define the relevant outputs (Skip the controllers tab as all control is done via AK I/O).

Tip! Standard schedule (eg. on / off time 8 am to 10pm) Relative means, relative to the open/closed hours. I.E. Open hours are 8 am until 10 pm and a certain lighting zone needs to come on 15 minutes prior to start of open hours until 30 minutes after closing, the schedule would look like the following; -0015 on --> +0030 off (so, being relative, the lights are on at 7:45 am and off at 10:30 pm)

ALARMS

Configuration->Control->LIGHT->Alarms

After the relevant Lighting control questions and appropriate AK I/O addresses have been applied, check the alarms tab. Depending on the Lighting control configuration alarm points will be seen under the alarm tab.

Location: Configuration > Control > Light > Addresses

Controllers Relays Sensors On/Off Inputs Variable Outputs VLT LP

Zone 1 Relays

Name	Value
Zone 1	Zone 1
Address	00-0.0
Type	N-Closed

Navigate through the various control lines, enter custom description & valid address (Board & Point) that reflect the location on the AK I/O network

Setting -- Address

Input New Value

Address Type

Calculated
 AK-CM
 Controller
 AKAccess

Address		
Node	Mod	Point
0	0	0
00-0.0		
N-Closed		

OK Cancel

Dimming control via AK I/O

The AK-SM 800 offers the ability to dim lighting controls via the use of Danfoss AK I/O dimming systems. The following section describes initial setup and configuration.

Location: Configuration Control

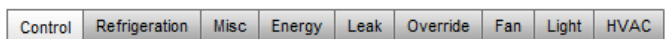

From the Configuration menu, navigate to the 'Control' screen. Enter the number of lighting zones required

Lighting		
	Number of lighting zones	1
	Zones share indoor photocells	No
	Zones share shutdown input	No
	Number of MCX Light units	0

From the Configuration->Control screen navigate to the Light (Lighting) sub tab. The control method setup MUST be '**Schd and photo**'. To use the dimmer night setback option, ensure '**Skylight**' is selected.

Select Number of control points

Trip level: 2000fc A middle range setpoint.

Trip Range +/- : The value added to the trip level to turn Sales Lights OFF and allow them back ON.

Trip level of 2000 fc "plus" 200 trip range will turn lights OFF at 2200 fc.

Trip level of 2000 fc "minus" 200 trip range will allow sales lights back ON at 1800 fc.

Location: Configuration Control Light

Lighting			
Lighting	Addresses	Alarms	MCX
Zone 1			
	Zone name	User Def.	
	User defined name	Zone 1	
	Zone Type	AK-I/O	
	Photocell	Skylight	
	Num of schedules	1	
	Control method	Schd and photo	
	Num of control relays	1	
	Trip Level 1	0.0 lx	
	Trip range +/-	0.0 lx	
	Pre delay	0 min	
	Post delay	0 min	
	Minimum ON time	0 min	
	Minimum OFF time	0 min	
	Override switch	No	
	Burglar override	No	
	Fire override	No	
	Enable dimmer output	Yes	
	Min out at	0.0 lx	
	Max out at	0.0 lx	
	Minimum output (0.0V)	0 %	
	Maximum output (10.0V)	100 %	
	Use dimmer night setback	No	
	Algorithm interval	5 sec	
	Max rate of change (%/sec)	1.0 %	
	Shutdown Input	No	

Pre delay: Delay in minutes before the zone can come ON.
(Scheduled time)

Post delay: Delay in minutes before the zone can be turned OFF.

Minimum ON time: The time that must elapse once the zone has been turned OFF, before the zone can be turned OFF again.

Minimum OFF time: The time the zone MUST stay stay OFF before coming back ON.

The 'Min Out & Max Out' fields would be interpreted as follows:

Min Out at: If the skylight sensor indicated a reading greater than or equal to **1800** footcandles (fc), the dimmer would be set to **2%** . **(Minimum output)**

Max out at:

If the skylight sensor indicated a reading at or below **800** fc, the dimmer would be set to **65 % (Maximum output)**.

All readings between these 2 extremes would set the dimmer output per the following:

$$\frac{(\text{'Min out at' - sensor})}{(\text{'Min out at' - 'Max out at'})} \times (\text{'Max. output' - 'Min. output'}) + \text{'Minimum output'}$$

Thus, a sensor reading of 1200 fc would result in a dimmer output of:

$$\frac{(1800 - 1200) 600}{(1800 - 800) 1000} \times (65\% - 2\%) + 2\% = \frac{600}{1000} \times 63\% + 2\% = 39.8\%$$

Based on "default" setpoints, the algorithm will work as follows:

Dimming Algorithm Reference Table

Actual foot candle	VO%
800	65% (Max)
850	62%
900	59%
950	55%
1000	51%
1050	49%
1100	45%
1150	43%
1200	40%
1250	37%
1300	32%
1350	30%
1400	27%
1450	24%
1500	20%
1550	17%
1600	15%
1650	11%
1700	8%
1750	5%
1800	2% (Min)

Algorithm interval is the algorithm cycle.

Max rate of change is the percentage of adjustment per second. With a setting of 1 % for a 1 second algorithm cycle, and a 2% minimum and 65 % maximum output, the full range can be covered in 63 seconds. (1 percent per second for 63 steps.)

This schedule turns the zone ON and OFF on a time base. (Setup for 24 hours)

Once the main configuration screen is complete, navigate to the Variable Outputs tab, where a board and point address can be added for the 0-10 vdc board

Setup of analog inputs:

Skylight sensor to PHOTO-SKY type

Dimmer feedback to misc. conversion factor DIM FEEDBK

Location: Configuration Control Light Addresses

Zone 1	Variable Outputs
Zone 1	Zone 1
Address	01-1.1
Type	0-10 Volts

Location: Configuration Control Light Addresses

Zone 1	Sensors
Zone 1	DimrFB
Broadcast	No
Address	01-1.2
Type	Percent 10V
PhotoCell Sky	PhotoCell Sky
Broadcast	No
Address	01-1.3
Type	PHOTO-SKY

Once the lighting configuration is complete the details can be seen in the zone lighting detail screen. The detail screen will reflect status, Settings and Service tabs.

Parameter	Value
Status	Off
Alarm	OK
Address	01-1.1
State	OFF
Photozell	0.0%
Schedule	Previous: 12:00AM To 12:00AM
Control Relays	
1	Off
Dimmer out	0
FeedBk	0
Run Times	
Today	00:01
Yesterday	00:00
Total Hrs	0
Maint Hrs	0
Cycles	



HVAC Configuration

Configuration -> Control -> HVAC

The AK-SM 820 and AK-SM 880 both offer HVAC control and support. Both the AK-SM 820 and 880 offer the same HVAC functionality, the only difference is the number of HVAC units that can be configured. HVAC control and support can be via centralized or de-centralized control. Centralized control offers the ability to control HVAC systems via Danfoss AK I/O modules. The de-centralized method allows support for specific field bus nodes.

Initially, navigate to the 'Configuration ->Control' screen, and then declare how many HVAC units you require. In addition to the number of HVAC units, the following questions will also be populated;

- # of phase loss monitors
- # of humidity sensors
- # of dewpoint sensors

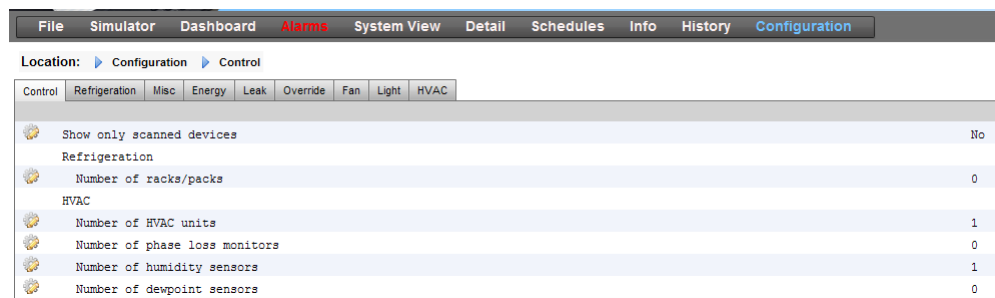

The example below describes a typical centralized control method. As seen in the Refrigeration section, the built in HVAC control is based around a list of control questions. When answering these questions, the control inputs / outputs are being built and will be visible in the Address tab. Navigate to the 'Configuration->Control->HVAC' screen; here you will need to declare what type of HVAC control method is to be used.

For centralized control, select 'AHU' or 'RTU' from the drop down list. If you require de-centralized (field bus) control, select the controller type from the drop down list. Once selected use the setup tab to continue configuration. In the example below, AHU has been selected.

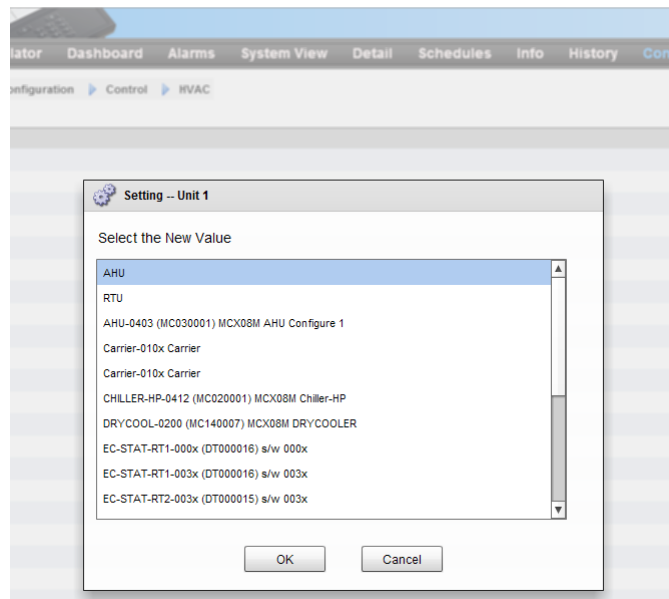

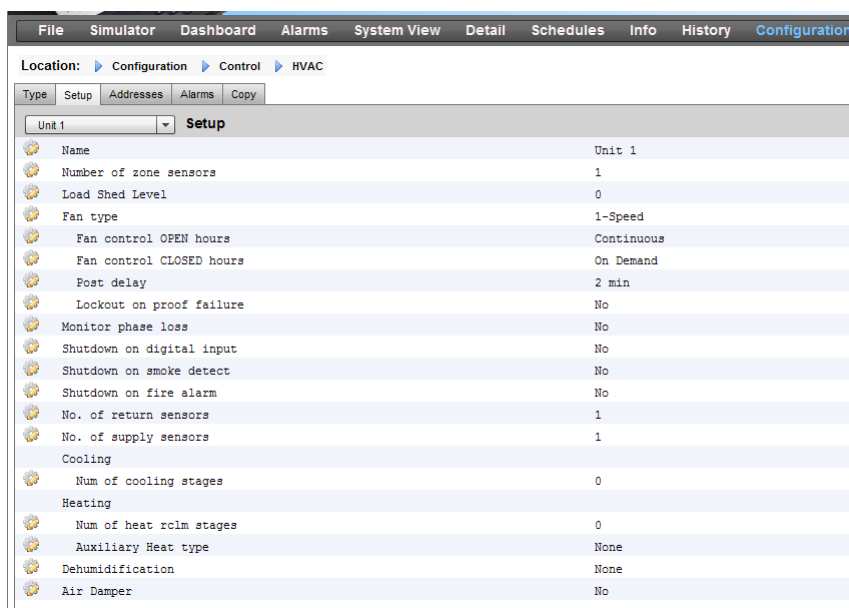

Location: Configuration Control HVAC	
Type	Setup
Unit 1 Setup	
Name	Unit 1
Number of zone sensors	1
Load Shed Level	0
Fan type	1-Speed
Fan control OPEN hours	Continuous
Fan control CLOSED hours	On Demand
Post delay	2 min
Lockout on proof failure	No
Monitor phase loss	No
Shutdown on digital input	No
Shutdown on smoke detect	No
Shutdown on fire alarm	No
No. of return sensors	1
No. of supply sensors	1
Cooling	
Num of cooling stages	0
Heating	
Num of heat rclm stages	0
Auxiliary Heat type	None
Dehumidification	None
Air Damper	No

Number of Zone sensors: The number of zone sensors in the area of the store served by this HVAC unit.

Fan Type: 1-Speed: The unit has a single-speed fan. 2-Speed: The unit has a two-speed fan.

Fan control OPEN hours: Continuous: The fan will run continuously during open hours. Store open hours are defined in the Configuration->Time tab. On demand: The fan will run on demand during open hours. "On demand" means that the fan will run whenever conditions calling for heating, cooling, dehumidification, or venting are met.

Fan control CLOSED hours: Continuous: The fan will run continuously during Closed hours. Store Closed hours are defined in the Configuration->Time tab (the closed period is from Close time to Open time). On demand: The fan will run on demand during Closed hours. "On demand" means that the fan will run whenever conditions calling for heating, cooling, dehumidification, or venting are met.

Post delay: The number of minutes that the fan will run after the last stage of heating, cooling, etc. is turned off.

Lockout on proof failure: Yes: The fan will be locked out if fan proof is lost for five minutes. Human intervention will be needed to restart the fan by using the "Clear" button on the status screen. Evidence of the locked out condition, and the means of ending the lockout, are found on the status screen for cooling or heating function. No: The fan will not be locked out on proof failure.

Monitor Phase Loss: Whether or not a phase loss monitor will be monitored.

Which phase loss monitor: All available phase loss monitors are shown.

Shutdown on phase loss: Whether or not the unit is to be shut down when its phase loss detector input is on.

Shutdown on digital input: HVAC unit will shut down based on a digital input

Shutdown on smoke detection: Whether or not the unit is to be shut down when its smoke detector is on.

Shutdown on fire alarm: Whether or not the unit is to be shut down when a monitored fire alarm is detected.

No. of return air sensors: (1-3)

No. of supply air sensors: (1-3)

Cooling

Num of cooling stages: (1-3) The number of cooling stages in this HVAC unit.

Proof: Cooling stage will be monitored for it's actual run status

Stage x (where x is either stage 1,2 or 3)

Target: Enter required target temperature

Pre Delay: The number of minutes that must elapse after target plus range is reached before the stage will come on.

Post Delay: The number of minutes that must elapse after target - range is reached before the stage will be turned off.

Range +/- : The range selected creates a dead band. For example, if the target is 72 and the range is 2, the stage will come on at 74, and will not be turned off until the temperature reaches 70.

Ambient temp lockout: Whether or not there is to be a lockout based on low outside ambient temperature.

No Cooling below: The ambient temperature below which cooling will be locked out.

Range +/- : The range selected creates a dead band. For example, if the lockout is 50 and the range is 2, cooling will be locked out at 48 and will be allowed on at 52.

Default fan Speed: The fan speed for cooling. A different fan speed can be chosen for dehumidification when it is configured.

Max suction press safety: Lists every configured pressure sensor. Any may be selected. Only the suction pressure for the cooling compressor in this rooftop should be used.

No cooling above: The pressure value of the sensor selected on the previous line at and above which cooling will be cut out. Cooling will not cut in again until the pressure falls below this value and the pre delay specified in the HVAC control page.

Freeze protection:

Sensor Input: There is a leaving air temperature for each stage of cooling, near the coil. At and below the setpoint (next line), the cooling stage will be turned off.

On/Off Input: A single digital input that when ON will turn off all stages of cooling in the RTU (Roof Top Unit)

None: There is no freeze protection to configure.

Night Setback: Whether or not the cooling setpoints are to be raised by an offset (next line) during scheduled times (next page) when cooling requirements are not as critical; for example, when the building is closed.

Night Setback offset: The amount by which the cooling setpoint is to be raised when night setback schedules (next page) are in effect.

Num of schedules: The number of cooling night setback schedules.

Override switch: Whether or not there is a switch to override night setback.

Override duration: The number of minutes after, activation of the override switch, that night setback will be overridden.

Night Setback schedules:

Type: Standard = based on start / stop times configured in following lines. Relative = based on store schedule with offset time applied

Start : Start time

Stop: Stop time

Holidays: Any holidays, as defined under Configuration->Time

Heating:

Auxiliary Heat type: None: There is no auxiliary heat. Staging: Auxiliary heat is staged. Gas Valve: Auxiliary heat is regulated by a modulating gas valve, Gas/Staging xxx

Stage x

Target: Heating target temperature

Gas Valve:

Control from:

Supply Target:

Control gain (% degree):

Integral time:

Min valve opening:

Max valve opening:

Low fire position:

Low fire duration:

Ambient heat lockout:

High Supply temp lockout:

Fan Speed:

Night setback:

Night setback offset:

Num of schedules:

Override switch:

Night setback schedules:

Dehumidification:

'None' or 'cooling' (humidity, dewpoint or calculated dewpoint, and related setpoints and delays)

Air Damper:

If set to 'yes' it provides pre-delay, post-delay, ambient air temperature lockout and schedule options

AK-SC Built in HVAC control (Using AK Input / Output)

Following from the Controllers tab, the Relay, Sensor, On/Off Inputs & Variable Outputs tabs allow the adding of the relevant I/O modules required for built in HVAC. Each line would have been 'built' depending on the answers given in the various HVAC setup screens (previously described).

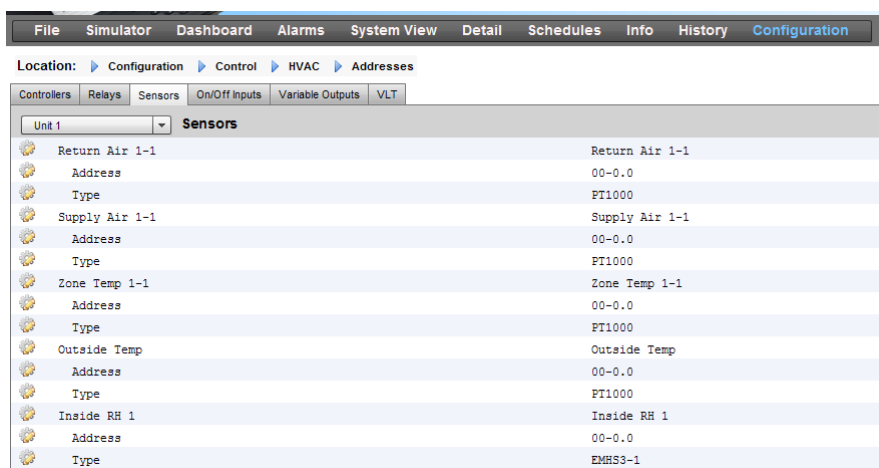

If required, enter unique description.

Enter correct address for the Board & Point input.

Type can be changed according to the selections in the type drop down list.

HVAC Alarms - Alarms Tab

The alarms for the individual HVAC unit can be found under the Alarms tab.

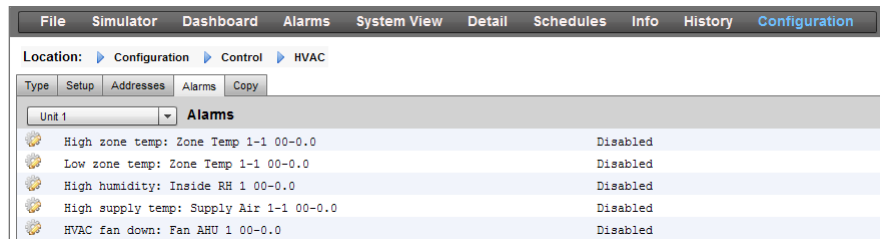

Scroll down each appropriate line and press enter to change the alarm level, the available options being the same as found in previous alarm tab configurations. In addition to the alarm level, an alarm action number can be set (1-8), configure the alarm actions in the central alarm routing page (Configuration->Alarms).

Note: For alarms to correctly activate, the central alarm routing page must also be configured. See Configuration-> Alarms

Define the Alarm Action for each alarm output - this links with the central Alarms->Routing page.

Define the Alarm level (Disabled, Log Only, Normal, Severe, Critical, Delete).

CoreSense™ (Modbus) Support

Danfoss AK-SM 800 series version 08.053 and higher supports select Emerson modules within the CoreSense™ range. In particular, the following two module types are supported (see important notes below for supported versions)

- CoreSense™ Diagnostics for Copeland Scroll K5 compressors
- CoreSense™ Protection for Copeland Discus compressors

CoreSense™ Protection Support note:

Only certain versions of CoreSense™ Protection modules are supported, please observe the following requirements. **CoreSense™ Modules that have 10 dip switch must have firmware version F33 or newer.** All module versions that have 12 dip switch are supported, no known firmware constraints.

CoreSense™ compressor support requires a valid Modbus network to be in place, following standard Modbus topology rules (point to point, no star connections). Ensure each module follows the manufacturer's recommendation for unique addressing (via module) bit switch and correct terminal wiring. Ensure the last node on the Modbus network has 120Ohm resistor in place.

Each module must be set for 'Stand Alone Mode', else invalid module alarms will occur. To set the modules for 'Stand Alone Mode' use the relevant bit switches on the module—refer to the CoreSense™ user guide for more details.

Once all network cabling, node addressing, and Stand Alone Mode are defined, the SM800 can now scan the Modbus network to discover the nodes. Enter valid authorization and navigate to the Network Nodes screen. The Channel Modbus RS-485 must be enabled and 'SLV/CSENSE' must be set to "Yes" for the 19,200 Baudrate (default Baudrate) before pressing rescan. The Modbus address must be unique across all channels.

After the rescan is completed, verify the "Nodes Scanned on Network" for the new scanned nodes. Also, verify the "Generic" Node types for the new scanned nodes after a successful rescan. The address, type and the software version of the detected CoreSense™ modules can be viewed under the Configuration -> Network Nodes -> Scan Status tab.

Once the scan is complete, the CoreSense™ modules can be configured under the "Configuration->Control->Refrigeration" tab of the SM800 series Control Tab. The number of CoreSense™ modules to be configured must be entered for each suction group. Select the relevant ED3 file for the module (under the "Type" Tab Configuration -> Control -> CompView -> Type for each configured CoreSense™ module). Enter a unique address for each CoreSense™ module under the "Addresses" tab. Under the "Setup" tab it will show 6 other tabs to:

- 1) Alarms: Enable or disable the alarms for a generic device
- 2) Copy: Copy devices in the offline configuration
- 3) Upload: Upload the parameters from the device
- 4) Download: Download the parameters to the device
- 5) Import SI: Import the parameters as SI
- 6) Import OI: Import the parameters as OI

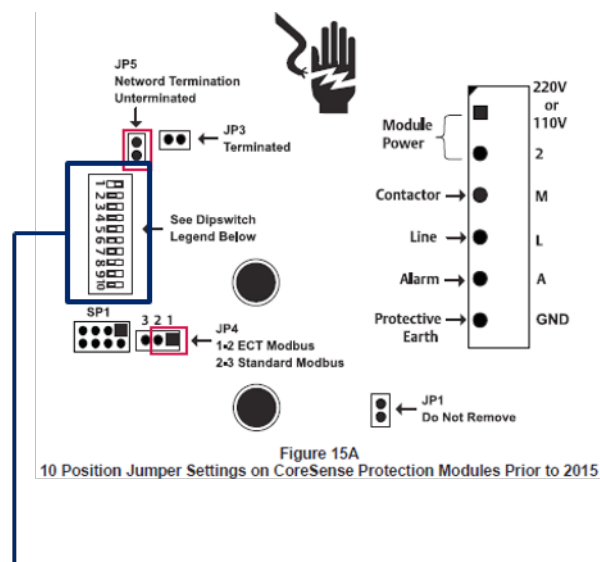

10 DIP switch version. Only Firmware Version F33 or newer is supported

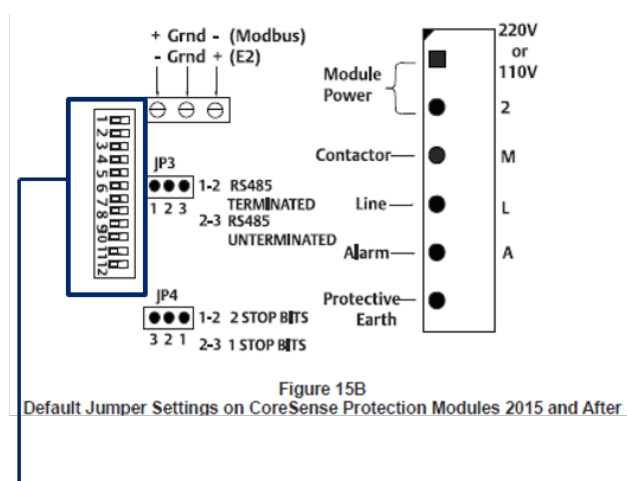

12 DIP switch version. All Firmware Versions supported

Energy Measurement / Load shed

Feature Introduction

A new feature introduced in SM800 version 08.053 and above allows the measurement and subsequent load shedding of electrical loads. This feature allows the consideration of tariff data, which can be then used to load shed equipment associated with a digital input. The use of Danfoss AK-IO modules is required for this feature.

Feature highlights

- Measuring period synchronization
- 3 Tariffs in kW (High Tariff, Normal Tariff, Strong Tariff)
- Scale factor for current and voltage transformers
- Pulse / unit

Load shed based on

- Start and stop shed borders
- Shed level
- Min OFF, Pre and Post delay in minutes
- Maximum OFF in seconds

Additional features

- Preset of counters
- Self-synchronization possibility
- Alarm on load shed limit
- Neutral zone in period
- Reset for average, value yesterday, value last week, kWh, kW or all in one go

Configuration

Follow the guidelines in this section in order to configure energy measurement and load shed

Go to Configuration -> Control

Change the number of meters (max. 80)

Go to Configuration -> Control->Energy

Select Pulse / kW

Go to Tab Setup

Select Pulse / unit

Give counter a name and fill in all appropriate details

Self sync Period.

In case the external contact is not working properly, SM800 will synchronize the measuring period internally

Self sync Timeout

If the last time sync is not a self sync timeout, the SM800 will wait for xx sec, before it will synchronize the measuring period internally

Type of metering

Conventional way is unit/pulse. The new way is pulse/unit

Sync.mode

Special: Measuring period syncs on tariff change Normal: Tariff changes after external synch

Pulse/unit

Pulse meter constant

Scale factor

Factor, to adapt the pulse meter constant to current and/or voltage transformers.

Preset counter

Set SM800 kWh to the value of the utility meter. Clear counter will reset the value.

Collect history

Enable SM800 to collect data for consumption view from this particular meter

Location: Configuration Control Energy

Type	Setup	Addresses	Demand Response
New metering		Setup	
Name	New metering		
Selfsync Period	15 min		
Selfsync Timeout	20 sec		
Type of metering	Pulse/unit		
Sync. mode	Special		
Pulse/unit	1000		
Scale factor	200.0		
Preset counter	0.0 kWh		
Collect History	Yes		
Use unit for demand lim	Yes		
Start shedding at	90 %		
Start restoring at	85 %		
Alarm if above	150 %		
Maximum levels	4		
Tariff Limit HT	3600.0 kW		
Tariff Limit NT	4500.0 kW		
Tariff Limit ST	3200.0 kW		
Neutral time	60 sec		
Level time	10 sec		
Period Peak duration	15 min		

Use unit for demand limitation

Enable SM800 to use this (and only this) meter for load shed.

Start shedding at

SM800 is constantly calculating the energy which is allowed until the rest of the period without the risk to pass the max. limit. In this example the load shed starts if 90% of the max value is reached

Start restoring at

SM800 is constantly calculating the energy which is allowed until the rest of the period without the risk to pass the max. limit. If the energy consumption is decreasing and the system is satisfied with the calculation the restoring of the levels starts. In this example the restoring starts if the consumption falls below 85% of the max value.

Alarm if above

If the system is passing above the limit an alarm will be created. In this example the alarm will be send out if the limit is 50% above the max value.

Maximum level

The system can handle max 4 levels (priorities) for load shed

Tariff limit HT/NT/ST

Maximum value in kW

Neutral time

Time in sec. for the beginning of a period where load shed is inactive

Level time

Time how long the calculation stays in a level before it goes to next level

Period Peak duration

Basis time for calculation on the peak

Addressing:

Go to Tab Addresses and On/Off Inputs to find the addresses for synch and tariffs.

NT does not need an address because it is NT, if it is not HT.

If ST is active it doesn't matter which status NT or HT has.

Location: Configuration Control Energy Addresses

Controllers Relays Sensors On/Off Inputs Variable Outputs VLT

New metering On/Off Inputs

Sort by	Creation
Emergency Switch	Emergency Switch
Broadcast	No
Address	00-0.0
Type	Voltage
Sync. Input	Sync. Input
Broadcast	No
Address	02-2.2
Type	Open
Tariff HT	Tariff HT
Broadcast	No
Address	01-2.4
Type	Open
Tariff ST	Tariff ST
Broadcast	No
Address	01-2.5
Type	Open

Detail View

Status

Overview Alarm History Log Status/Settings
Device Detail: New metering #0 Master ⚡

Status 835167.4 kWh

Alarm OK

Address 01-23

Status Settings Service Consumption
Updated: 13:45:23

KWh Consumption	835173.0 kWh
Current kW Load	734.0 kW
Average	737.6 kW
Yesterday	17702.8 kWh
Last week	0.0 kWh
Peak kW	751.7 kW
Occurred	02/09/16 02:47
Period Peak kW	737.6 kW
Occurred	19/09/16 13:44
Peak reset on	31/08/16 07:23
kWh reset on	01/08/16 10:31
Actual Tariff	Tariff HT
Actual Tariff Limit	3600.0
Remaining time	152 sec
Level	0
Load is 20% of maximum load	

Settings (see also configuration)

Overview Alarm History Log Status/Settings
Settings (see also configuration)
Device Detail: New metering #0 Master ⚡

Status 835179.6 kWh

Alarm OK

Address 01-23

Status Settings Service Consumption
Updated: 13:45:04

Name	New metering
Selfsync Period	15 min
Selfsync Timeout	20 sec
Type of metering	Pulse/unit
Sync. mode	Special
Pulse/unit	1000
Scale factor	200.0
Preset counter	0.0 kWh
Collect History	Yes
Use unit for demand lim	Yes
Start shedding at	90 %
Start restoring at	85 %
Alarm if above	150 %
Maximum levels	4
Tariff Limit HT	3600.0 kW
Tariff Limit NT	4500.0 kW
Tariff Limit ST	3200.0 kW
Neutral time	60 sec
Level time	10 sec
Period Peak duration	15 min

Service

Overview Alarm History Log Status/Settings
Device Detail: New metering #0 Master

Status 835192.0 kWh

Alarm OK

Address 01-2.3

Status Settings Service Consumption

Updated: 13:47:07

- Press to reset All
- Press to reset Average
- Press to reset yesterday
- Press to reset last week
- Press to reset kWh counter
- Press to reset peak kW value

Consumption

Overview Alarm History Log Status/Settings
Device Detail: New metering #0 Master

Status 835198.2 kWh

Alarm OK

Address 01-2.3

Status Settings Service Consumption

Updated: 13:47:41

View Day

- Mon Sep 19 2016
- Previous day
- Next day
- Previous month
- Next month

Total kWh	2576.6
Peak kW	749.0
Occurred	12:15

The place for the address of the utility meter pulse did not change.
Still available here under sensors

Location: [Configuration](#) [Control](#) [Energy](#) [Addresses](#)

Controllers Relays Sensors On/Off Inputs Variable Outputs VLT

New metering **Sensors**

- Sort by Creation
- New metering New metering
- Broadcast No
- Address 01-2.3

Coordinated Adaptive Defrost

Danfoss offers a range of ADAP-KOOL® controllers that have an adaptive defrost function which allows the case controller to skip scheduled defrost cycles that are not necessary to carry out. Adaptive defrost is based on a real time monitoring of the evaporator performance.

By using the electronic expansion valve as a mass flow meter, it is possible to compare the energy balance between the refrigerant side and air side of the evaporator. By means of this comparison, it is possible to calculate the airflow through the evaporator when it is clean.

By monitoring the degrading air flow through the evaporator, it is possible to estimate the ice build-up on the evaporator. In order to calculate the mass flow of the refrigerant, the case controller uses the opening degree of the electronic expansion valve as well as the pressure differential across the valve.

Refrigerated cases are normally defrosted in groups corresponding to how they are placed physically in the store, for instance all case sections of a refrigerated island are defrosted at the same time. If multiple case sections share the same air flow, the defrost cycle must be co-ordinated, so that all case sections start defrost at the same time and start refrigeration when all cases of the group have terminated defrost.

In order to maximize the number of saved defrost, the case controllers have to be grouped into smaller sub-groups of controllers sharing the same air flow. It is more likely that a group of 3 case controllers all are willing to skip defrost compared to a group of 8 case controllers.

The 'ADAP-KOOL® system' offers a failsafe procedure that ensures that the refrigerated cases are defrosted in case of error conditions (e.g. lost communication).

The pack controller provides a filtered value of the condensing pressure P_c converted into saturated temperature T_c . For pack controllers handling trans-critical CO₂ systems, the liquid receiver pressure must be distributed to the case controllers. This filtered value of the condensing/liquid receiver temperature is used by the adaptive defrost algorithm in the case controllers.

Automatic adaptation to the evaporator

When adaptive defrost is activated it will carry out an automatic "tuning" in order to adapt itself to the relevant evaporator. The first tuning takes place after the first defrost so that tuning can be carried out on an evaporator without ice formation. New tuning subsequently takes place after each defrost (but not during night with night blinds using defrost function 2). In a few cases it may happen that the function is not correctly adapted to the relevant evaporator. This is usually because the automatic adjustment has been made under abnormal operating conditions at start-up/ or testing the system. This will result in the function reporting an error state. If this happens, a manual reset of the function should take place while briefly setting the adaptive function switch to "0" (OFF).

Status display

For each evaporator it is possible to display the current operating status for adaptive defrost:

- 0: OFF Function not activated
- 1: Sensor error state – waiting for sensor OK
- 2: Tuning Function carries out automatic tuning
- 3: OK – no ice build-up
- 4: Slight ice build-up
- 5: Medium ice build-up
- 6: Heavy ice build-up

Defrost Control	Status	Updated: 15:24:20
--- Ctrl State	(#11) Normal	
u17 Ther Air	3.9 °C	
u12 S3 Air Temp	3.9 °C	
u16 S4 Air Temp	2.9 °C	
--- AKV OD %	0 %	
u26 Evap Temp Te	-10.0 °C	
u20 S2 Temp	2.9 °C	
u09 S5 Temp	3.2 °C	
u36 S6 Temp	120.0 °C	
u11 Defrost Time	60 min	
U01 AD State	0-Off	
U10 Acc Defrost	0	
U11 Acc Def Skip	0	
--- Defrost State	Off	
--- Tc Temp Ave	-150.0 °C	

Supported Danfoss Parameters to enable Adaptive Defrost functionality

The table below gives an overview of the defrost parameters required for the adaptive defrost start co-ordination. **Before configuring any adaptive defrost scheduling please check that the case controls used in your application are compatible**

Parameter	Description
Manual defrost start	Used to start a defrost cycle on a case controller. If this parameter is set ON the case controller will always initiate a defrost cycle. (Few exceptions does exist e.g. if Main Switch is set OFF, Defrost control is not Enabled, Case cleaning is ongoing, Case is in shutdown mode, forced closing condition with disabled defrost).
MC defrost start	Also a defrost start signal, but this signal will not initiate a defrost cycle if the adaptive defrost function in the case controller allows to skip the scheduled defrost. If the case controller is not set up for adaptive defrost, the signal will initiate a defrost cycle.
Request defrost	If the case controller is setup for adaptive defrost skip functionality, this parameter indicates whether the controller will initiate the next scheduled defrost. ON: Case controller will initiate a defrost cycle if the MC defrost start signal is set ON. OFF: Case controller will skip the next defrost cycle if the MC defrost start signal is set ON and the skip defrost counter will count 1 up.
Defrost state	Parameter that indicates the actual defrost status of the controller. This parameter is already used by the standard defrost co-ordination function in AK-SM850.
Tc mean	Filtered condensing pressure (converted to saturated temperature) read by AK-SM 850 from the associated suction group In pack controller) and distributed/written to the case controllers every 10 minutes. If the signal is not updated every 15 minutes in the case controller, the value will fall back to a default value.

Methodology of adaptive defrost

The following section describes the methodology of adaptive defrost.

When the defrost schedule reaches a defrost initiation time the following will happen for **each subgroup of controllers**;
AK-SM 800 will read if any of the case controllers are requesting a defrost cycle. The "Defrost request" status can be read from all case controllers supporting adaptive defrost with skip.

If just one controller requests a defrost cycle, AK-SM 800 will start a defrost cycle on all case controllers of the sub group in question by setting the "Manual defrost start" parameter to ON.

If none of the case controllers are requesting a defrost cycle, AK-SM 800 will send a "MC defrost start" signal to the case controllers of the sub group in question. The reason for sending the "MC defrost start" parameter is to enable the case controller to count the number of skipped defrost.

Exception handling

If a case is not configured for adaptive defrost or has no adaptive defrost function, it will always execute a defrost, members in the subgroup will also be (forced) into defrost. In this situation, all case controllers must start a defrost cycle. If the defrost request signal cannot be read from one or more case controllers at the time of defrost initiation, AK-SM 800 will start a defrost cycle on all case controllers in the sub-group by setting the "Manual defrost start" parameter ON.

Process diagram

The diagram below shows the process for defrost initiation for each sub group of controllers.

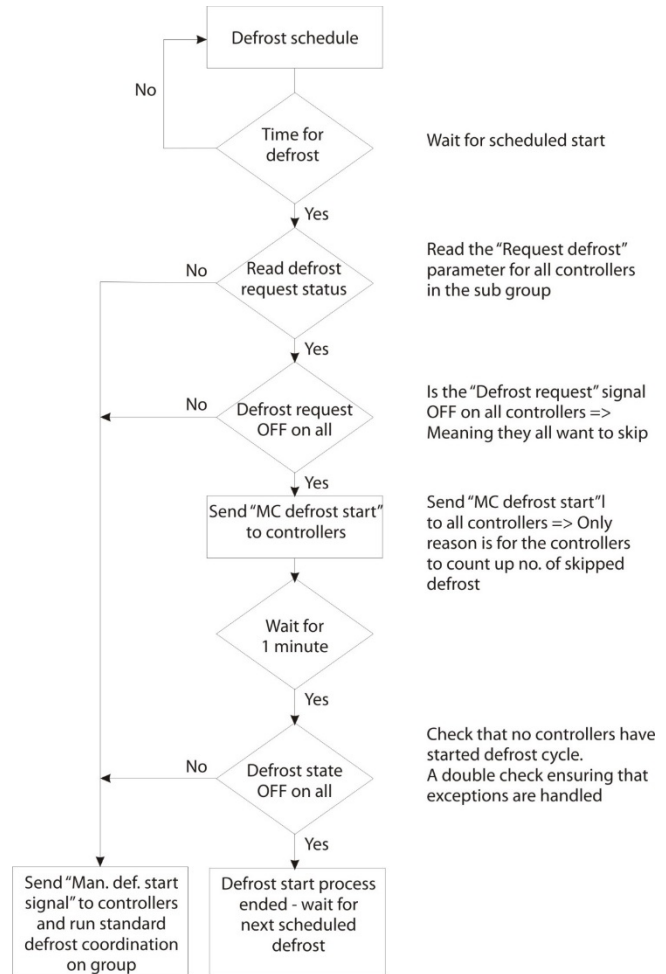

Coordinated Adaptive Defrost schedule and sub-grouping of controllers

Setting up an (coordinated) adaptive defrost schedule

Prior to any defrost schedule configuration, it is required that the relevant case controls are configured to accept adaptive defrost (i.e. set controller d21 AD Mode =4).

Under the Configuration>Control>Refrigeration>Schedules tab, create a new schedule – type Adaptive Defrost.

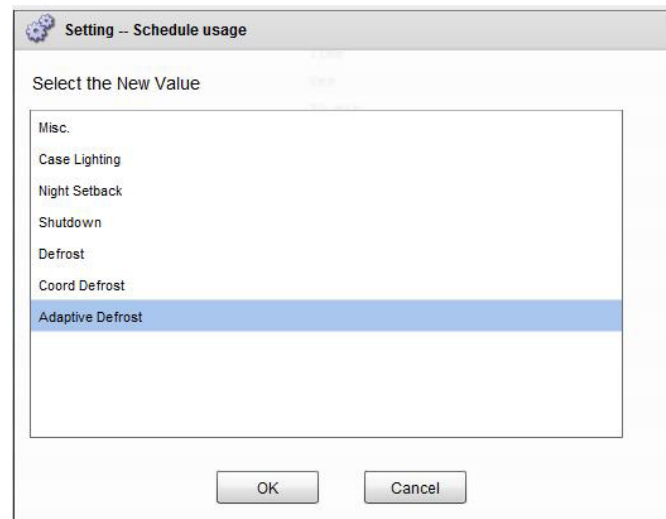

Selection of adaptive defrost schedule

The next step is to associate select case controllers to the (Adaptive) defrost schedule. Next, group the controllers into sub groups, corresponding to case controllers that share same airflow in the refrigerated cabinets.

The reason for putting controllers into sub groups is to maximize the defrost savings – i.e. 3 controllers are more likely to agree upon skipping a defrost cycle than 8 controllers.

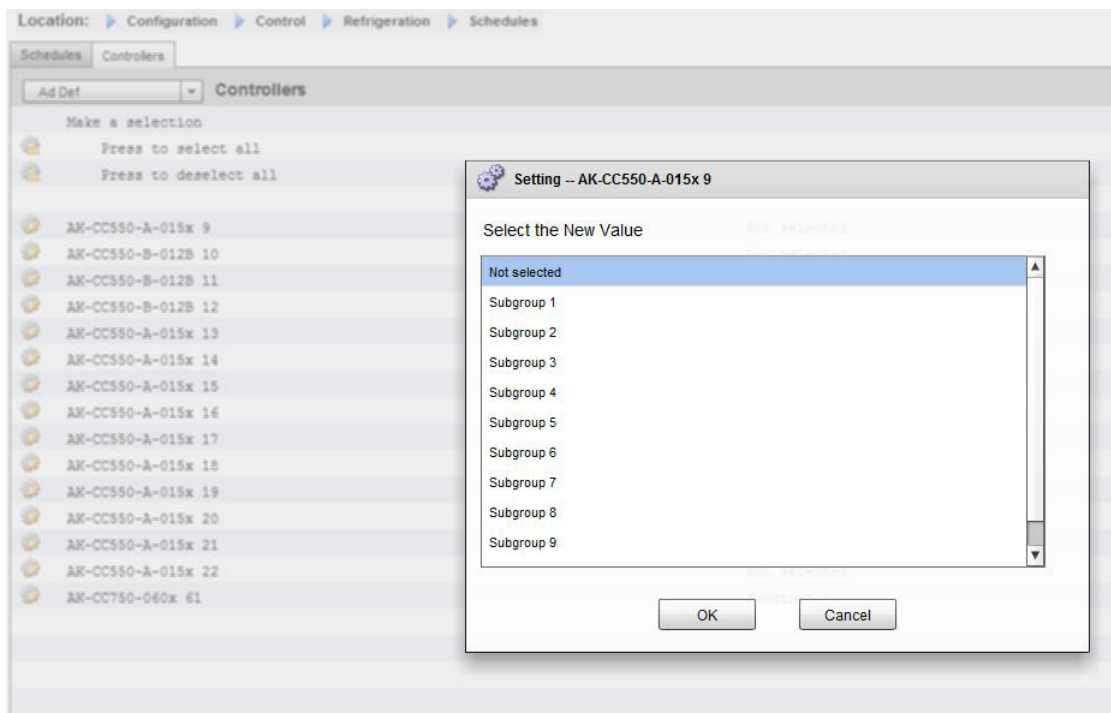

Example:

An island of refrigerated cases consists of totally 8 case sections (evaporators) – 3 case sections on each side and two individual end sections. In this example the user must be able to divide the group of controllers into 4 sub-groups:

Sub group 1: 3 case controllers on one side

Subgroup 2: 3 controllers on the other side

Subgroup 3: End section

Subgroup 4: End section

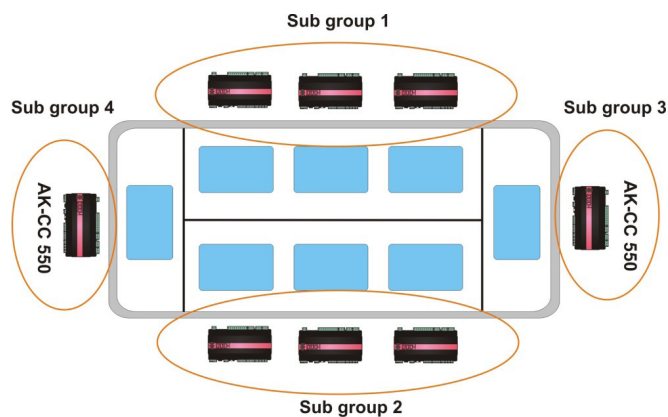

To support this configuration a master 'Adaptive Defrost' schedule is defined, with the controllers then getting grouped together using the sub-group option. This grouping effectively provides the coordination feature so that all cases are in sync during defrost / refrigeration cycles.

Manual defrost

The user can manually start a defrost at an individual case level (via device detail screen>Manual tab) or a schedule wide command can be performed. To initiate a schedule wide (all controls associated with that particular master defrost schedule) navigate to the schedule screen (Configuration>Control>Refrigeration>Schedules) and double click or press the 'turn on now' action line. The status 'defrost group' will then be shown under this schedule screen.

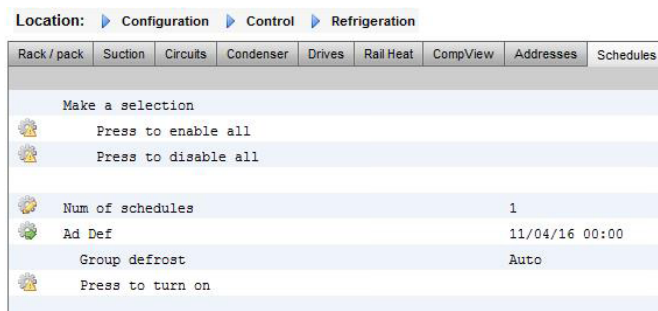

Boolean Logic / Calculations

Calculations

Miscellaneous calculations are used to create custom logic. The AK-SM has the capacity for a total of 96 calculations which can be used to 'drive' miscellaneous logic where special applications are required. There are several ways to formulate calculations for a given requirement, but testing as you go is a 'must' in order to confirm desired results. A calculated point created here can be used anywhere a board & point address can be referenced. The calculated points processor is a true boolean processor, with a full complement of argument types and operators. Every configured calculated point will be listed. The fields are as follows:

New Calc

When first entering the calculations screen a line called New Calc is shown. To configure a new point, double click this field.

Description

The type of point (OI or SI). If an SI, the description will usually include the units.

Point

(Ca-01 to Ca-96) The name of the calculated point.

Value

The current value or state of the point. This will be on or off for OI points, and a value for SI points.

Status

(Online, Offline, Error)

Example of Calculations Tab

Calculations			Ca-01
Point Description	Value	Status	

Double click to add new calculation

After adding a new calculation, a default screen will be shown (similar to the example below). The screen is divided into three areas, which from top to bottom are the following:

Heading area The heading of the screen tells what type and style of calculation point will be created.

Data definitions area This area contains information that identifies points that will be used in the logical statements in the next area, and the current value of each. The area by default has lines for two definitions, but it can be enlarged by double clicking the *****Press to insert new line*****. You will see this done in a few pages during the presentation of our first example.

Rules area This is the area that will contain the logical statements that determine whether the point is on or off (OI) or the value (SI) that is used. At the bottom of the area is the current value of the result.

The screenshot shows the 'Calculations' configuration screen with three dialog boxes on the left and labels on the right. The main screen is titled 'Calculation' and shows a table with the following fields:

Name	Value
Units	OI
Style	Generic
Description	
Datapoint type	RO1 (?error)
Output	Not configured
Datapoint type	
***** Press to insert new line *****	
if (First True line)	Result
RO1	Off
New	
True	On
Current Value (? = Error)	? On

Labels on the right side of the screen:

- Heading**: Points to the Units, Style, and Description rows.
- Data Definitions**: Points to the Datapoint type and Output rows.
- Rules Area**: Points to the logical statement section (if (First True line) ...).
- 'Else' line**: Points to the Current Value row.

Dialog boxes on the left:

- Setting - Units**: Shows a list of units (OI, SI, etc.) with 'OI' selected.
- Setting - Style**: Shows a list of styles (Generic, Clone, Schedule, CallOut, Latch, Receive) with 'Generic' selected.
- Setting - Datapoint type**: Shows a list of datapoint types (RO, OI, VO, SI, SI Bar, SI T, SI %) with 'RO1' selected.

Simple Calculation example:

Calculate the average of 3 different temperature sensors. Show this resulting average value in a miscellaneous sensor driven by the calculation

1/ Creating the miscellaneous points for this calculation- Sensor inputs:

Create 3 sensor inputs (the 3rd is used to display the average through the calculation).

Misc	
No. of relay outputs	1
No. of sensor inputs	3
No. of on/off inputs	1
No. of variable outputs	1

2/

Location: Configuration > Control > Misc > Calculations

Calculation

Ca-01 Calculation

Name	Value
Units	SI °F
Style	Average
Description	Average 2 Sensors
Datapoint type	SI1 (26.1°F)
Input	01-1.1 Sensor 1
Datapoint type	SI2 (36.7°F)
Input	01-1.2 Sensor 2
Datapoint type	Avg3
SI1 SI2	(31.4°F)
Datapoint type	
***** Press to insert new line *****	
if (First True line)	Result
New	
True	Avg3
Current Value	31.4°F

Location: Configuration > Control > Misc

Sensors

Sensor 7 Sensors

Name	Value
Name	Sensor 7
Bd-Pt	Ca-01
Broadcast	No
Type	Ca1c (°F)
Number of alarms	0
Sensor fail alarms	Disabled

MISC

Retrieving data... Unit 0.4

Unit	Name	Value	Alarm
0	Sensor 1	Off	No
0	Sensor 1	26.1°F	No
0	Sensor 2	36.7°F	No
0	Sensor 3	20.3°F	No
0	Sensor 4	29.0°F	No
0	Sensor 5	21.3°F	No
0	Sensor 6	0.0°F	No
0	Sensor 7	31.4°F	No

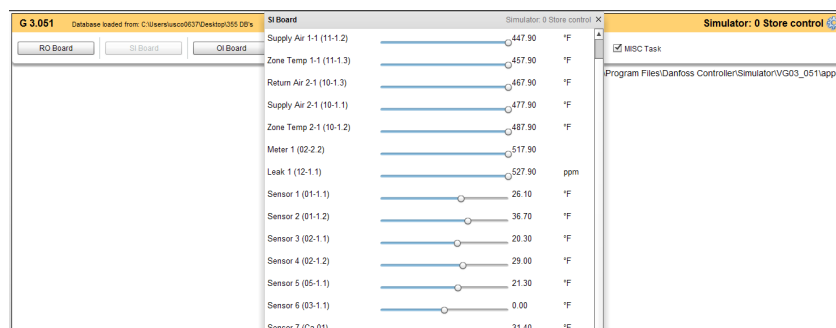

Energy Configuration

Location: Configuration Control

Control Refrigeration Misc Energy Leak Override Light HVAC



Configuration -> Control -> ENERGY

The AK-SM system can monitor Danfoss-approved energy meters which have a network interface. In addition to the network meter models, pulse inputs can be fed from a wide range of non-supported meters to AK I/O pulse boards & thus basic kWh monitoring can be done. Once either a supported meter or pulse input has been configured, the AK-SM can display current electrical status and log data for history purposes. In addition to viewing and recording electrical data, demand limiting can be performed on lighting and HVAC loads.

The AK-SM system can have a max of 80 meters, only **one** of the meters connected to an AK-SM can be used for demand limiting. The following section describes the configuration of Pulse and network meter types, and highlights the demand limiting function.

The Danfoss approved power meters can be seen when selecting meter type under the control question in Configuration->Control page and are described in the example below.

Configuration -> Control -> ENERGY [Pulse input from meter]

From the Configuration->Control page, navigate to the **Energy** tab. This example will describe the configuration of a **Pulse** meter type. Choose this 'type' if a non supported power meter has a pulse output that can be connected to a pulse AK I/O module (AK-XM 107A).

Under the **Meter Setup** tab the following screen can be seen;

Location: Configuration Control Energy	
Type Setup	
Type	
Name	Value
Meter 1	Pulse
Meter 2	WN Plus/MB
Meter 3	VER_EH8035-001x H8035
Meter 4	CG_EM24AV5-001x EM24-AV5

Detailed configuration is done under the Energy tab (Configuration->Control->Energy)

The initial meter configuration is done under the Configuration->Control page. Define how many Meters are required, then select meter type..

Energy meter choices:

Pulse/Vol = used to record volume via pulse (set to Liter, Gallon, Cubic meter (m³), Cubik feet (ft³))

Pulse = Output from meter fed in to AK I/O module

WN Plus= WattNode + brand meter (supplied by Danfoss).

CG_EM24AV0, AV5,AV6,AV9 = Carlo Gavazzi EM24 (Note NOT compatible with other Modbus nodes on network)

VER_EH8035/36 = Veris modbus meter

Carlo Gavazzi WM30AV5 is compatible with other Modbus devices on the same Modbus network

Location: Configuration Control Energy	
Type Setup Demand Response Addresses Alarms Copy Upload Download Import	
Meter 1 Setup	
Name	Value
Name	Meter 1
Window size	15 min
Watt-hours per pulse	1000
Collect History	Yes
Use unit for demand lim	Yes
Window size	15 min
Normal load 01 HRS	1000
Normal load 02 HRS	1000
Normal load 03 HRS	1000
Normal load 04 HRS	1000
Normal load 05 HRS	1000
Normal load 06 HRS	1000
Normal load 07 HRS	1000
Normal load 08 HRS	1000
Normal load 09 HRS	1000
Normal load 10 HRS	1000
Normal load 11 HRS	1000
Normal load 12 HRS	1000

Meter **Setup** Tab. All meter types can be seen in this window. In this example, pulse meter has been selected.

Enter custom name for meter

If using the pulse meter input for demand limiting, answer 'yes' to the question 'use for demand limiting'

See descriptions below for further details

Name: Enter custom description for meter

Window Size: [Visible only when demand limiting set to yes] The window width is set to 15, 20, or 30 minutes. Every minute, the window “slides” forward so that it always contains the most recent period of time. Each minute the accumulated KW during that minute is recorded.

Watt-hours per pulse: Enter relevant value- Watt-hour per pulse

Collect History: Select yes to collect history from this meter

Use for demand limiting: Whether or not this meter is to be used for demand limiting.

Normal Load 01 - 24 Hrs: Enter the upper demand limit you do not wish to exceed for the given hour of the day (defined by each hour line) under normal operating conditions (when using normal power). There is one field for each hour of the day, from 01 to 24.

Maximum Emergency Load: Enter the upper demand limit that you do not wish to exceed when the emergency generator is running.

Start Shedding at: Enter the percent of maximum load at which you want to start shedding loads.

Start restoring at: Enter the percent of maximum load at which you want to start restoring loads which have been shed.

Enable coupling switch: In installations where there are two transformers and/or two emergency generators, a coupling switch can be used to connect both loads to one source in case the other source fails.

Number of normal steps: The number of steps (levels) which you will allow to be shed under normal conditions.

Number of emergency steps: The number of steps (levels) which you will allow to be shed when the emergency generator is running.

Normal:

Soft start begin level: 0 to the number of normal steps set above, up to 10; if 8 normal steps are configured, for example, the upper limit of this entry is 8) This entry specifies the level down to which loads will be turned on when the emergency generator starts. A level will be added each minute unless the specified emergency load for shedding to start is reached.

Couple begin level: [Visible when coupling switch = yes]

Emergency generator control - Enter the upper demand limit you do not wish to exceed for the given hour of the day under normal operating conditions (when using normal power).

There is one field for each hour of the day, from 00 to 23. This screen has two pages in order to list all the hours of the day.

Emergency:

Soft start begin level: [Emergency generator control] 0 to the number of emergency steps set above, up to 10; (if 8 emergency steps are configured, for example, the upper limit of this entry is 8) This entry specifies the level down to which loads will be turned on when the emergency generator starts. A level will be added each minute unless the specified emergency load for shedding to start is reached.

Coupling begin level: [Emergency generator control] Enter the upper demand limit you do not wish to exceed for the given hour of the day under normal operating conditions (when using normal power). There is one field for each hour of the day, from 00 to 23. This screen has two pages in order to list all the hours of the day.

Note about soft starts

The effect of a soft start is to slowly add load to the generator after it starts. If, for instance, soft start begin level is set to 6, when the generator starts only refrigeration loads and loads assigned level 7 through 11 will be on. After one minute, if the load is below the “start shedding at” percentage of maximum emergency load, level 6 will be turned on. After another minute, the same decision will be made for level 5, and so on down to level one. If at any time the load reaches the “start shedding at” percentage, load shedding will begin again until the system reaches the “start restoring at” percentage.

DEMAND LIMITING TAB (see dedicated section on Demand Limiting)

ADDRESSES

Configuration->Control->Energy->Addresses

After the relevant Energy control questions have been configured, appropriate AK I/O addresses need to be set for the pulse meter input. The address input corresponds to the Board & Point address of the AK I/O module - **only use module type AK-XM 107A for pulse meter inputs**. Navigate to the **Addresses** Tab (Demand limiting will be shown in later section). Enter appropriate Board & Point location for the pulse input, under the Sensors tab (as shown below).

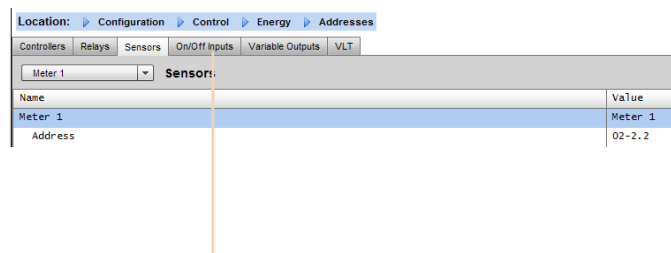

Enter custom name for pulse input

Enter unique Board & Point address. This input address should have the pulse input (via the power meter) connected

Any Emergency or Coupling Switch (defined in meter setup) will require address configuration.

Add these relevant address's via the On/Off Input tab

Configuration -> Control -> ENERGY [Danfoss Supported Power meter]

As previously described, the AK-SM offers communication support to the WattNode +, Veris and Carlo Garvazzi EM24 power meters. These meters offer increased parameters that can be viewed and logged in the AK-SM.

Note- due to differing baud rate specifications the Carlo Garvazzi power meter should not be connected on the Modbus channel if an existing network of Danfoss EKC modbus devices is established.

- **WattNode[®] + (Continental Control Systems)** meter requires LonWorks[®] FTT10 interface - Use Danfoss (part #TP78-02) TP78 to FTT10 network bridge to allow correct communications.
- **WattNode[®] + Modbus (Continental Control Systems)** meter, connects over the AK-SM modbus network
- **Carlo Garvazzi EM24** supported meters have built in Modbus communications - connect directly to the AK-SM Modbus port.
- **Veris EH35/36 (Veris Industries[®])** Modbus energy meters

WattNode Plus (Modbus power Meters)

The Wattnode modbus power meter (Danfoss code 080Z2146) is a device which is compatible with other approved modbus devices on the AK-SM 800 network.

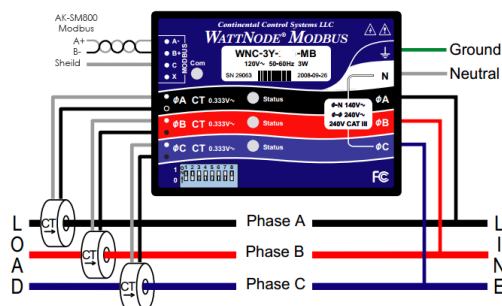

The following steps must be followed to ensure correct scan and communications

Step 1:

Ensure all devices on the modbus network are connected and have a valid and unique network address. Via the Configuration / Network Nodes screen, perform a network scan, enabling the MODBUS-RS485 - Ensure SLV/ECFan is set to NO.

Note: The WattNode Modbus meter (080Z2146) has the ability to run at 38400 or 19200 baud rates. Out of the box the meter is set to 38400. If there are no SLV devices on the network, perform a network scan without selecting the SLV options. This will allow the AK-SM 800 to scan at the same baud rate and thus the meter will be detected.

If you have SLV devices on the same field bus as the meter you need to first communicate with the meter at 38400, then once scanned you select the SLV option to 'yes' and re-scan. This will then set the meter to the slower rate of 19200, the same as the SLV, thus making them compatible on the same field bus.

Modbus Port on AK-SM

RS485 / Modbus Port on Carlo Gavazzi Meter



Carlo Gavazzi ® power meter configuration (used in junction with RS485 AK-SM Model)

The following section describes the required steps to connect & configure the Carlo Gavazzi EM24xx meter over a modbus network connection.

Before any configuration can take place, ensure the meter is securely wired, has a valid network address (different from any other nodes on the 'Controller' network) and has a baud rate set to 9600- consult the meter manual for specific information on how to set the network address & baud rate. The data format is 1 start bit, 8 data bit, no parity and 1 stop bit.

Once set, ensure correct interconnection to the RS485 modbus port on the AK-SM.

(1) To avoid errors due to the signal reflections or line coupling, it is necessary to terminate the bus at the beginning and at the end (inserting a 120 ohm 1/2W 5% resistor between line B and A in the last instrument and in the Host interface).

(2) The network termination is necessary even in case of point-to-point connection and/or of short distances.

(3) For connections longer than 1200m a signal repeater is necessary.

Once all communication wiring has been set, perform a network scan- details of how to perform network scans can be seen in the **Network Nodes** Section of this user guide. Ensure Modbus channel is checked in the Node Overview page.

Configuration -> Control -> ENERGY [Danfoss Supported Power meter]

This example highlights a Danfoss supported meter **WattNode + Modbus**. Having already defined the power meter as 'WN Plus/ MB' under the control page, navigate to the Configuration->Control->Energy page. Under type, select WattNode MB (Modbus).

The physical connection to the Modbus network should keep the polarity (+ terminal should be to the + terminal on the Wattnode)

Name: Enter custom description for meter

Amperage: Select the amperage of the CT's connected to the Wattnode +.

Collect History: Select yes to collect history from this meter

Power Update: Interval to which power is measured.

Energy Update: The interval over which energy (the integral of power over time) is calculated.

Reactive Update: The interval over which reactive components are recalculated.

Demand Period: The interval over which demand is calculated. Demand is defined as average power over a specified time interval.

Demand Subintervals: The # of divisions of the demand period used when calculating a "rolling demand" using a "sliding window."

After the relevant Energy control questions have been configured, the meter must have the address correctly configured. To add the WattNode + modbus meter to the AK-SM network, ensure all network wiring is in place and that power has been applied to the WattNode + meter. Navigate to the addresses tab and then enter the same address that is already set in the meter. Perform a network scan to bring the WattNode + meter on line.

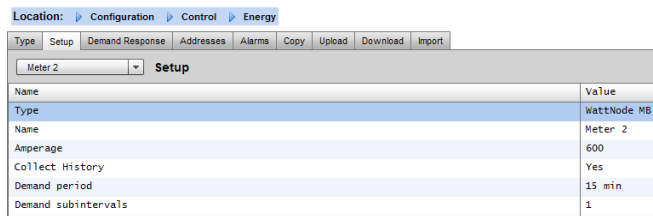

Using the drop down list, the WattNode + meter has been selected.

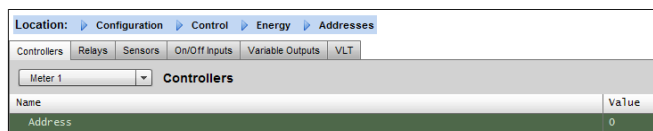

Select the address tab to enter the address which has been assigned in the Wattnode meter (bit switches)

Remember to correctly wire and use the appropriate modbus port on the AK-SM.

Detail -> Energy

Under detail -> energy the Sm8xx supports following information to the user:

1. Status

- a. total consumption since start
- b. Current power in kW
- c. Peak power in kW

Status	Settings	Service	Consumption	
kWh Consumption				27801.0
Current kW Load				60.0
Peak kW				84.0
Occurred				27/11/15 11:59

2. Settings (example shows pulse meter)

- a. Name
- b. Window size for demand limit
- c. Pulse rate in Wh/pulse
- d. Collect history (yes or no)
- e. Use this meter for demand limitation

Status	Settings	Service	Consumption
	Name		Test minute pulse
	Window size		15 min
	Watt-hours per pulse		1000.00
	Collect History		Yes
	Use unit for demand lim		No

3. Service

- a. Reset kWh
- b. Reset peak

Status	Settings	Service	Consumption
	Press to reset kWh counter		
	Press to reset peak kW value		

4. Consumption (to present consumption and peak from history)

- a. View total, monthly, weekly or daily values
- b. Select time frame
 - i. Total from/to
 - ii. previous month and next month
 - iii. previous week and next week
 - iv. previous day and next day

In case of total view it is possible to delete history for this particular meter

Status	Settings	Service	Consumption
	View		Total
	First Day		07/11/15
	Last day		21/12/15
	Total Days		15
	Total kWh		9330.0
	Avg Daily kWh		622.0
	Peak kW		68.0
	Occurred		16/12/15
	Delete history for this meter		

Enterprise Load Shed (via Danfoss EDS Service)

Your AK-SM has built in functionality to facilitate enterprise demand limiting, via the Danfoss Electronic Delivered Services (EDS) offering.

Contact your local Danofss sales rep for more details

The term Load Shed in the AK-SM is used to describe a function that allows an enterprise connection to schedule and actively turn off / on configured electrical loads for a period of time.

Once locally configured, your AK-SM can be fully managed via the Danfoss EDS (Electronic Delivered Services). Once logged on, the demand response enterprise dashboard allows retailers to participate in demand response incentive programs via a single, web-based portal. All site configuration, job scheduling, execution, status monitoring, and meter data extraction is completed from one web application.

Why Demand Response?

Participate in demand response programs.

Quickly curtail energy usage across your enterprise.

Single web portal for all configuration, execution, and utility reporting. For further details, contact your local Danfoss representative.

Minimum requirements:

AK-SM version V08_001 or higher of firmware.

A connection between customer stores and Danfoss EDS –via VPN connection.

Configuration

This section will focus on the local (AK-SM) configuration, and assumes some HVAC and Lighting have been previously configured. The available load Shed Points (**HVAC, Lighting Zones, Misc**) are configured within the AK-SM. From the Configuration/Control/Energy/Demand Response screen select the **Load Shed** tab. Any previously configured HVAC, Lighting or Misc Relay will be visible.

The example below shows the HVAC and Lighting sections. The two HVAC units are shown and a load shed index of '4' has been entered. The available index range is from 0-4 and once set in the AK-SM is used in the enterprise service to dictate what level of load shed the scheduled job (via the enterprise) will execute. The Lighting tab has been set to load shed level index 3

Location: Configuration Control Energy Demand Response Load Shed

HVAC	
Name	Value
Unit 1	
Load Shed Level	4
Power Rating	25.0 kW
Post delay	1 m
Unit 2	
Load Shed Level	4
Power Rating	20.0 kW
Post delay	3 m

Enter load shed index (0-4)

The power rating slot can be used as a note to what the load is. This has no functional purpose except for notification purposes

Enter a required post delay. This ensures once the load shed event has finished not all system loads will start up at the same time, which could result in electrical overload conditions

Location: Configuration Control Energy Demand Response Load Shed

Lighting Zones	
Name	Value
Zone 1	
Load Shed Level	3
Power Rating	0.0 kW
Post delay	0 m

Results

Now the AK-SM has been set for load shed, with the appropriate levels set, the enterprise user can now schedule load shed jobs. Once logged in to the Danfoss enterprise dashboard the user can select multiple sites and select a time and duration, with a load shed level action.

In our example above, if the enterprise user wishes to reduce maximum load for a period of time, a job would be created in the enterprise dashboard and the index '4' would be issued to all selected AK-SM units across the customers estate. The effect is that ALL applications that have an index of 4 and below will turn off for that period of time (and re-start after any post delays). The result in our example here is that all HVAC and lighting will switch off. Another example would be using the load shed index of 3. This would then only shut down ALL applications set at 3 and below. In this example that would be the Lighting, the HVAC would continue to operate.

Demand Limiting

The AK-SM Demand Limiting function is based on a designated utility power meter. Only one meter can be assigned Demand limiting, even though up to 80 meters can be connected to the AK-SM. Once a meter has been selected, the Demand Limit function can be applied against any Lighting and HVAC load.

Utility demand is monitored every minute. Every minute, the most recent *n* minutes are averaged (where *n* is the width of the configured window, 15, 20, or 30 minutes defined in the meter set up window Configuration->Control->Energy). If the average reaches the configured "start shedding at" percentage of configured maximum demand, Step one (all lighting zones and HVAC units assigned to level 1) will be turned off. After one minute, when the average is calculated again, if the demand is still above the configured percentage of configured maximum demand, level two will be shed, and so on. When demand has dropped to the "start restoring at" level, the last level shed will be restored, and then the others in descending order, so that the last load restored will be the one which was shed first. Restoration will continue as long as the load remains below the "start shedding at" percentage.

If both normal and emergency load limits are to be established, the relative on/off input for the automatic transfer switch must be wired and configured. In addition, if the site has a coupling switch, you must wire and configure an on/off input for the coupling switch.

Priority Levels (normal conditions)

Levels are shed in ascending order: level 1, then level 2, and so on up to the highest level configured, limited by the number of steps allowed. Levels above the number of steps configured will not be shed unless the meter configuration is changed (Configuration->Control->Energy meter setup). Since there are only up to ten steps, loads assigned level 11 will never be shed. It is recommended that loads which are not to be shed are left at level 11, the default value.

Emergency level

The priority for shedding when the emergency generator is running. If a load is assigned level 0 (zero) for either normal or emergency conditions, the load will never come on under those conditions.

Configuration->Control->Energy Demand Limiting

As previously mentioned the Demand Limiting function is applied against HVAC and Lighting loads. This example assumes that both HVAC and lighting have been defined in the AK-SM and that a meter has been selected for Demand Limiting.

Navigate to the Demand Limiting tab. The HVAC and lighting systems will be seen in this page, allowing the configuration of shed levels.

Location: Configuration > Control > Energy > Demand Response	
Demand Limiting	
Name	Value
Unit 1	
Shed level	10
Emergency level	11
Unit 2	
Shed level	9
Emergency level	11
Zone 1	
Shed level	7
Emergency level	11

Enter the required Shed levels & Emergency levels for the HVAC & Lighting systems.

General navigation, operation and use (via web)

Once your AK-SM has been configured, general navigation and daily use is done via the Dashboard screen. The Dashboard screen acts as the central system home page, where further system details can be reached. The Dashboard and subsequent device screens have been developed to provide an easy to use navigation environment for the user, where typical status and setting can be found.

Connecting to your AK-SM:

Using a standard web browser or your StoreView Desktop application, enter your AK-SM IP address

Note: input is case sensitive

User Name

Password

The factory default User name & password:

User Name: Supervisor
Password: 12345

Dashboard view:

Once the correct user name and password has been entered the Dashboard screen will load. The Dashboard screen will only reflect what your application configuration has been set to. For example, if your application does not have any HVAC configured the Dashboard will not show the HVAC panel. Dashboard panels are automatically generated depending on the configuration, no user action is required to build the panels.



To guarantee the best experience when connecting to your AK-SM, ensure you PC has the latest version of Adobe® Flash®

- Preferences
- Refrigeration Report
- Download Report
- History Log Collection
- Alarm Log Collection
- Log Off

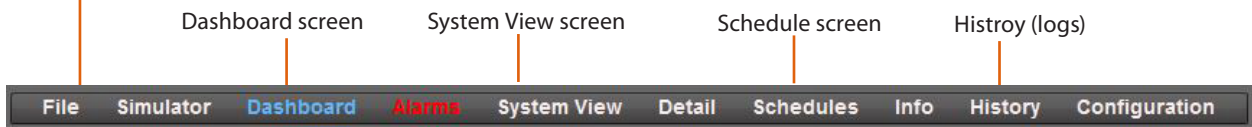

Use the simulator tool to simulate configured Misc points (only available through RMT off line tool)

Global alarms (all connected AK-SM units)

Device detail screen

Info screen (software version, etc)

Central AK-SM configuration screens

Labels above the dashboard: Data poll refresh info, Active alarm panel, Expand panel button, Refrigeration panel, HVAC panel, data communication status

Labels below the dashboard: Lighting panel, Misc panel, Energy panel

Unit	Device Name	Alarm Type	Occurred
0	Zone Temp 2-1	High zone temp	12/20/12 01:57PM

Unit	Name	Status	Value	Setpoint	Alarm
0	Pack 1				No
0	Suction 1	(s15) De	Err	Err	No
0	Circuit AA1	(s0) Non	0. No HA	35.6 °F	No
0	Circuit AA2	(s0) Non	-328.0 °F	35.6 °F	No
0	Circuit AA3	(s0) Non	-328.0 °F	35.6 °F	No
0	Circuit AA4	(s0) Non	-328.0 °F	35.6 °F	No
0	Circuit AA5	(s0) Non	-328.0 °F	35.6 °F	No
0	Circuit AA6	(s0) Non	-328.0 °F	35.6 °F	No
0	Circuit AA7	(s0) Non	-328.0 °F	35.6 °F	No

Unit	Name	Status	Value	Alarm
0	Unit 1	Fan proof fail	72.9 °F	No
0	Unit 2	Fan proof fail	52.7 °F	Yes

Unit	Name	Value	Alarm
0	Zone 1	On	No
0	Relay1	On	No

Unit	Name	Value	Alarm
0	Sensor 1	Off	No
0	Sensor 1	26.1	No
0	Sensor 2	36.7	No
0	Sensor 3	20.3	No
0	Heater On/Off	Off	No
0	Misc VarOut 1	0.0%	No
0	Leak 1	5271	No

Unit	Name	Value	Alarm
0	Meter 1	0.0 kWh	No
0	Meter 2	OHLn 0.0 kWh	Yes
0	Meter 3	OHLn 0.0 kW	Yes
0	Meter 4	OHLn 0.0 kW	Yes

Once the correct user name and password has been entered the Dashboard screen will load. The Dashboard screen will only reflect what your application configuration has been set to. For example, if your application does not have any HVAC configured the Dashboard will not show the HVAC panel. Dashboard panels are automatically generated depending on the configuration, no user action is required to build the panels.



Upon the Dashboard loading, if any active alarms are present the built in alarm buzzer can be heard. To silence the alarm press the silence button. This does not acknowledge or clear any alarms.

File

Preferences

The screenshot shows the 'Preferences' dialog box with the following settings and callouts:

- Home screen:** A dropdown menu set to 'Dashboard'. Callout: "Setup the preferred start screen".
- Show misc items on Dashboard:** A checked checkbox. Callout: "Visualize the Misc section on the dashboard".
- Enable alarm sound:** A checked checkbox. Callout: "Enable or disable sound if an alarm occurs".
- Allow program close/minimize:** A checked checkbox. Callout: "Enable or disable the possibility to minimize or close Storeview Desktop".
- Use full screen:** An unchecked checkbox. Callout: "Enable or disable the possibility to resize or minimize Storeview Desktop".
- Log off after inactivity period:** An unchecked checkbox. Callout: "Logs the user off after a time of inactivity".
- Log on automatically:** An unchecked checkbox. Callout: "Enable or disable the possibility to logon automatically if Storeview Desktop starts. If the function is enabled, credentials are needed."
 - Address:** Text input field containing '192.168.178.70'.
 - User Name:** Text input field containing 'rainer'.
 - Password:** Password input field containing '*****'.
- Analog graph colors:** A row of eight color swatches (blue, green, red, brown, cyan, purple, dark blue, teal). Callout: "Section to customize graph colors for analog and digital lines. Used in displaying history." (This callout also points to the digital graph colors section).
- Digital graph colors:** A row of eight color swatches (teal, orange, blue, tan, brown, olive, purple, light blue).
- Buttons:** 'Save' and 'Cancel' buttons at the bottom.

Refrigeration Report

When selecting the Refrigeration Overview report it is possible to output a current status report of configured refrigeration. The report will display current value, setpoint, alarm, defrost and device address. The report can be exported to PDF, CSV and Print.

It is also possible to export the Refrigeration report to a USB flash drive in simple text format, which is mounted in the AK-SM 800 USB port (user must be authorized).

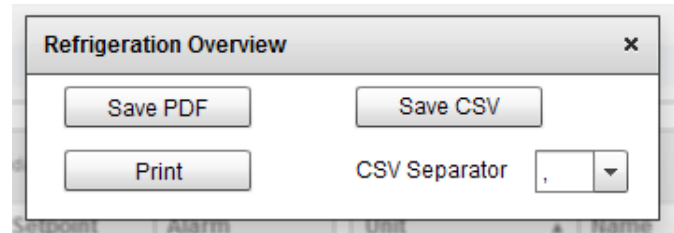





Tue Nov 4 2014 20:01:15

Name	Model	Current Value	Setpoint	Alarm	Defrost	Address
KA1 - Kyl	AK-PC781-041x	-5.6 °C	-5.0 °C	No		3
4-plansd 1K21A	AK-CC550-A-015x	1.0 °C	0.5 °C	No	Off	118
4-plansd 1K21B	AK-CC550-A-015x	2.2 °C	1.0 °C	No	Off	119
4-plansd 1K21C	AK-CC550-A-015x	1.1 °C	1.0 °C	No	Off	120
4-plansd 1K21D	AK-CC550-A-015x	5.5 °C	5.0 °C	No	Off	121
4-plansd 1K21E	AK-CC550-A-015x	5.5 °C	5.0 °C	No	Off	122
4-plansd 1K22A	AK-CC550-A-015x	4.3 °C	5.0 °C	No	Off	123
4-plansd 1K22B	AK-CC550-A-015x	4.2 °C	5.0 °C	No	Off	124
4-plansd 1K22C	AK-CC550-A-015x	3.9 °C	5.0 °C	No	Off	125
6-plansd 1K23A	AK-CC550-A-015x	4.8 °C	5.0 °C	No	Off	115
6-plansd 1K23B	AK-CC550-A-015x	5.0 °C	5.0 °C	No	Off	116
6-plansd 1K34	AK-CC550-A-015x	1.5 °C	0.5 °C	No	Off	110
6-plansd 1K15A	AK-CC550-A-015x	Defr 7.3 °C	5.0 °C	No	on	74
6-plansd 1K15B	AK-CC550-A-015x	4.6 °C	5.0 °C	No	Off	75
6-plansd 1K15C	AK-CC550-A-015x	3.9 °C	5.0 °C	No	Off	76
Manuell Fisk 1K	AK-CC550-A-015x	15.9 °C	0.5 °C	No	Off	46
1-plansd 1K9A	AK-CC550-A-015x	1.8 °C	2.0 °C	No	Off	49
1-plansd 1K9B	AK-CC550-A-015x	3.4 °C	1.9 °C	No	Off	50
1-plansd 1K9C	AK-CC550-A-015x	2.6 °C	2.0 °C	No	Off	51
3-plansd 1K10	AK-CC550-A-015x	6.3 °C	6.0 °C	No	Off	54
Kylr Mejeri 1K2	AK-CC550-A-015x	6.5 °C	5.0 °C	No	Off	22

Download report

It is possible to download a text file which contains all information's of the unit. It is information's about the whole unit setup, alarms, schedules, scanned devices, audit trail and the controller database. If some of the information's is not needed, a setup can be made under Configuration/System/System Report

Location: [▶ Configuration](#) [▶ System](#)

System	Auth Levels	Users	Licensing	System Report	Files
Include in quick report					
	Alarms				Yes
	Schedules				No
	Scanned devices				No
	Audit Trail				No
	Controller database				No

System Report :
 Store Name : Super Store
 Store Id1 :
 Store Id2 :
 Street : Millerstreet 63
 City : 46569 Baltimore
 Phone :
 Mac Address : 00:0B:2D:08:00:17
 Unit Address : 0
 Unit Name : Superstore Unit 1
 Created on : 03/07/14 09:02
 Software Version : G08.020
 Software Created : 14/02/14 10:55
 Factory Application: G08F011
 Boot-loader : 9.3
 CPU Base Board : 2
 CPU Version : MPC5125 V1.0
 CPLD Version : 2
 Dynamic RAM : 256 Mbyte
 MRAM : 512 Kbyte
 Serial Flash : 64 Mbyte ST Device ID 0x76
 Parallel Flash : 64 Mbyte Unknown Device ID 0x7e2301
 RAM Disk : 40 Mbyte 24% Full
 IP Address : 192.168.178.24

 Licensed features:

Refrigeration
 HVAC
 Lighting
 Com-Trol

Auto History Log Collection

The user can create with Store view Desktop a daily or weekly export of Log data. The computer running Store View must be permanently connected to the AK-SM 800 network and remain running in order to auto collect log data.

The file format can be CSV for further use in Excel or other tools or HST to reread the data with Store view Desktop. To export Store view Desktop must be connected to the AK-SM 800.

Select the sample rate for the exported file

Enable/Disable the auto collection Enable auto-collect

Selection of the file format Sample Rate

Separator for CSV (, or ;)

Collection rate daily or weekly

Select the destination folder for the exported files

Select data-points (All selected)

Selection of data points

Conditions, if the frequently export is always used:

1. Add Store view Desktop to the PC auto start section
2. Disable in "Preferences" the log off after inactivity period
3. Enable the auto logon feature and set the credentials

Select Datapoints

Search

- Unit #0 Testunit
 - On-Off Inputs
 - Energy Meter Controllers
 - Relay Outputs
 - AK-CC750 AA2a
 - AKC PC 781
 - AK-CC550
 - AKC114A-PI200
 - Sensor Inputs
 - Others

Auto Alarm Log Collection

The user can create with Store view Desktop a daily or weekly export of alarms.

The computer running Store View must be permanently connected to the AK-SM 800 network and remain running in order to auto collect alarm data.

Export of all alarms or only active, acknowledged or cleared alarms

- Enable/Disable the auto collection
- Separator for CSV (, or ;)
- Collection rate hourly,daily, weekly, monthly
- Select the destination folder for the exported files

Collection rates:

Hourly – no additional setup is needed

Daily – Time stamp is needed

Weekly – Time stamp and day of the week is needed

Monthly – Time stamp and day of the month is needed

Conditions, if the frequently export is used:

1. Add Store view Desktop to the PC auto start section
2. Disable in "Preferences" the log off after inactivity period
3. Enable the auto logon feature and set the credentials

Managing alarms:

Any active alarms will be shown in the Dashboard alarm panel. To view more details regarding the alarm double click the relevant alarm line. A alarm info box will appear with further details regarding the alarm.

In addition to more information, the info box also allows the authorized user to Mute/Acknowledge the alarm and to jump to the device detail screen.

Alarm info pop up

Description	High sensor value
Point	Outside temp
Address	01-1.1
Setting	Alarm if above 122.0°F for 15 minutes
Current Value	497.9 °F
Occurred	12/21/12 09:39AM
Acknowledged	No
Cleared	
Alarm Level	Normal
Alarm Action	0

Name	Status
Network 2	Not selected
Printer	Not selected

Use the Mute/Ack button to acknowledge the alarm. When pressed the alarm will 'move' to the Acknowledge list

Click the detail button to jump to the device detail screen

To view all system alarms (known as global alarms) use the Alarms tab (found on the main menu)

Global alarm screen

Global acknowledge list Status and Service screens

Export Alarms Export to CSV file

Service screen

Under the service screen tab, test alarms can be configured and set.

Name	Value
System Test Alarm	Normal
Action	1
Auto Test	None
Suspend alarm generation	No
Internal relay	Auto

Device detail:

Whilst the Dashboard screen will show basic asset information (AK-SM unit address, Asset Name, Value, Status and alarm), more detailed information can be found by double clicking an asset line in the Dashboard. The resulting device detail screen will reflect more details and settings. The device detail screen is designed to provide key status and operational settings for the selected device. Easy navigation to other assets is done via the navigation tree. The screen image below highlights some of the main areas of the device detail screen.

Navigation Tree

Device alarms/History/Schedules and Advanced View

'Snap shot' history

File Simulator Dashboard Alarms System View Detail Schedules Info History Configuration Help

Refrigeration

Suction 1

- Circuit AA1
- Circuit AA2
- Circuit AA3
- Circuit AA4
- Circuit AA5
- Circuit AA6
- Circuit AA7
- Circuit AA8
- Circuit AA9
- Circuit AA10
- Drive P1-01

Suction 2

Suction 3

HVAC

Lighting

Energy

Miscellaneous

Detail Alarm History Log Schedules Advanced View

Device Detail: Circuit AA1 #0 Store control

AK-CC210-A-023x

Description Circuit AA1

Address 1

Status (s0) Normal

Alarm OK

Setpoint 35.6 °F

Current Value -328.0 °F

12/21/2012 09:40:16 am 12/21/2012 09:00:16 am 12/21/2012 08:20:16 am 12/21/2012 08:40:16 am 12/21/2012 10:00:16 am 12/21/2012 10:20:16 am 12/21/2012 10:40:16 am 12/21/2012 11:00:16 am 12/21/2012 11:20:16 am 12/21/2012 11:40:16 am

Refresh

Status Settings Manual Operation

Summary Status Updated: 12:05:09 PM

Name	Value
* --- EKC State	(s0) Normal
* u17 Ther. air	-328.0 °F
* u12 S3 air temp	-328.0 °F
* u16 S4 air temp	-328.0 °F
* u09 S5 temp	-328.0 °F
* u10 DI1 status	OFF
* h01 HACCP temp	32.0 °F
* u13 Night Cond	OFF

Device Alarms No alarms detected.

Controller group menu (based on the controller type)

Full screen button

Status | Settings | Manual Operation tabs

Status

Under the status tab, common read only datapoints are shown

Settings

Under the settings tab, read and write values can be shown.

Double click a line to make changes (if authorized)

Manual Operation

Under the Manual Operation tab, key user override functions are available

Use the 'Advanced view' screen to access Measurements and Settings side by side. This screen is useful to access all read/write parameters for the particular controller

Advanced screen

File Simulator Dashboard Alarms System View Detail Schedules Info History Configuration Help

Refrigeration

Suction 1

- Circuit AA1
- Circuit AA2
- Circuit AA3
- Circuit AA4
- Circuit AA5
- Circuit AA6
- Circuit AA7
- Circuit AA8
- Circuit AA9
- Circuit AA10
- Drive P1-01

Suction 2

Suction 3

HVAC

Lighting

Energy

Miscellaneous

Detail Alarm History Log Schedules Advanced View

Advanced View: Circuit AA1 #0 Store control

Circuit AA1

Summary Status Updated: 12:03:28 PM

Name	Value
* --- EKC State	(s0) Normal
* u17 Ther. air	-328.0 °F
* u12 S3 air temp	-328.0 °F
* u16 S4 air temp	-328.0 °F
* u09 S5 temp	-328.0 °F
* u10 DI1 status	OFF
* h01 HACCP temp	32.0 °F
* u13 Night Cond	OFF

Settings Updated: 12:03:28 PM

Name	Value
User file	None
Evap shutdown when injection c	Yes
* r12 Main switch	1- Start
* --- Cutout	35.6 °F
* r01 Differential	3.6 °F
* r02 Max cutout	122.0 °F
* r03 Min cutout	-58.0 °F
* r15 Ther. S4 %	100 %
* --- Def. Start	OFF
* d02 Def.StopTemp	42.8 °F
* A13 HighLim Air	46.4 °F
* A14 LowLim Air	-22.0 °F
* u58 Comp1/LLSV	OFF

Device Alarms No alarms detected.

System view:

The system view provides a generic yet graphical view of your configured controls.

The same principle of the navigation tree can be seen in the left side of the screen. The system view screen shows any configured Rack or Pack, with associated evaporator circuits. To see additional information, hover your mouse pointer over an icon, a pop up box will appear showing additional information. To view additional information and gain access to settings click the 'show Detail' button. A dashboard will slide across, where a Status, Settings and Manual operation can be seen. Simply click an asset to highlight and the detail table will update with reference to this selected device. Once complete with the device settings, close the dashboard by clicking the 'Hide Detail' button.

System View (Refrigeration)

Gain access to more details via the 'Show Details' button

The screenshot shows the 'System View' for 'Refrigeration'. The top menu includes File, Simulator, Dashboard, Alarms, System View (highlighted), Detail, Schedules, Info, History, Configuration, and Help. The left sidebar shows a navigation tree with 'Refrigeration' selected, and sub-items: Suction 1, Suction 2, Suction 3, Suction DA, and Suction DB. The main content area is titled 'Suction 1' and contains a 'Show Detail' button. Below this, there is a 'Status' section for 'AK-PC420(1)-012x' with the following table:

Description	Suction 1
Address	100
Status	(s15) Defrost
Alarm	OK
Setpoint	Err
Current Value	Err

To the right of the status table is a 'Compressors' section with an icon of three compressors and the text '(s15) Defrost'. Below the status and compressor sections is a row of ten evaporator circuit icons, each labeled with its ID and temperature:

- Circuit AA1: -328.0 °F
- Circuit AA2: 0.0 °F
- Circuit AA3: 0.0 °F
- Circuit AA4: 0.0 °F
- Circuit AA5: 0.0 °F
- Circuit AA6: 0.0 °F
- Circuit AA7: 0.0 °F
- Circuit AA8: 0.0 °F
- Circuit AA9: 0.0 °F
- Circuit AA10: 0.0 °F

At the bottom left of the interface, there are icons for 'HVAC' and 'Lighting'.

Schedule view:

The schedule view provides a system wide view of schedules (previously configured) in your AK-SM or host of controllers. The following schedules are currently supported under the schedule view;

- Shutdown (Generic controllers - i.e. AK-CC)
- Defrost (Generic controllers - i.e. AK-CC)
- Case Lights (Generic controllers - i.e. AK-CC)
- Night Setback (Generic controllers - i.e. AK-CC)

If a host network of AK-SM units are configured, a full system view can be seen by selecting the folder icon, for a (AK-SM) unit display click the relevant heading under the folder view. The schedule screen includes a mouse hover over, that indicates (per circuit) the schedule times.

Circuit BA2	
Start:	12:30 AM
Start:	05:18 AM
Start:	10:06 AM
Start:	02:54 PM
Start:	07:42 PM

Change the graphical view to text (table) form, Print, save as PDF or save as CSV

The screenshot shows the 'Schedules' view in a software interface. The top menu bar includes 'File', 'Simulator', 'Dashboard', 'Alarms', 'System View', 'Detail', 'Schedules', 'Info', 'History', 'Configuration', and 'Help'. The 'Schedules' menu is active, showing options for 'View Text', 'Print', 'Save PDF', and 'Save CSV'. The main area displays a table of schedules for various circuits (Circuit BA1 to Circuit BA10) across a 24-hour period (12 AM to 11 PM). The table shows blue squares indicating active periods for each circuit. A 'Defrost' icon is visible in the top right corner. At the bottom, there is a 'Schedule Concurrency (10 minute resolution)' bar showing vertical bars representing concurrent schedules.

	12	1	2	3	4	5	6	7	8	9	10	11	12	1	2	3	4	5	6	7	8	9	10	11
Circuit BA1																								
Circuit BA2																								
Circuit BA3																								
Circuit BA4																								
Circuit BA5																								
Circuit BA6																								
Circuit BA7																								
Circuit BA8																								
Circuit BA9																								
Circuit BA10																								

History (Logs)

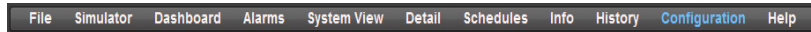

To access your AK-SM history, select the history tab.
Upto 8 datapoints can be viewed at any given time on the history screen.

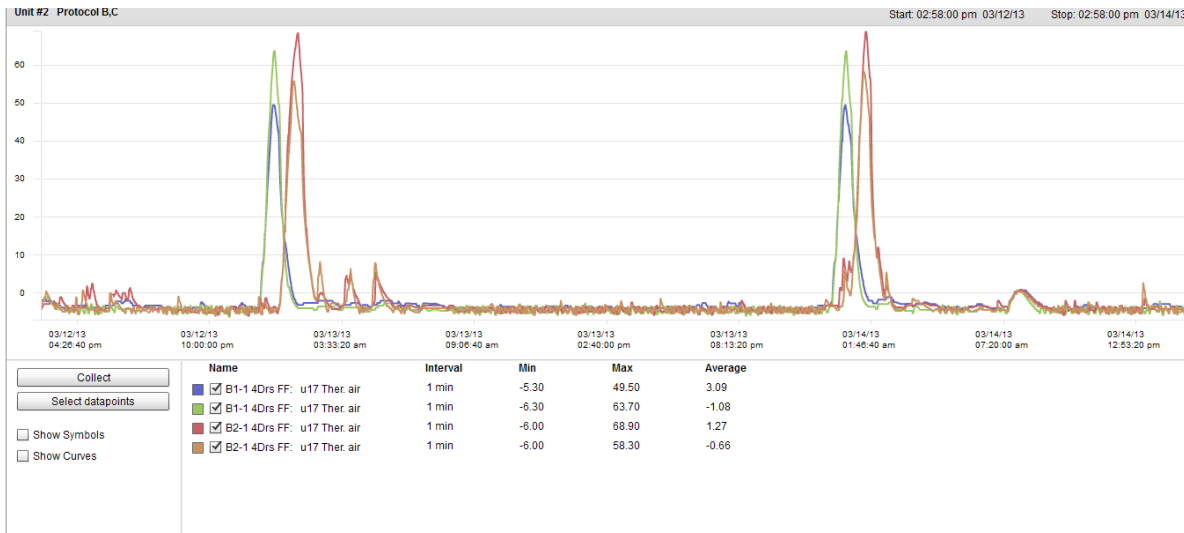

History Tool bar

When viewing data in the history view the tool bar has a set of functions to enable various actions to be performed.

Export history function

Export to .hst or csv file format. Saving the collected history points (as .hst) will allow the user to re-load these at a later date (via the 'load history from file' button)

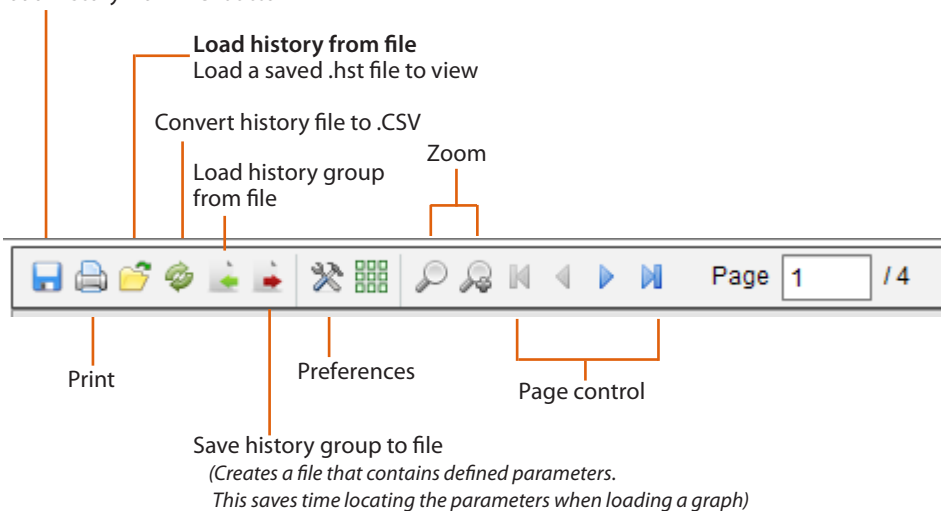

Collecting and viewing history

1/ from the history page, press the collect button

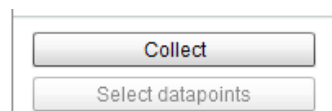

2/ Select the required datapoints and time/date range. Multiple points can be collected but only 8 can be later shown in the history screen at any given time. After the datapoints have been downloaded, a dialogue box will appear which provides two options:

- Select points to draw
- Save to .hst file (for later view)

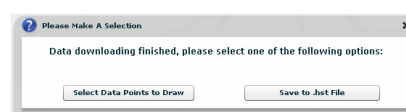
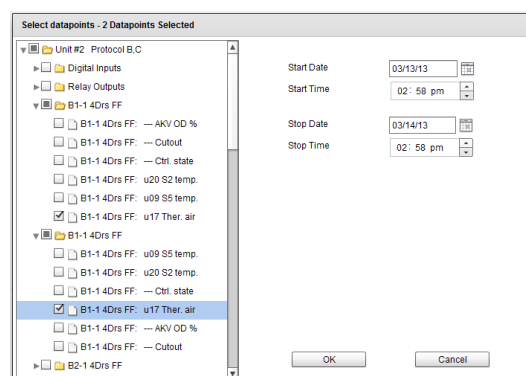

3/ The graph will be presented for view and analysis. Use the zoom buttons or hold the left mouse button and hold for zoom area. Moving the mouse pointer will show a tool tip with point description, time/date and value.

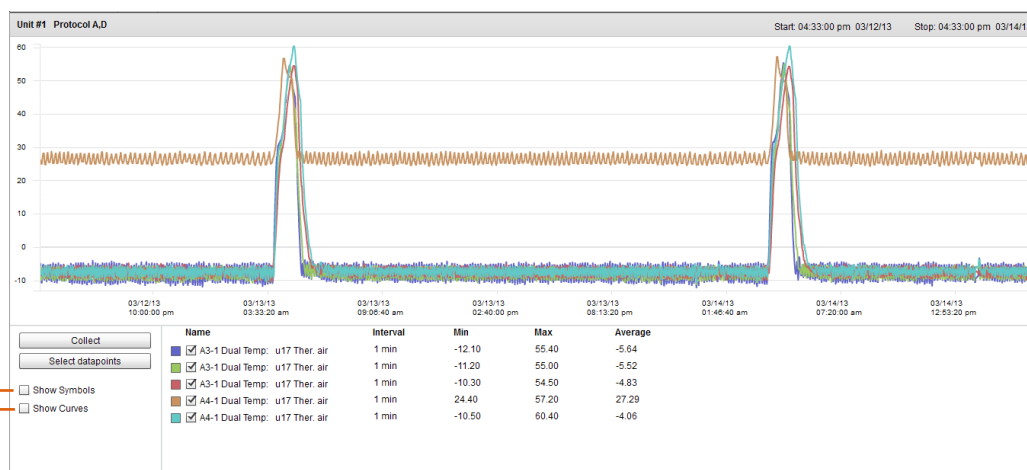

Show curves (provides a computed rounding of the analog curve)

Show Symbols (each symbol represents a sample)

Save History Group to file (saving time for frequent datapoint selections)

This feature allows the user to save a set of history datapoints. Typically this feature would be used when a set of datapoints is frequently needed to be loaded and viewed. Once the datapoints are saved, this history group can then be easily loaded - thus saving time in selecting datapoints.

Load History Group from file

Use this feature to load any previously save datapoint groups. When opening the history group file the system will prompt for the file location. Once loaded a 'select datapoint' box will appear with the datapoints already pre-selection

Export History data

This feature allows the user to export the previously collected history data. A pop up window asks the user to select a file format, the following formats are possible;

- .hst (Danfoss history file format)
- .csv (Excel compatible spreadsheet)

Saving any collected history as a file allows for future loading and view, use the 'Load history from file' button to load any saved history files.

Recommended method for upgrading your AK-SM 800 series front end

AK-SM 800 system software and ED3 files can be found at the Danfoss.com web site <http://www.ak-sm800.danfoss.com>

There are two main software components for the AK-SM 800 series front end, the Bootloader and Factory Application image (FAI). When installing new software updates refer to the associated Refrigeration Note for specific guidance. The section below briefly describes each software package;

Bootloader application (in a Compressed Software Image or .CSI format)

The AK-SM 800 Bootloader software (.CSI) is a critical file that manages system boot up sequence and system management. The Bootloader cannot be loaded remotely. Updating the bootloader can be done in application mode (normal AK-SM 800 operation) or when placed in Bootloader mode (toggle switch behind keyboard).



Factory Application Image (in a .FAI format)

The FAI provides the system application software and can only be installed when running in the Bootloader mode. The FAI contains all the required files for correct system application run time, including all relevant web and EDF files. The FAI file cannot be loaded remotely.

When your AK-SM 800 series front end is used in a host network configuration (multiple units connected via IP), Danfoss recommends updating all units to the same software version.

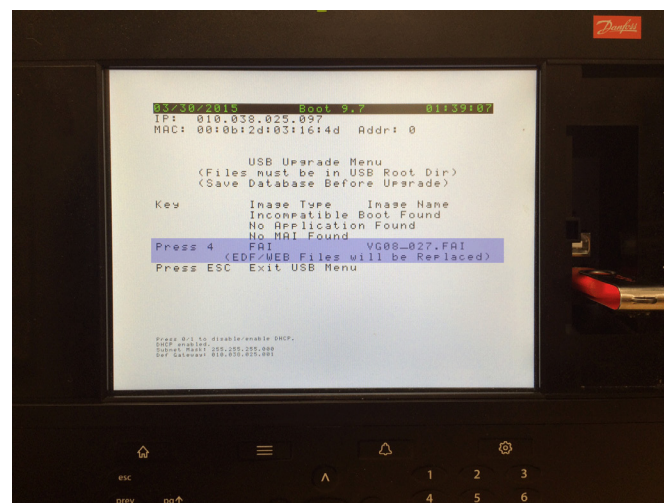

Example of RS485 AK-SM 800 connections (remove keypad to access connections)

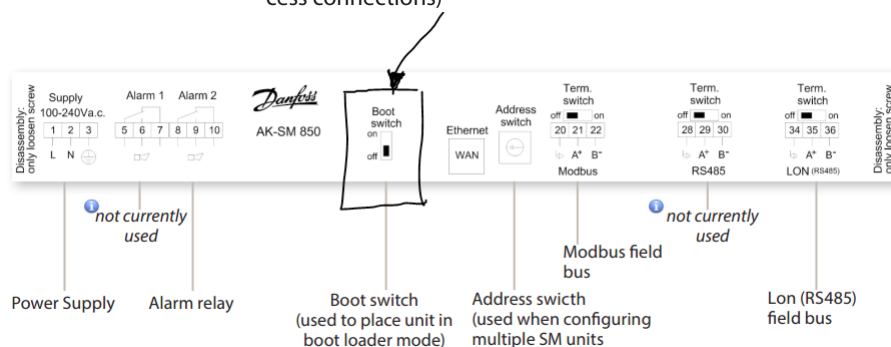

Updating the Bootloader(.CSI) and system application (.FAI) in Bootloader mode

The following workflow describes how to update your AK-SM 800 bootloader and application software. Both Bootloader and FAI are installed whilst your SM 800 is in bootloader mode. Remember to set the Boot Switck to OFF after completing this task.

- 1) Gain Supervisor level access by logging into the SM 800
- 2) Backup the system database before proceeding (insert USB flash drive and option 4, save database)**
- 3) Remove keypad and place Boot switch **ON**. Replace keypad
- 4) Reset SM800 by power off/on or via the soft reset button (push in for 5sec), behind front access door
- 5) SM800 will reset into Bootloader mode- insert USB flash drive and select option 1 to load Bootloader
- 6) After software update, system will reset in Bootloader mode- verify correct software version. Proceed to update application software (FAI).
- 7) Ensure / re-insert USB is connected and select option 4 to load FAI
- 8) System will load FAI and reset (Note! This can take ~20 minutes to complete)
- 9) Remove keypad and place Boot switch to OFF, replace keypad**
- 10) Reset unit, new SM 800 application is now installed

Updating ED3 files

ED3 files are files used by the AK-SM 800 to represent physical devices; typical examples are case and pack controls. The ED3 file allows the user to program offline without having to be connected to any physical device or network. The ED3 files also contain information to support XML information, Optimizations and various device defaults.

Typically each new AK-SM 800 series software release (built into the FAI file) will have new and updated ED3 files. However, during mid release cycle, it may be necessary to load new or updated ED3 files to support new devices used in the field. The text below describes the typical action on how to load ED3 files into your AK-SM 800 series front end.

AK-SM 800 system software and ED3 files can be found at the Danfoss.com web site

<http://www.ak-sm800.danfoss.com>

Instructions for loading new ED3 file(S) from RMT

- 1) Use latest RMT tool and via the 'Log on' screen connect to your AK-SM 800
- 2) Once connected, navigate to the 'File Management' tab (in the RMT)
- 3) In the Remote path screen section, navigate to the \edf folder

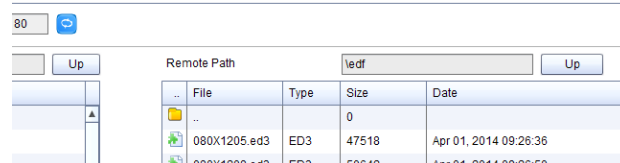

- 4) Select the new EDF's based on your PC, and load/replace into the \edf folder
- 5) Once all EDF's have been successfully loaded, the system will need to be re-set. This can be done manually via the units re-set button or under the RMT 'tools' menu (Reset Unit)

Note1: To ensure the front end database is fully synced with the controllers settings please perform a controller 'Upload' function

Flash Drive options (seen in run time application mode)

Instructions for loading new ED3 file(S) with USB
Copy the ED3 file and the device list to the USB stick and insert the stick in USB port A.

User name and password are required to get the USB menu enabled.

Option 8. allows to upload the ED3 file and option 9. the LS3 file, which is the device list

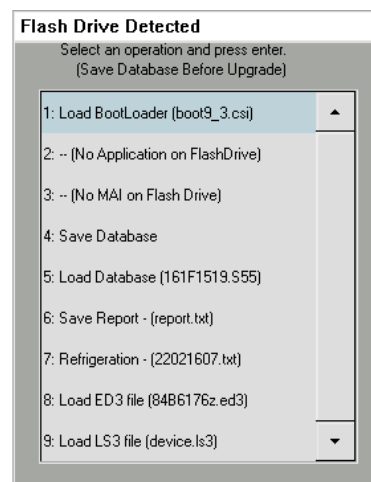

Instructions for loading new ED3 file(S) from USB

Copy ED3 file and (if needed) the device list to the root folder of the USB stick.

Plug in the USB stick into the unit.

Press 8 to upload a ED3 file. Press 9 to upload the device list

- Option 1: The Bootloader file can be updated via USB connection.
- Option 2: Not applicable for the SM800 series
- Option 3: Not applicable for the SM800 series
- Option 4: Save AK-SM database via USB
- Option 5: Load AK-SM database via USB
- Option 6: Save report (txt file format, containing main system configuration details)
- Option 7: Save Report (txt file format, containing configured system status, not full configuration details)
- Option 8: Load ED3 file
- Option 9: Load LS3 file

Device Management (Configuration/System/Device Management)

The purpose of the Device Management feature is to control the amount of active device files at any given time (max 1000), thus saving system RAM and improving system performance.

The updated file management screen are effective with AK-SM 800 software version 8.021.

By default the most common controller types are set to 'Enabled'. Groups which are not enabled (Disabled) are not actively loaded into system RAM. To enable any controller group simply double click the group and from the action menu select 'Enabled'.

As device files are Enabled / Disabled the file counter will reflect the total number of active device files. The term 'Files' in this case, is actually the total number of device selections available. For example, a controller such as an AK-CC 550 has 10 different applications. Therefore each application is a 'selection'. Then the number of selections is multiplied over several software versions that may be available for that device.

The maximum number of active selections per front end will now be 1000

This means that once the controller selection reaches 1000, you will need to disable groups of those devices not being used, in order to keep this number at, or below 1000. A message will be presented to alert if the capacity has been reached.

Using the network scan or Refrigeration layout/scan wizard will automatically enable any group is detected on a scan (even if the device file was previously set to 'disabled').

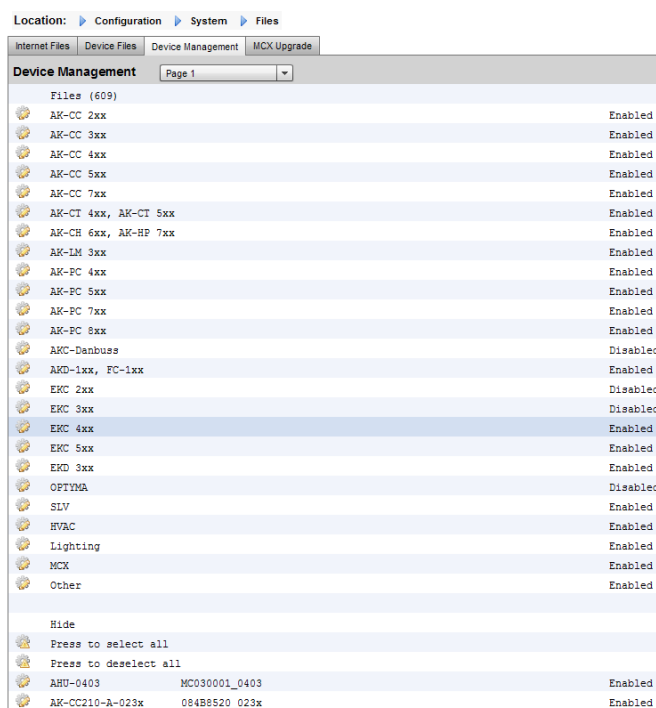

AK-SM 800 Device support guidelines

AK-SM 800 Field bus guidelines		
Field bus devices (generic)		Modbus Protocol Info (Baud rate, parity, data bits)
3rd Party Modbus devices	See notes	
3rd Party Lon devices	(120)	
Danfoss Modbus controller devices (EKC, AKCC, MCX)	120	PARITY_EVEN, 38400, DATA_8_BITS
Danfoss Lon controller devices	120	
Danfoss EKC, SLV, WattNode Modbus (Modbus)	120	PARITY_EVEN, 19200, DATA_8_BITS
Danfoss SNMP controller devices	160	
Danfoss Danbuss via PI-200 (max X4 PI-200 per front end)	120	
AK2 Multi-Case controllers (max per front end / no further generic devices allowed)	60	
Danfoss gas sensors (DGS)	50	PARITY_EVEN, 38400, DATA_8_BITS
Danfoss mix (Modbus/Lon/SNMP) devices	120	
Danfoss AK I/O		
Danfoss AK I/O Analog Inputs	256	
Danfoss AK I/O Analog Outputs	(256)	
Danfoss AK I/O Digital Inputs	256	
Danfoss AK I/O Relay Outputs	256	
Control Analog Inputs	256	
Control Analog Outputs	(256)	
Control Digital Inputs	256	
Control I/O Relay Outputs	256	
Total Digital points	256	
Total Analog points	256	
3 rd Party (Modbus)		
SLV	Contact factory	PARITY_EVEN, 19200, DATA_8_BITS
Carlo Garvazzi Power Meters (Modbus)	80	PARITY_NONE, 9600, DATA_8_BITS
Cuttler Hammer Lighting Panels (Modbus)		PARITY_NONE, 9600, DATA_8_BITS
ComTrol I/O support (via Modbus port)		"IO_SERIAL_FORCE_PARITY_HIGH, 19200, DATA_8_BITS PARITY_NONE, 19200, DATA_9_BITS"
Siemens Lighting Panel (Modbus)		PARITY_NONE, 38400, DATA_8_BITS
Veris Power Meter (Modbus)		PARITY_NONE, 9600, DATA_8_BITS
Square D Lighting Panel (Modbus)		PARITY_NONE, 19200, DATA_8_BITS
EC-Fan (Modbus)		PARITY_EVEN, 19200, DATA_8_BITS
WattNode Plus (Modbus)		PARITY_EVEN, 38400, DATA_8_BITS
Notes		
WattNode Plus Modbus is considered Danfoss Modbus		PARITY_EVEN, 38400, DATA_8_BITS
3rd Party Modbus devices requires factory validation to confirm capacity (parity/ baud rate/system capacity)		
Field bus and AK I/O capacities based on AK-SM 850 and 880 (AK-SM 820 has reduced device capacity)		
Maximum different controller types in use (active EDF) at one time is 20		

AK-SM 800 Recommended IT settings			
Port	Type	Use	User changeable
80	HTTP	Web browser/XML Interface	yes
20	FTP	FTP data transfer, used by RMT tool to update database and system graphics	yes
21	FTP	FTP data server transfer, used by RMT tool to update database and system graphics	yes
25	SMTP	Used to send e-mail alarms	yes
1041	Proprietary	AK-ST500 (service tool) access, allowing Service Tool tunneling to AK2 devices	no
3001	XML	Alarm port (alarms from unit to alarm receiver e.g. EM800)	yes

Glossary of terms

RMT	Remote Management Tool
Storeview Desktop	Desktop tool for remote control of SM800 series and export data
Viz	Visual file. Used in the RMT tool and sent to the AK-SM for graphic Site View
System View	Central page of AK-SM that displays all configured control points
Site View	Custom graphic page with mapped system parameters
AK I/O:	Danfoss AK Input / Output modules
Bd-Pt:	Board & Point address location
Alarm Levels:	Disabled = no alarm action Log Only = logs alarm in database - no external action Normal = Activate alarm output (once) Severe = Activate alarm output (repeat based on severe repeat time) Critical = Activate alarm output (repeat based on critical repeat time)
MAI	Master Application Image
CSI	Compressed Software Image
FAI	Factory Application Image
IP	Internet Protocol
EDF/ED3	Extended Device File (a file that represents the physical device)
CAT (seen in EDF list)	Category (1=Evap, 2=Pack, 8=HVAC, 16=Energy meter, 34=AKD102)
Relative schedule	When set a relative schedule will offset against the operating hours (set under config/time)Host
Communications	The connection (via Ethernet) of one or more AK-SM units. The connection between units is known as 'host network'
Danfoss	http://danfoss.com
Danfoss Software	http://food-retail.danfoss.com/knowledge-center/software/ak-sm-800/
Veris Industries™	http://www.veris.com/
Carlo Gavazzi™	http://www.carlogavazzi.com/
Continental Control Systems™	http://www.ccontrols.com/w/Home

ENGINEERING
TOMORROW

Danfoss

www.danfoss.com

ADAP-KOOL® Refrigeration Control Systems is a trademark of Danfoss A/S, www.danfoss.com

Danfoss can accept no responsibility for possible errors in catalogs, brochures, or other printed material. Danfoss reserves the right to alter its products without notice. This also applies to products already on order provided that alterations can be made without subsequent changes being necessary in specifications already agreed. All trademarks in this material are property of the respective companies. Danfoss and the Danfoss logotype are trademarks of Danfoss A/S. All rights reserved.